



坚持追求完美
Insisting on Pursuing Perfection

隔热型材系列 Thermal break Series

Guangdong Jma Aluminium Profile Factory Co., Ltd. is a comprehensive large size enterprise integrating research, design, production and sales of aluminium alloy profiles for building and industrial applications as well as windows, doors and curtain walls. The powerful comprehensive technology.

一、穿条系列

1、平开系列	
GR46系列隔热平开门	001-002
GR50B系列隔热平开窗	003-005
GR50C-6系列隔热内开窗	006-007
GR52-V系列隔热平开窗	008-011
GR52-VI系列隔热平开门	012-013
GRU55系列隔热推拉上悬、推拉折叠门	014-016
GR55系列隔热推拉折叠门	017-018
GRE55-IV系列隔热内开内倒窗	019-021
GR55B系列隔热平开窗	022-027
GR55-I系列隔热外开窗	028-031
GR55-II系列隔热外开窗	032-033
GR55-IV系列隔热平开门窗	034-040
GR55-V系列隔热内开对开门	041-042
GR55-VI系列隔热外开对开门	043-044
GR55-VII系列隔热平开窗	045-047
GRQ55A系列隔热平开门窗	048-050
GR60A系列隔热内开内倒/外开窗	051-053
GR60B系列隔热内开内倒/外开窗	054-056
GR60C系列隔热平开门	057-059
GR63-7系列隔热地弹门	060-061
GR65系列隔热地弹门	062-063
GR65A-7系列隔热内开窗	064-065
GR65B-8系列隔热平开门(带纱网一体门)	066-068
GR65B-9系列隔热平开窗	069-070
GR65系列隔热平开门窗	071-074
GR70系列隔热平开窗	075-078
GR70D系列隔热平开窗(20条)	079-082
GR70E5系列隔热平开窗(24条)	083-084
GR70E6系列隔热平开门(24条)	085-087
GR70系列隔热平开门窗	088-089
GR70A系列隔热平开门窗	090-092
GR70A-4系列隔热平开窗	093-094
GR75系列隔热平开门窗	095-097
GR80系列隔热外平开窗	098-099
GR90A-1系列隔热折叠门	100-101
2、新标准系列和24隔热条系列	
GR55-GR60-GR65系列隔热内开内倒窗(T=1.8-T=22mm-14.8条--20条--24条)	102-107
GR55-GR60-GR65系列隔热平开窗(T=1.8mm-14.8条--20条--24条)	108-114
GR55-GR60-GR65系列隔热平开门(T=2.2mm--14.8条--20条--24条)	115-121
GR60系列隔热平开窗(外开和内开)(T=1.4mm--24条)	122-124
GR60系列隔热平开门(T=2.0mm--24条)	125-126
GR63A系列隔热地弹门(T=2.2mm--14.8条)	127-128
GR65E系列隔热平开窗(T=1.4mm--14.8条)	129-130
GR65G系列隔热平开窗(外开和内开)(T=1.4mm--24条)	131-133
GR65系列隔热平开门窗(外开内窗和内开内窗)(T=1.8-T=2.2mm--24条)	134-139
GR66系列隔热平开窗(外开和内开)(T=1.8mm--26条)	140-142
GR68A系列隔热平开(T=18mm--24条)	143-144
GR70E9系列隔热多道密封平开窗(T=1.4mm--25条)	145-147
GR70F6系列隔热平开窗(外开内窗和内开内窗)(T=1.4mm--24条)	148-150
GR90D-GR95系列隔热推拉门(T=2.0mm--14.8条)	151-156
GR90系列隔热推拉立门(T=2.0mm--24条)	157-158
GR100B系列热推拉窗(T=1.4mm--24条)	159-161

GR105A4系列隔热推拉窗 (T=1.8mm--24条)	162-163
GR105A5 (两轨)-GR155 (三轨) 系列隔热拉门 (T=2.2mm--24条)	164-165
GR105A9系列隔热推拉窗 (T=1.4mm--24条)	166-167
GR105A系列隔热推拉门 (T=2.0mm--24条)	168-169
GR105B系列隔热推拉门 (T=2.0mm--24条)	170-171
间墙料及拼管系列	172-173

3、推拉系列

GRD613-I系列隔热推拉窗	174-175
GRD613-II系列隔热推拉窗	176-177
GRC72-2系列隔热推拉窗	178-179
GRC76-4系列隔热推拉门窗	180-182
GRD78系列隔热推拉门窗	183-185
GR80系列隔热推拉窗	186-187
GR80C系列隔热推拉窗(单O条)	188-189
GR83系列隔热推拉窗	190-191
GR83系列隔热推拉门	192-193
GR83A系列隔热推拉窗	194-197
GR86系列隔热推拉窗	198-199
GR88系列隔热推拉窗	200-201
GR90系列隔热推拉门	202-210
GR90系列隔热推拉门(三轨)	211-212
GR90A系列隔热推拉窗	213-214
GR95系列隔热推拉门窗	215-216
GR96系列隔热推拉窗	217-218
GR100B系列隔热推拉窗(24条)	219-220
GR110系列隔热推拉窗(三轨带纱网)	221-222
GR115系列隔热提升推拉门	223-224
GR120系列提升推拉门	224-226
GR120A系列提升推拉门	227-228
GR120系列隔热(重型)推拉门	229-230
GR180系列隔热提升推拉门(三轨带纱网)	231-232

二、注胶系列

1、推拉系列

ZJ75系列推拉门窗	233-235
ZJ80-3系列推拉窗	236-237
ZJ83系列推拉窗	238-240
ZJ85-2系列推拉窗	241-242
ZJ85-3系列推拉窗	243-245
ZJ88-4系列推拉窗	246-247
ZJ90系列推拉门窗	248-252
ZJ90-6系列推拉窗	253-254
ZJ83系列提拉窗	255-257
ZJ95系列推拉窗	258-259
ZJ95-1系列推拉门	260-261
ZJ120系列提升推拉门	262-263

2、平开系列

ZJ50系列平开门窗	264-266
ZJ52-1系列平开窗	267-268
ZJ55系列平开窗	269-273
ZJ55-2系列平开门	274-275
ZJ60系列平开窗	276-278

Insertion series

1.Casement series

Casement door sections GR46 series	001-002
Casement window sections GR50B series	003-005
Series GR50C-6 Open-out Casement Window	006-007
Casement window sections GR52-V series	008-011
Casement door sections GR52-VI series	012-013
Casement door sections GRU55 series	014-016
Casement door sections GR55 series	017-018
Casement window sections GRE55-IV series	019-021
Casement window sections GR55B series	022-027
Casement window sections GR55-I series	028-031
Casement window sections GR55-II series	032-033
Casement window and door sections GR55-IV series	034-040
Casement door sections GR55-V series	041-042
Casement door sections GR55-VI series	043-044
Casement window sections GR55-VII series	045-047
Casement window and door sections GRO55A series	048-050
Casement window sections GR60A series	051-053
Casement window sections GR60B series	054-056
Casement door sections GR60C series	057-059
Series GR63-7 Springdoor	060-061
Series GR65 Springdoor	062-063
Series GR65A-7 Open-out Casement Window	064-065
Series GR65B-8 Open-out Casement Door(with window screen)	066-068
Series GR65B-9 Open-out Window	069-070
Casement window sections GR65 series	071-074
Casement window sections GR70 series	075-078
Casement window sections GR70D series	079-082
Casement window sections GR70E5 series	083-084
Casement door sections GR70E6 series	085-087
Casement window and door sections GR70 series	088-089
Casement window and door sections GR70A series	090-092
Casement window sections GR70A-4 series	093-094
Casement window and door sections GR75 series	095-097
Casement window sections GR80 series	098-099
Series GR90A-I Folding Door	100-101

2.Series according to new GB standard Thermal-break Series with 24mm strips

Casement window sections GR55/60/65 series	102-107
Casement window sections GR55/60/65 series	108-114
Casement door sections GR55/60/65 series	115-121
Casement window sections GR60 series	122-124
Casement door sections GR55/60/65 series	125-126
Casement door sections GR63A series	127-128
Casement window sections GR65E series	129-130
Casement window sections GR65G series	131-133
Casement window and door sections GR65 series	134-139
Casement window sections GR66 series	140-142
Casement window sections GR68A series	143-144
Casement window sections GR70E9 series	145-147
Casement window sections GR70F6 series	148-150
Sliding door sections GR90D/95 series	151-156
Sliding door sections GR90 series	157-158
Sliding window sections GR100B series	159-161

Sliding window sections GR105A4 series	162-163
Sliding door sections GR105A5 series	164-165
Sliding window sections GR105A9 series	166-167
Sliding door sections GR105A series	168-169
Sliding door sections GR105B series	170-171

3.Sliding series

Sliding window section GRD613-I series	174-175
Sliding window section GRD613-II series	176-177
Sliding window section GRC72-2 series	178-179
Sliding window and door section GRC76-4 series	180-182
Sliding window and door section GRD78 series	183-185
Sliding window section GR80 series	186-187
Sliding window sections GR80C series	188-189
Sliding window sections GR83 series	190-191
Sliding door section GR83 series	192-193
Sliding window section GR83A series	194-197
Sliding window sections GR86 series	198-199
Sliding window section GR88 series	200-201
Sliding door section GR90 series	202-210
Sliding door sections GR90 series (Three rails)	211-212
Sliding window section GR90A series	213-214
Sliding window and door section GR95 series	215-216
Sliding window sections GR96 series	217-218
Sliding window sections GR100B series	219-220
Sliding window sections GR110 series	221-222
Lifting and sliding door sections GR115	223-224
Sliding doors sections GR120 series	224-226
Sliding doors sections GR120A series	227-228
Sliding door sections GR120 series	229-230
Series GR180 Sliding & Lifting Door(with 3 rails & window screen)	231-232

Fill-Debridge series

1.Sliding series	
Sliding window and door sections ZJ75 series	233-235
Sliding window sections ZJ80-3 series	236-237
Sliding window sections ZJ83 series	238-240
Sliding window sections ZJ85-2 series	241-242
Sliding window sections ZJ85-3 series	243-245
Sliding window sections ZJ85-4 series	246-247
Sliding window and door sections ZJ90 series	248-252
Sliding window sections ZJ90-6 series	253-254
Up-pull window sections ZJ83 series	255-257
Sliding window sections ZJ95 series	258-259
Sliding door sections ZJ95-1 series	260-261
Sliding door sections ZJ120 series	262-263

2.Casement series

Casement window and door sections ZJ50 series	264-266
Casement window sections ZJ52-1 series	267-268
Casement window sections ZJ55 series	269-273
Casement door sections ZJ55-2 series	274-275
Casement window sections ZJ60 series	276-278

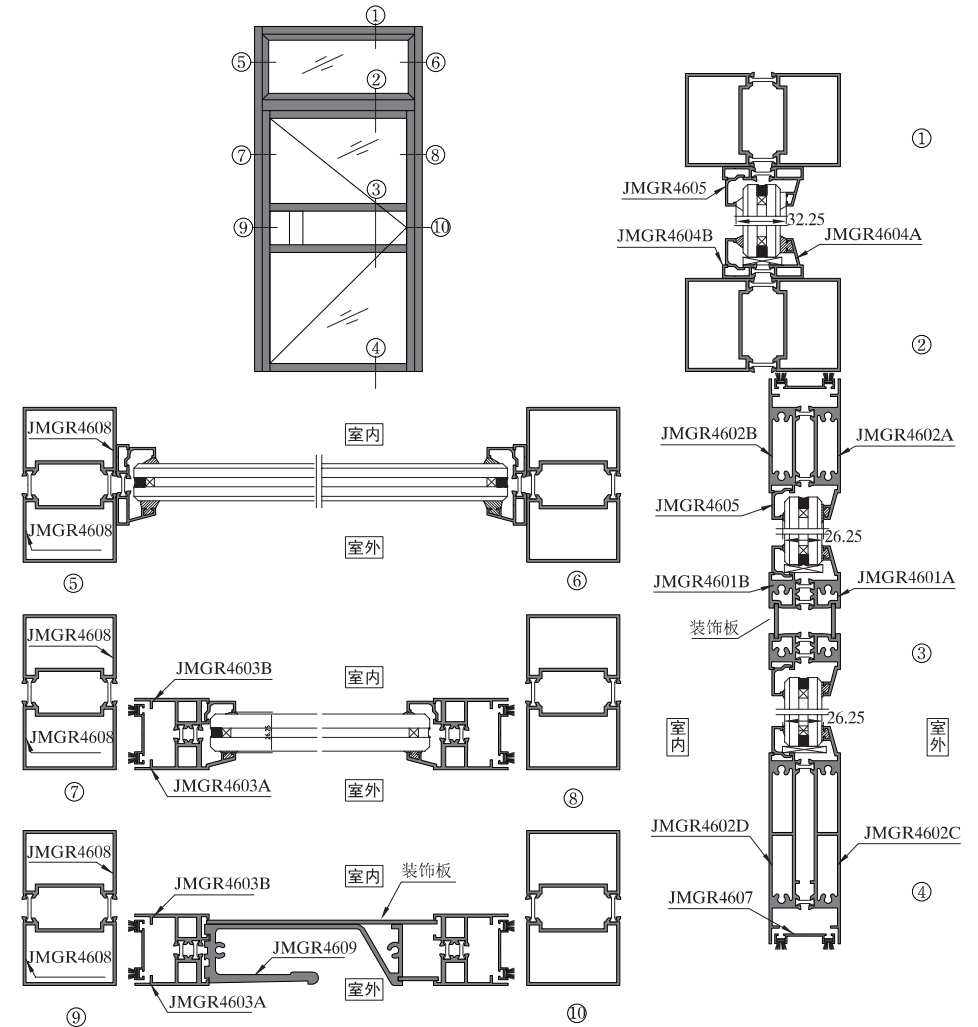

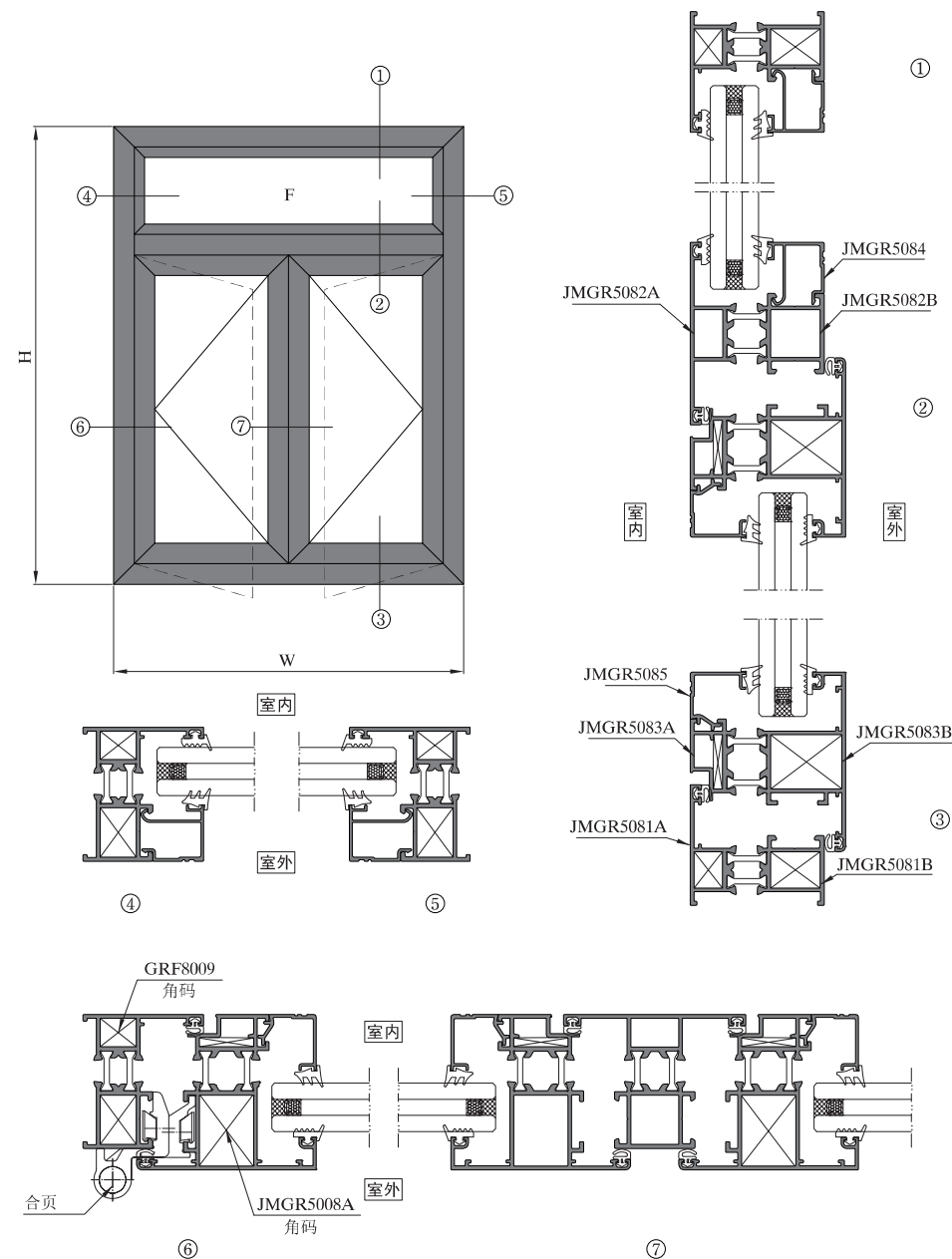

序号 S/N	型号理论重量 JMA Code & KG/M	型材图 Drawing	序号 S/N	型号理论重量 JMA Code & KG/M	型材图 Drawing	序号 S/N	型号理论重量 JMA Code & KG/M	型材图 Drawing
1	扇料 JMGR4601A JMGR4601B 1.577kg/m	压线配JMGR4605 JMGR4601A JMGR4601B 40 12 46 2	10	JMGR4609 3.357kg/m	2.8 37.7 127.5	19		
2	扇料 JMGR4602A JMGR4602B 2.838kg/m	压线配JMGR4605 JMGR4602A JMGR4602B 90.5 12 46 2	11			20		
3	扇料 JMGR4602C JMGR4602D 4.117kg/m	压线配JMGR4605 JMGR4602C JMGR4602D 140 12 46 2	12			21		
4	扇料 JMGR4603A JMGR4603B 1.565kg/m	压线配JMGR4605 JMGR4603A JMGR4603B 65 12 46 2	13			22		
5	JMGR4604A JMGR4604B 0.620kg/m	压线配JMGR4605 JMGR4604A JMGR4604B 25.5 14.8 52 1.5	14			23		
6	压线 JMGR4605 0.160kg/m	框压线玻璃开口32.25mm 扇压线玻璃开口26.25mm 6.9 20 1.5 12.5	15			24		
7	JMGR4606 2.000kg/m	70.5 100 2	16			25		
8	JMGR4607 0.237kg/m	1.5 38.5 6.2	17			26		
9	框料 JMGR4608 JMGR4608 2.642kg/m	100 18 2 2 60 JMGR4608 JMGR4608	18			27		

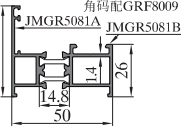
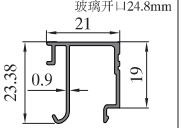
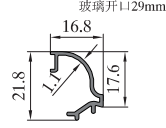
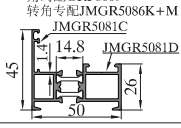
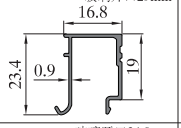
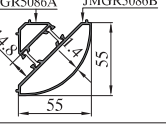
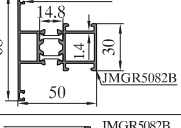
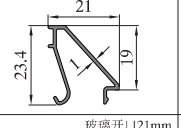
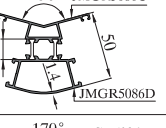
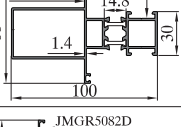
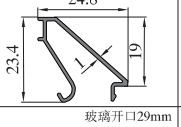
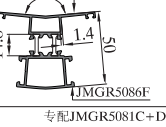
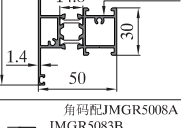
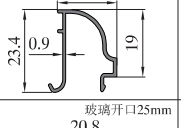
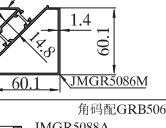
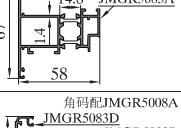
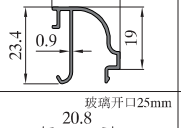
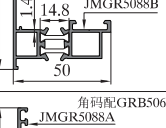
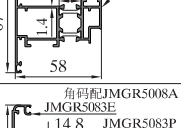
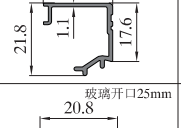
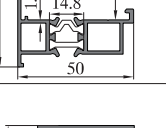
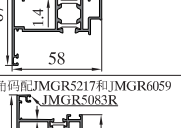
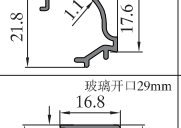
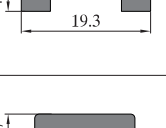
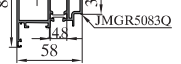

图中所示型材截面、装配、编号、尺寸及重量仅供参考。如有疑问，请向本公司查询。
Information above just for your reference. Please contact us if you have any questions, Thank you!

图中所示型材截面、装配、编号、尺寸及重量仅供参考。如有疑问，请向本公司查询。
Information above just for your reference. Please contact us if you have any questions, Thank you!

序号 S/N	型号理论重量 JMA Code & KG/M	型材图 Drawing	序号 S/N	型号理论重量 JMA Code & KG/M	型材图 Drawing	序号 S/N	型号理论重量 JMA Code & KG/M	型材图 Drawing
1	框料 JMGR5081A JMGR5081B 1.008kg/m		10	压线 JMGR5084 0.230kg/m		19	压线 JMGR5085C 0.161kg/m	
2	框料 JMGR5081C JMGR5081D 1.026kg/m		11	压线 JMGR5084A 0.203kg/m		20	转角 JMGR5086A JMGR5086B 1.360kg/m	
3	中挺 JMGR5082A JMGR5082B 1.202kg/m		12	压线 JMGR5084C 0.181kg/m		21	转角 JMGR5086C JMGR5086D 1.402kg/m	
4	中挺 JMGR5082B JMGR5082C 1.743kg/m		13	压线 JMGR5084D 0.193kg/m		22	转角 JMGR5086E JMGR5086F 1.286kg/m	
5	中挺 JMGR5082D JMGR5082E 1.267kg/m		14	压线 JMGR5084F 0.178kg/m		23	转角 JMGR5086K JMGR5086M 1.507kg/m	
6	扇料 JMGR5083A JMGR5083B 1.372kg/m		15	压线 JMGR5084G 0.205kg/m		24	转换件 JMGR5088A JMGR5088B 0.930kg/m	
7	扇料 JMGR5083D JMGR5083P 1.374kg/m		16	压线 JMGR5085 0.198kg/m		25	转换件 JMGR5088A JMGR5088C 0.910kg/m	
8	扇料 JMGR5083E JMGR5083P 1.312kg/m		17	压线 JMGR5085A 0.174kg/m		26	连杆 JMGR5507A 0.153kg/m	
9	扇料 JMGR5083R JMGR5083Q 2.068kg/m		18	压线 JMGR5085B 0.185kg/m		27	连杆 JMGR6037N 0.161kg/m	

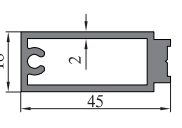
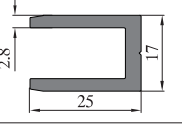
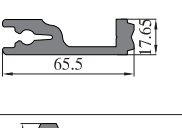
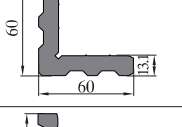
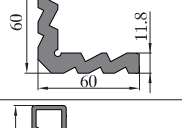
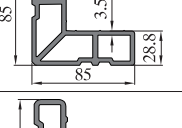
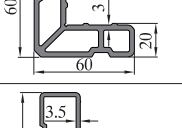
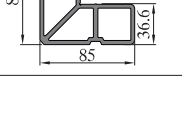



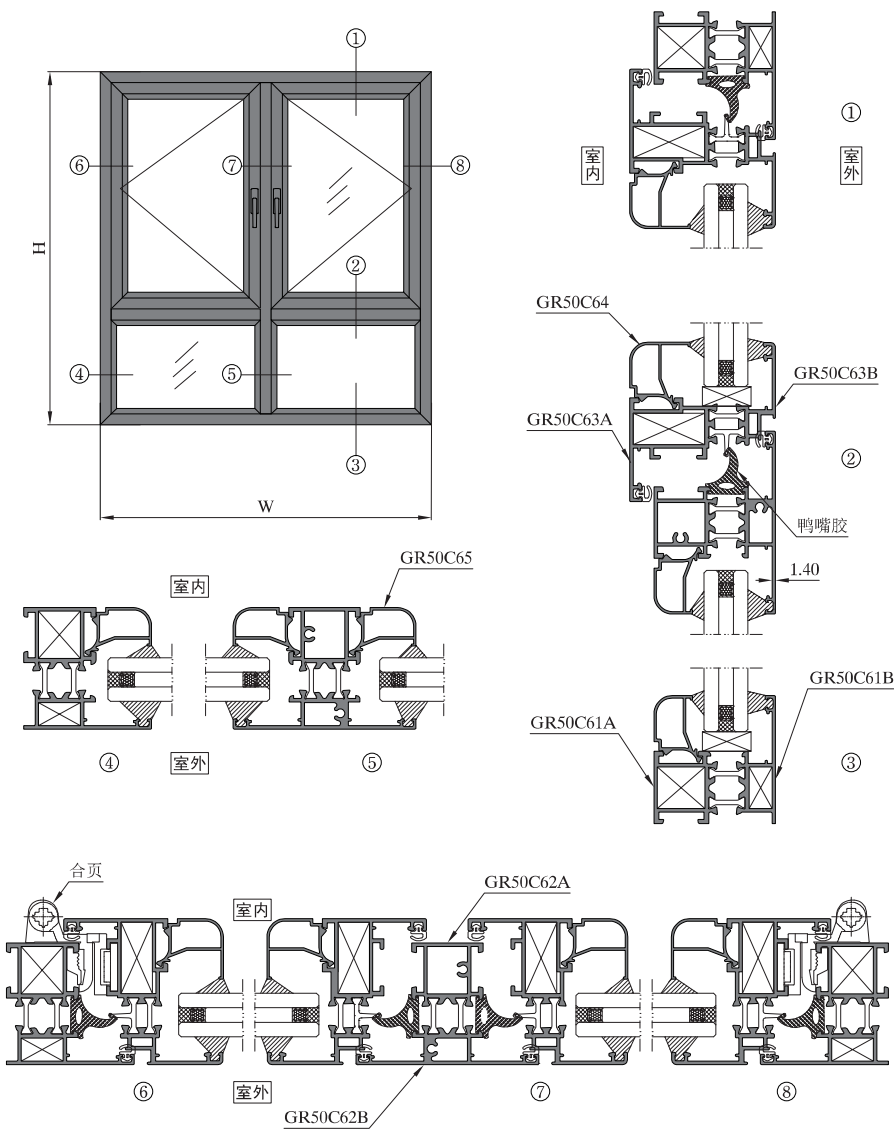

序号 S/N	型号理论重量 JMA Code & KG/M	型材图 Drawing	序号 S/N	型号理论重量 JMA Code & KG/M	型材图 Drawing	序号 S/N	型号理论重量 JMA Code & KG/M	型材图 Drawing
28	中挺连接件 JMGR5087 0.860kg/m		37			46		
29	中挺连接件 JMGR6037A 0.522kg/m		38			47		
30	中挺连接件 JMGR5267D 1.745kg/m		39			48		
31	角码 GRF8009 3.525kg/m		40			49		
32	角码 GRB506 2.991kg/m		41			50		
33	角码 JMGR5217 4.264kg/m		42			51		
34	角码 JMGR5008A 2.381kg/m		43			52		
35	角码 JMGR6059 4.458kg/m		44			53		
36			45			54		

图中所示型材截面、装配、编号、尺寸及重量仅供参考。如有疑问，请向本公司查询。
 Information above just for your reference. Please contact us if you have any questions, Thank you!

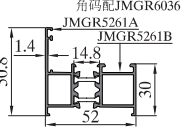
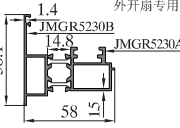
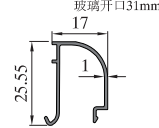
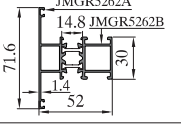
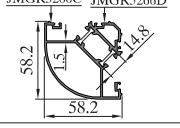
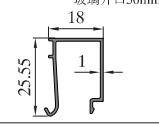
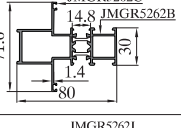
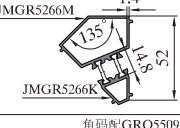
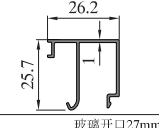
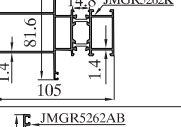
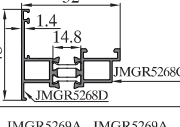
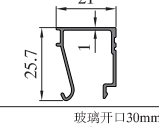
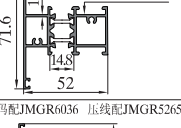
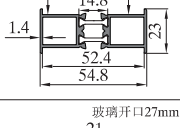
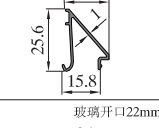
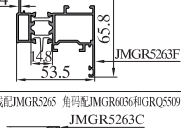
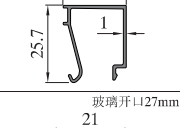
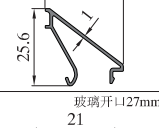
图中所示型材截面、装配、编号、尺寸及重量仅供参考。如有疑问，请向本公司查询。
 Information above just for your reference. Please contact us if you have any questions, Thank you!

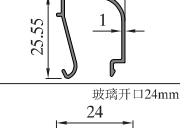
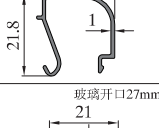
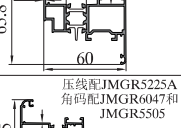
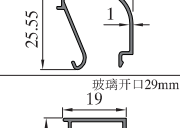
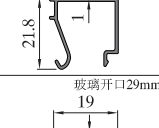

序号 S/N	型号理论重量 JMA Code & KG/M	型材图 Drawing	序号 S/N	型号理论重量 JMA Code & KG/M	型材图 Drawing	序号 S/N	型号理论重量 JMA Code & KG/M	型材图 Drawing
1	框料 GR50C61A GR50C61B 1.191kg/m		10			19		
2	中挺 GR50C62A GR50C62B 1.413kg/m		11			20		
3	扇料 GR50C63A GR50C63B 1.254kg/m		12			21		
4	压线 GR50C64 0.278kg/m		13			22		
5	压线 GR50C65 0.251kg/m		14			23		
6			15			24		
7			16			25		
8			17			26		
9			18			27		

序号 S/N	型号理论重量 JMA Code & KG/M	型材图 Drawing	序号 S/N	型号理论重量 JMA Code & KG/M	型材图 Drawing	序号 S/N	型号理论重量 JMA Code & KG/M	型材图 Drawing
1	框料 JMGR5261A JMGR5261B 1.116kg/m		10	假中挺 JMGR5230A JMGR5230B 1.265kg/m	外开扇专用 	19	框压线 JMGR5264D 0.191kg/m	
2	中挺 JMGR5262A JMGR5262B 1.274kg/m		11	90° 转角 JMGR5266C JMGR5266D 1.542kg/m		20	框压线 JMGR5264F 0.208kg/m	
3	中挺 JMGR5262B JMGR5262C 1.585kg/m		12	135° 转角 JMGR5266K JMGR5266M 1.017kg/m		21	框压线 JMGR5264G 0.251kg/m	
4	中挺 JMGR5262J JMGR5262K 2.079kg/m		13	转换料 JMGR5268C JMGR5268D 0.928kg/m	角码配GRO5509 	22	框压线 JMGR5264H 0.230kg/m	
5	中挺 JMGR5262AB JMGR5262BC 1.346kg/m		14	拼管 JMGR5269A JMGR5269A 0.838kg/m		23	框压线 JMGR5264L 0.180kg/m	
6	内开扇 JMGR5263A JMGR5263F 1.261kg/m	角码配JMGR6036 压线配JMGR5265 	15	框压线 JMGR5264 0.222kg/m		24	框压线 JMGR5264M 0.203kg/m	
7	内开扇 JMGR5263C JMGR5263D 1.415kg/m	压线配JMGR5265 角码配JMGR6036/RGRQ509 	16	框压线 JMGR5264A 0.213kg/m		25	内开扇压线 JMGR5265 0.188kg/m	
8	内开扇 JMGR5263C JMGR5263F 1.367kg/m	角码配JMGR6036 压线配JMGR5265 	17	框压线 JMGR5264B 0.218kg/m		26	内开扇压线 JMGR5265A 0.198kg/m	
9	外开扇 JMGR6083A JMGR5223B 1.444kg/m	压线配JMGR5225A 角码配JMGR6047和 JMGR5505 JMGR5223B JMGR6083A 	18	框压线 JMGR5264C 0.212kg/m		27	内开扇压线 JMGR5265B 0.190kg/m	

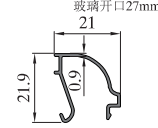
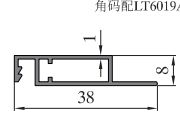
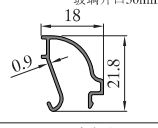
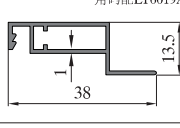
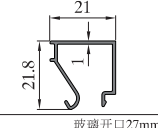
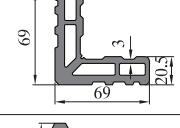
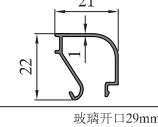
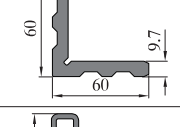
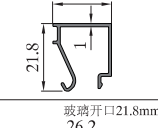
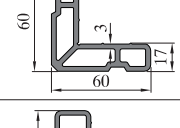
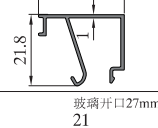
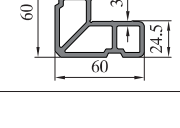
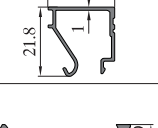
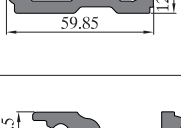
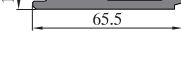
序号 S/N	型号理论重量 JMA Code & KG/M	型材图 Drawing	序号 S/N	型号理论重量 JMA Code & KG/M	型材图 Drawing	序号 S/N	型号理论重量 JMA Code & KG/M	型材图 Drawing
28	内开扇压线 JMGR5204 0.172kg/m		37	纱窗 JMGR6098 0.238kg/m	角码配LT6019A 	46		
29	外开扇压线 JMGR5225 0.164kg/m	玻璃开口30mm 	38	纱窗 JMGR6098A 0.254kg/m	角码配LT6019A 	47		
30	外开扇压线 JMGR5225A 0.201kg/m	玻璃开口27mm 	39	角码 JMGR5505D 4.125kg/m		48		
31	外开扇压线 JMGR5225B 0.192kg/m	玻璃开口27mm 	40	角码 GRO5509 2.690kg/m		49		
32	外开扇压线 JMGR5225C 0.192kg/m	玻璃开口29mm 	41	角码 JMGR6036 2.278kg/m		50		
33	外开扇压线 JMGR5225D 0.228kg/m	玻璃开口21.8mm 	42	角码 JMGR6047 2.502kg/m		51		
34	外开扇压线 JMGR5225E 0.210kg/m	玻璃开口27mm 	43			52		
35	中挺连接件 JMGR5267C 1.052kg/m		44			53		
36	中挺连接件 JMGR5267D 1.745kg/m		45			54		

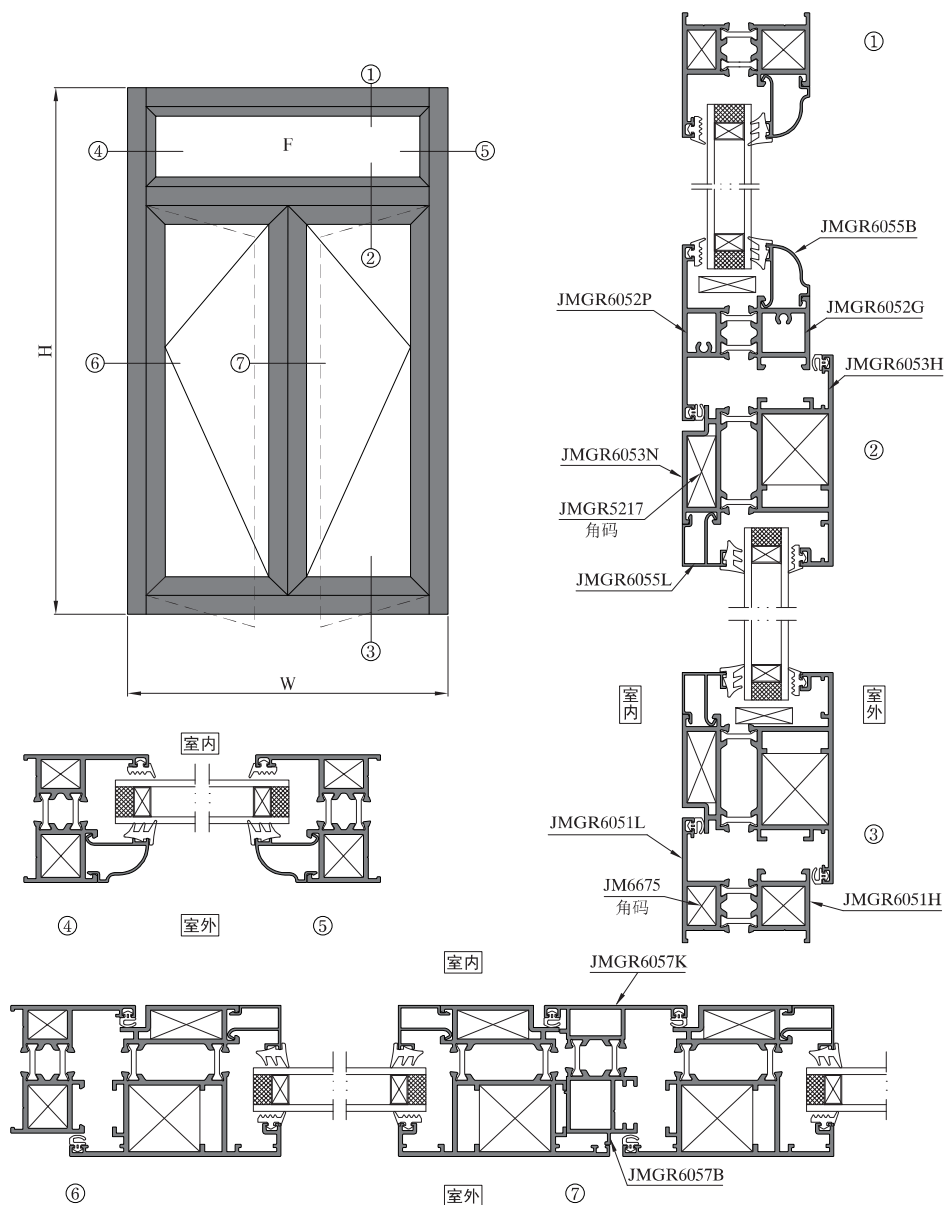

序号 S/N	型号理论重量 JMA Code & KG/M	型材图 Drawing	序号 S/N	型号理论重量 JMA Code & KG/M	型材图 Drawing	序号 S/N	型号理论重量 JMA Code & KG/M	型材图 Drawing
1	框料 JMGR6051L JMGR6051H 1.344kg/m		10	JMGR6061C 0.213kg/m		19		
2	中挺 JMGR6052G JMGR6052P 1.594kg/m		11			20		
3	外开扇 JMGR6053H JMGR6053N 2.231kg/m		12			21		
4	假中挺 JMGR6057B JMGR6057K 1.283kg/m		13			22		
5	角码 JMGR5217 4.264kg/m		14			23		
6	角码 JM6675 3.251kg/m		15			24		
7	角码 GRQ5509 2.690kg/m		16			25		
8	框压线 JMGR6055B 0.198kg/m		17			26		
9	扇压线 JMGR6055L 0.206kg/m		18			27		

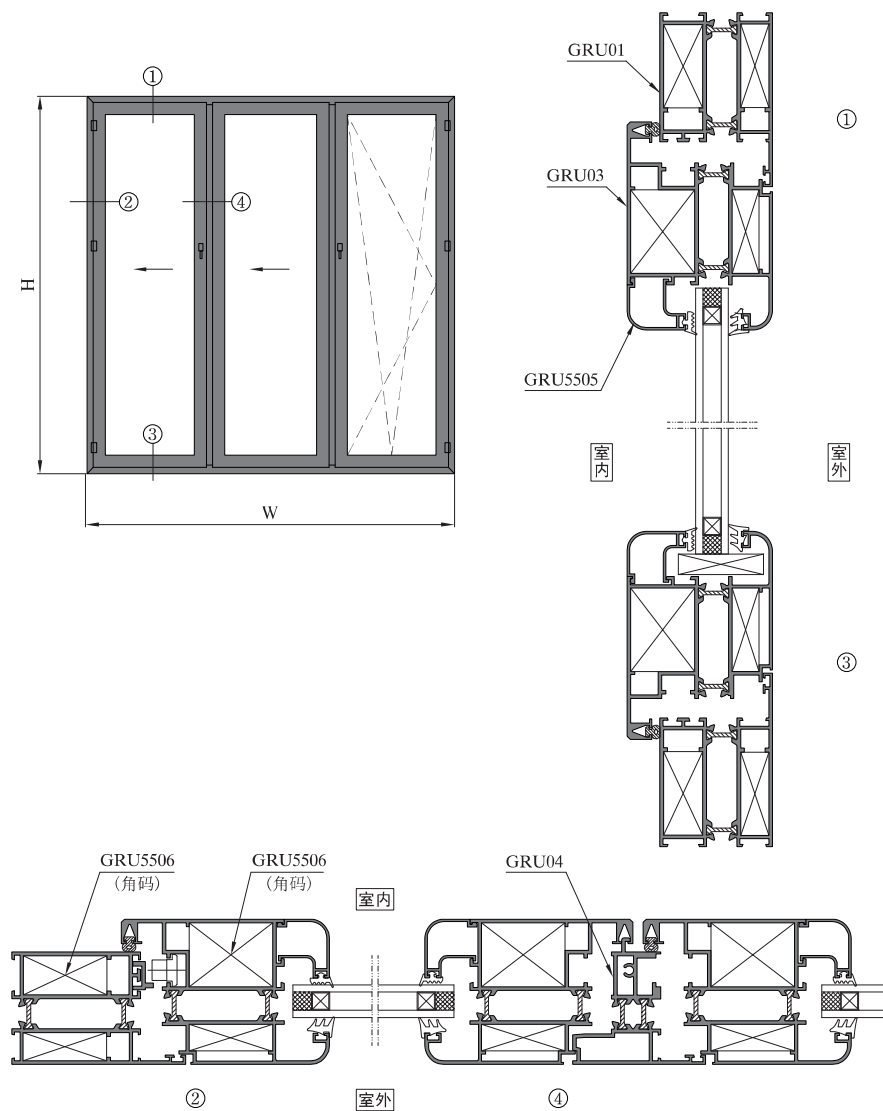
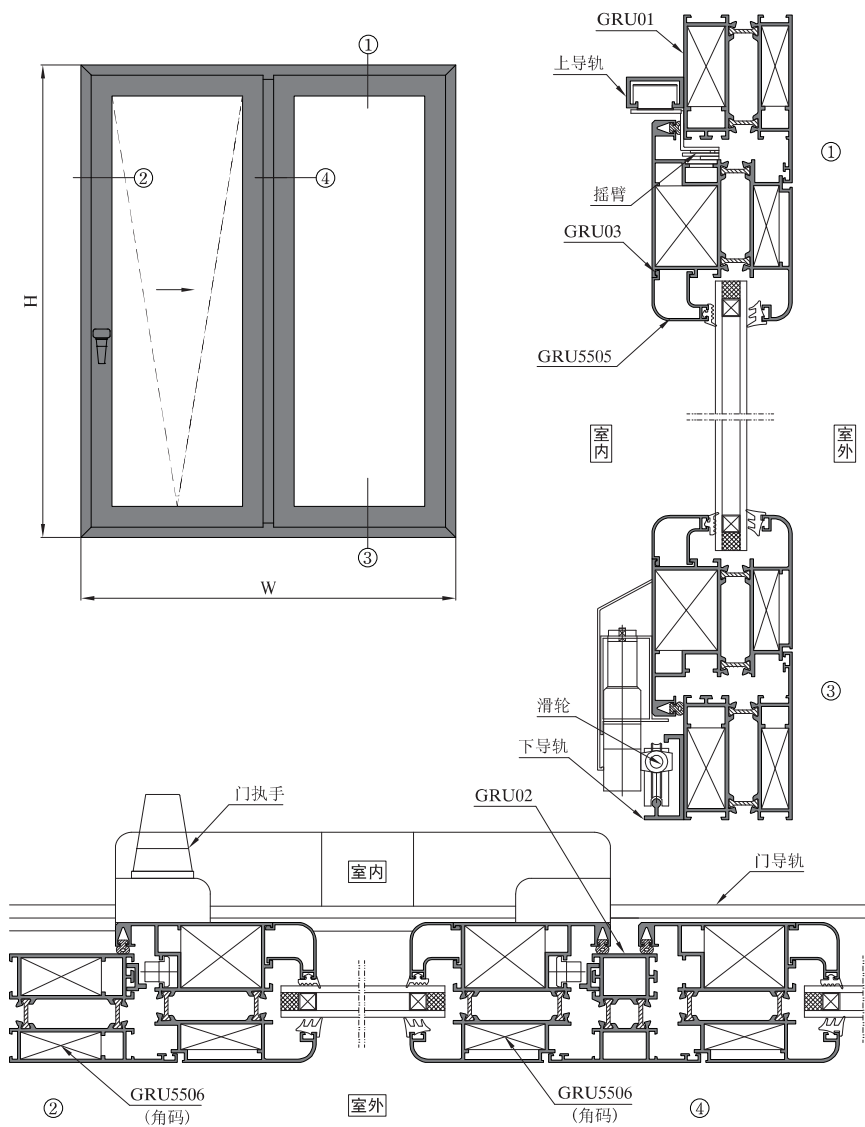

序号 S/N	型号理论重量 JMA Code & KG/M	型材图 Drawing	序号 S/N	型号理论重量 JMA Code & KG/M	型材图 Drawing	序号 S/N	型号理论重量 JMA Code & KG/M	型材图 Drawing
1	框料 GRU5501C GRU5501D 2.154kg/m		10	外开扇压线 GRU5505B 0.260kg/m		19		
2	中挺 GRU5502 GRU5501B 1.645kg/m		11	固定压线 GRU5507 0.283kg/m		20		
3	内开扇 GRU5503C GRU5503D 2.484kg/m		12	内开扇压线 GRU5508 0.261kg/m		21		
4	外开扇 GRU5503G GRU5503H 2.360kg/m		13			22		
5	假中挺 GRU5504A GRU5504B 1.591kg/m		14			23		
6	转换料 GRU5504C GRU5504D 1.229kg/m		15			24		
7	角码 GRU5506 5.869kg/m		16			25		
8	内开扇压线 GRU5505 0.312kg/m		17			26		
9	外开扇压线 GRU5505A 0.327kg/m		18			27		

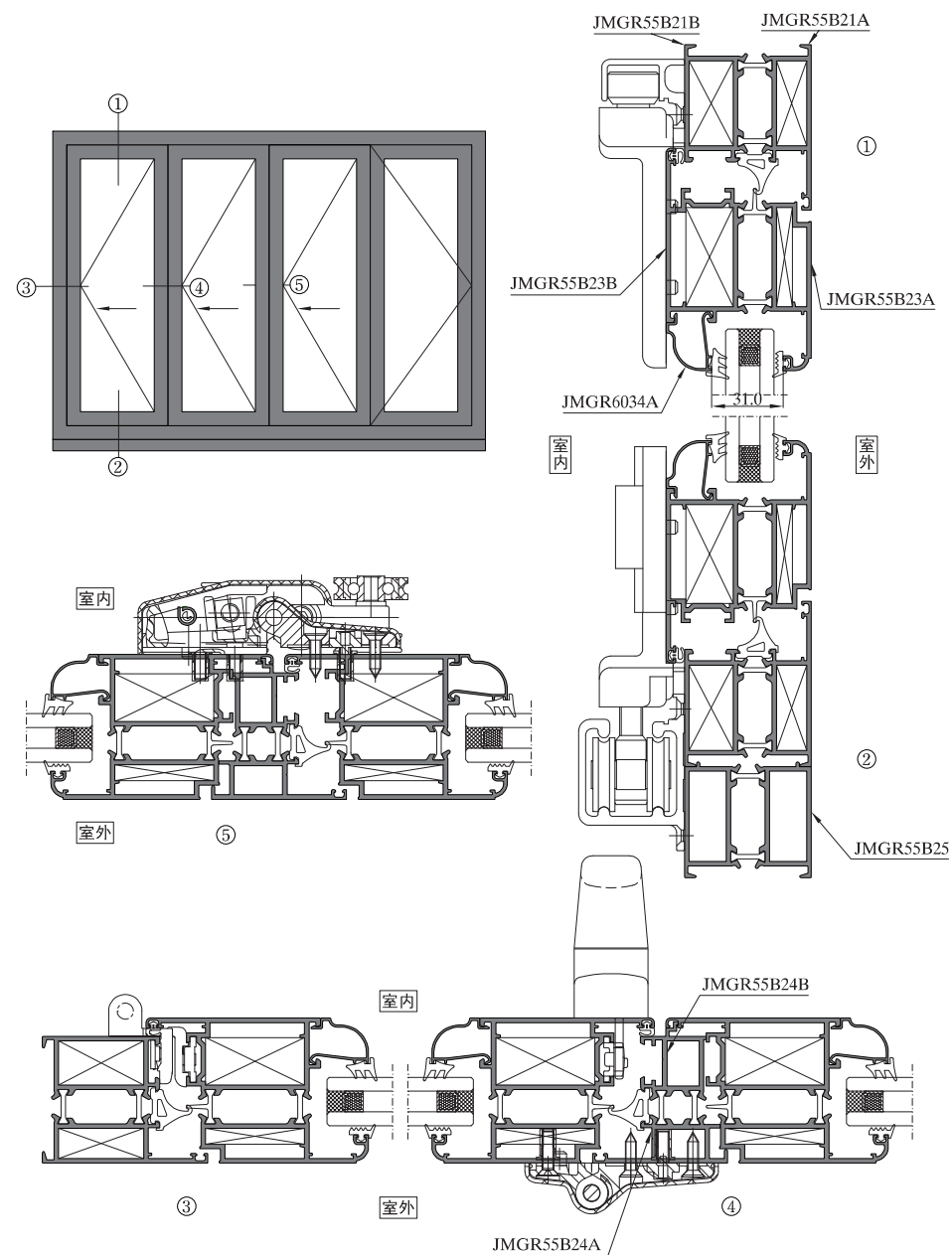

图中所示型材截面、装配、编号、尺寸及重量仅供参考。如有疑问，请向本公司查询。
Information above just for your reference. Please contact us if you have any questions, Thank you!

图中所示型材截面、装配、编号、尺寸及重量仅供参考。如有疑问，请向本公司查询。
Information above just for your reference. Please contact us if you have any questions, Thank you!

序号 S/N	型号理论重量 JMA Code & KG/M	型材图 Drawing	序号 S/N	型号理论重量 JMA Code & KG/M	型材图 Drawing	序号 S/N	型号理论重量 JMA Code & KG/M	型材图 Drawing
1	框料 JMGR55B21A JMGR55B21B 1.945kg/m	角码配JMGR6059 JMGR55B21A JMGR55B21B	10	框/扇压线 JMGR6034C 0.247kg/m	玻璃开口27mm 23.8	19	框/扇压线 JMGR6034YA 0.210kg/m	玻璃开口29mm 21.8
2	框料 JMGR55B25 JMGR55B25 1.745kg/m	JMGR55B25 JMGR55B25	11	框/扇压线 JMGR6034D 0.217kg/m	玻璃开口27mm 23.8	20	框/扇压线 JMGR6034YE 0.220kg/m	玻璃开口27mm 23.8
3	内开扇 JMGR55B23A JMGR55B23B 2.418kg/m	角码配JMGR5505C JMGR55B23B JMGR55B23A	12	框/扇压线 JMGR6034N 0.197kg/m	玻璃开口29.6mm 21.2	21	框/扇压线 JMGR6034CD 0.207kg/m	玻璃开口26mm 24.8
4	假中挺 JMGR55B24A JMGR55B24B 1.599kg/m	JMGR55B24A JMGR55B24B	13	框/扇压线 JMGR6034Q 0.219kg/m	玻璃开口32mm 18.8	22	框/扇压线 JMGR6034YC 0.187kg/m	玻璃开口30mm 20.8
5	角码 JMGR5505C 7.855kg/m	108 5 42.7 108	14	框/扇压线 JMGR6034T 0.205kg/m	玻璃开口37mm 13.8	23	框/扇压线 JMGR6035 0.219kg/m	玻璃开口24mm 26.8
6	角码 JMGR6059 4.458kg/m	85 3.5 36.6 85	15	框/扇压线 JMGR6034Y 0.201kg/m	玻璃开口32mm 18.8	24	框/扇压线 JMGR6035H 0.192kg/m	玻璃开口34mm 16.8
7	框/扇压线 JMGR6034 0.257kg/m	玻璃开口24mm 26.8	16	框/扇压线 JMZJ5504A10 0.215kg/m	玻璃开口29mm 21.8	25		
8	框/扇压线 JMGR6034A 0.189kg/m	玻璃开口31mm 19.8	17	框/扇压线 JMZJ550410 0.241kg/m	玻璃开口24mm 26.8	26		
9	框/扇压线 JMGR6034B 0.213kg/m	玻璃开口27mm 23.8	18	框/扇压线 JMGR6034AE 0.237kg/m	玻璃开口24mm 26.8	27		

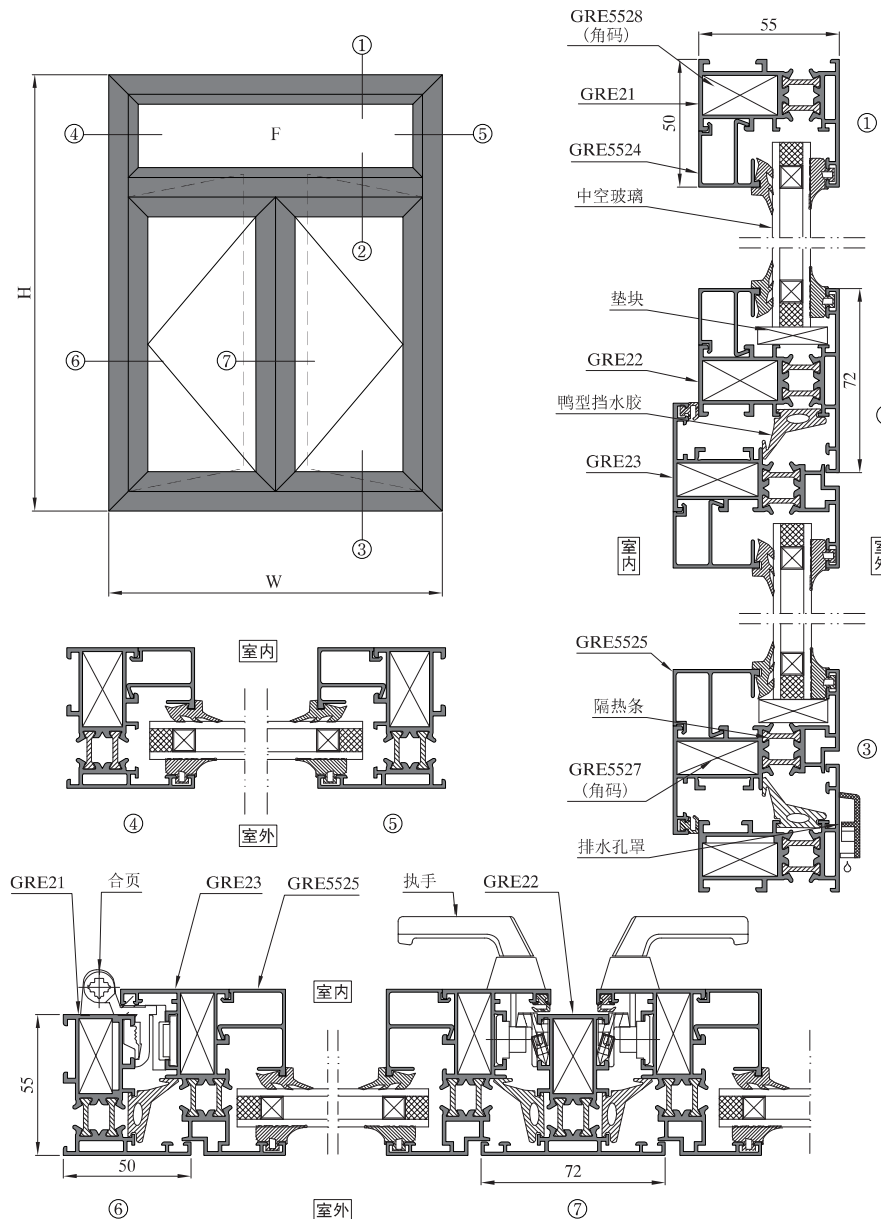

图中所示型材截面、装配、编号、尺寸及重量仅供参考。如有疑问，请向本公司查询。
Information above just for your reference. Please contact us if you have any questions, Thank you!

图中所示型材截面、装配、编号、尺寸及重量仅供参考。如有疑问，请向本公司查询。
Information above just for your reference. Please contact us if you have any questions, Thank you!

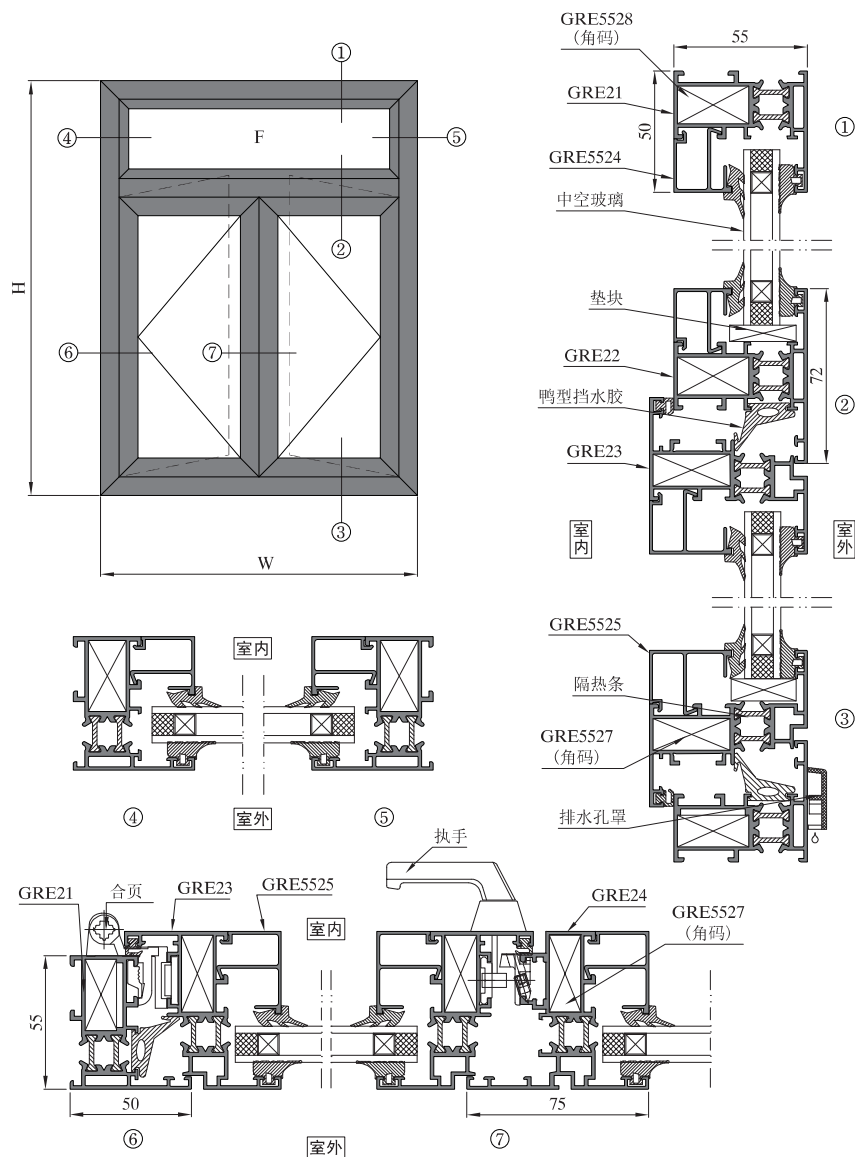

序号 S/N	型号理论重量 JMA Code & KG/M	型材图 Drawing	序号 S/N	型号理论重量 JMA Code & KG/M	型材图 Drawing	序号 S/N	型号理论重量 JMA Code & KG/M	型材图 Drawing
1	框料 GRE5511A GRE5521B 1.270kg/m		10	角码 GRE5528A 1.993kg/m		19		
2	中挺 GRE5512A GRE5522B 1.439kg/m		11			20		
3	假中挺 GRE5514A GRE5526B 1.631kg/m		12			21		
4	内开扇 GRE5513A GRE5523B 1.415kg/m		13			22		
5	转角 GRE5529A GRE5529B 2.048kg/m		14			23		
6	扇压线 GRE5525 0.368kg/m		15			24		
7	框压线 GRE5524 0.334kg/m		16			25		
8	角码 GRE5527 1.315kg/m		17			26		
9	角码 GRE5528 1.966kg/m		18			27		

序号 S/N	型号理论重量 JMA Code & KG/M	型材图 Drawing	序号 S/N	型号理论重量 JMA Code & KG/M	型材图 Drawing	序号 S/N	型号理论重量 JMA Code & KG/M	型材图 Drawing
1	框料 JMGR6031A JMGR6031B 1.230kg/m		10	外开扇 JMGR6043A15 JMGR6033C 1.598kg/m		19	转角 JMGR6032K JMGR6032J 1.406kg/m	
2	框料 JMGR6031AP14 JMGR6031BR14 1.238kg/m		11	外开扇 JMGR6043D JMGR6033C 1.587kg/m		20	转角 JMGR6032M JMGR6032L 1.591kg/m	
3	中挺 JMGR6032U JMGR6032TD 1.450kg/m		12	外开扇 JMGR6043Z JMGR6033CA 1.648kg/m		21	转角 JMGR6032N JMGR6032H 1.398kg/m	
4	中挺 JMGR6032A JMGR6032B 1.382kg/m		13	内开扇 JMGR6033AM JMGR6033BJ 1.857kg/m		22	转角 JMGR6038M JMGR6038L 1.338kg/m	
5	中挺 JMGR6032C15 JMGR6032B 1.896kg/m		14	转换框 JMGR6039A JMGR6044B 1.120kg/m		23	转角 JMGR6038B JMGR6038A 1.576kg/m	
6	中挺 JMGR6032B JMGR6032CD 1.985kg/m		15	转角 JMGR6032E JMGR6032D 1.360kg/m		24	转角 JMGR6038C JMGR6038A 1.486kg/m	
7	中挺 JMGR6032B20 JMGR6032CJ 2.352kg/m		16	转角 JMGR6032G JMGR6032F 1.368kg/m		25	转角 JMGR6038H JMGR6038A 1.663kg/m	
8	内开扇 JMGR6033A JMGR6033B 1.494kg/m		17	转角 JMGR6032I JMGR6032H 1.366kg/m		26	转角 JMGR6038EE JMGR6038FF 2.041kg/m	
9	内开扇 JMGR6033B JMGR6033S 1.512kg/m		18	转角 JMGR6038F JMGR6038G 2.062kg/m		27	转角 JMGR6032CF JMGR6032CE 1.533kg/m	

序号 S/N	型号理论重量 JMA Code & KG/M	型材图 Drawing	序号 S/N	型号理论重量 JMA Code & KG/M	型材图 Drawing	序号 S/N	型号理论重量 JMA Code & KG/M	型材图 Drawing
28	转角 JMGR6038U JMGR6038T 1.291kg/m		37	角码 JMGR6036 2.278kg/m		46	框压线 内开扇压线 JMGR6034 0.257kg/m	
29	转角 JMGR6038X JMGR6038Y 1.245kg/m		38	角码 GRU5506 5.869kg/m		47	框压线 内开扇压线 JMGR6034AC 0.267kg/m	
30	转角 JMGR6038CC JMGR6038DD 2.077kg/m		39	中挺连接件 JMGR5507 1.913kg/m		48	框压线 内开扇压线 JMGR6034C 0.247kg/m	
31	拼管 JMGR6038S14 JMGR6038S14 0.976kg/m		40	中挺连接件 JMGR5507B 0.697kg/m		49	框压线 内开扇压线 JMGR6034CA 0.262kg/m	
32	转角 JMGR6038V JMGR6038W 1.399kg/m		41	中挺连接件 JMGR6037G 0.796kg/m		50	框压线 内开扇压线 JMGR6034E 0.254kg/m	
33	外开假中挺 JMGR6033Y JMGR6033Z 1.244kg/m		42	中挺连接件 JMGR6037A 0.522kg/m		51	框压线 内开扇压线 JMGR6034EA 0.288kg/m	
34	内开假中挺 JMGR6039Q JMGR6039O JMGR6039R 1.386kg/m		43	中挺连接件 JMGR6037 0.333kg/m		52	框压线 内开扇压线 JMGR6034K 0.256kg/m	
35	角码 LT6019 5.668kg/m		44	连杆 JMGR5507A 0.153kg/m		53	框压线 内开扇压线 JMGR6034Q 0.219kg/m	
36	角码 JMGR6047 2.502kg/m		45	拼条 JMGR6038AA 0.151kg/m		54	框压线 内开扇压线 JMGR6034QA 0.222kg/m	

图中所示型材截面、装配、编号、尺寸及重量仅供参考。如有疑问，请向本公司查询。
Information above just for your reference. Please contact us if you have any questions, Thank you!

图中所示型材截面、装配、编号、尺寸及重量仅供参考。如有疑问，请向本公司查询。
Information above just for your reference. Please contact us if you have any questions, Thank you!

序号 S/N	型号理论重量 JMA Code & KG/M	型材图 Drawing	序号 S/N	型号理论重量 JMA Code & KG/M	型材图 Drawing	序号 S/N	型号理论重量 JMA Code & KG/M	型材图 Drawing
55	框压线 内开扇压线 JMGR6034R 0.274kg/m		64	框压线 内开扇压线 JMGR6034B 0.213kg/m		73	外开扇压线 JMGR6035A 0.220kg/m	
56	框压线 内开扇压线 JMGR6034T 0.205kg/m		65	框压线 内开扇压线 JMGR6034D 0.217kg/m		74	外开扇压线 JMGR6035B 0.202kg/m	
57	框压线 内开扇压线 JMGR6034AE 0.237kg/m		66	框压线 内开扇压线 JMGR6034N 0.197kg/m		75	外开扇压线 JMGR6035C 0.213kg/m	
58	框压线 内开扇压线 JMGR6034Y 0.201kg/m		67	框压线 内开扇压线 JMGR6034J 0.298kg/m		76	外开扇压线 JMGR6035G 0.217kg/m	
59	框压线 内开扇压线 JMGR6034YA 0.210kg/m		68	框压线 内开扇压线 JMGR6035 0.219kg/m		77	外开扇压线 JMGR6035J 0.192kg/m	
60	框压线 内开扇压线 JMGR6034YE 0.220kg/m		69	框压线 内开扇压线 JMGR6035D 0.224kg/m		78	外开扇压线 JMGR6035K 0.224kg/m	
61	框压线 内开扇压线 JMGR6034CD 0.207kg/m		70	框压线 内开扇压线 JMGR6035H 0.192kg/m		79	外开扇压线 JMGR6035P 0.298kg/m	
62	框压线 内开扇压线 JMGR6034YC 0.187kg/m		71	框压线 内开扇压线 JMZJ5504A10 0.215kg/m		80	外开扇压线 JMGR6035X 0.203kg/m	
63	框压线 内开扇压线 JMGR6034A 0.189kg/m		72	框压线 内开扇压线 JMZJ550410 0.241kg/m		81	外开扇压线 JMGR6035Y 0.237kg/m	

序号 S/N	型号理论重量 JMA Code & KG/M	型材图 Drawing	序号 S/N	型号理论重量 JMA Code & KG/M	型材图 Drawing	序号 S/N	型号理论重量 JMA Code & KG/M	型材图 Drawing
82	外开扇压线 JMGR6035E 0.244kg/m		91			100		
83	外开扇压线 JMGR6035F 0.253kg/m		92			101		
84	外开扇压线 JMGR6035L 0.262kg/m		93			102		
85	外开扇压线 JMGR6035LA 0.281kg/m		94			103		
86	外开扇压线 JMGR6035LD 0.233kg/m		95			104		
87	外开扇压线 JMGR6035W 0.232kg/m		96			105		
88	外开扇压线 JMGR6035CF 0.228kg/m		97			106		
89	外开扇压线 JMGR6035LE 0.230kg/m		98			107		
90	外开扇压线 JMGR6035CE 0.188kg/m		99			108		

图中所示型材截面、装配、编号、尺寸及重量仅供参考。如有疑问，请向本公司查询。
 Information above just for your reference. Please contact us if you have any questions, Thank you!

图中所示型材截面、装配、编号、尺寸及重量仅供参考。如有疑问，请向本公司查询。
 Information above just for your reference. Please contact us if you have any questions, Thank you!

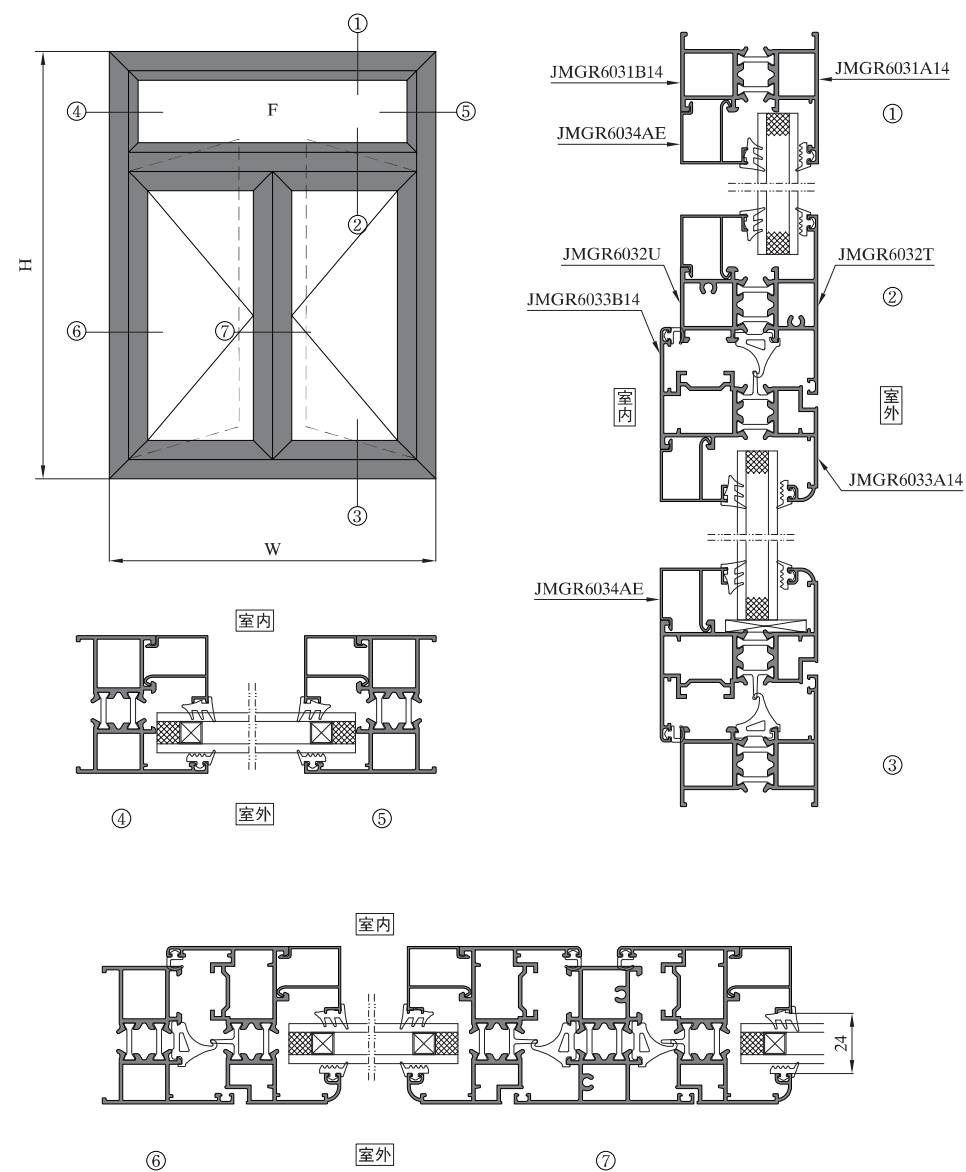
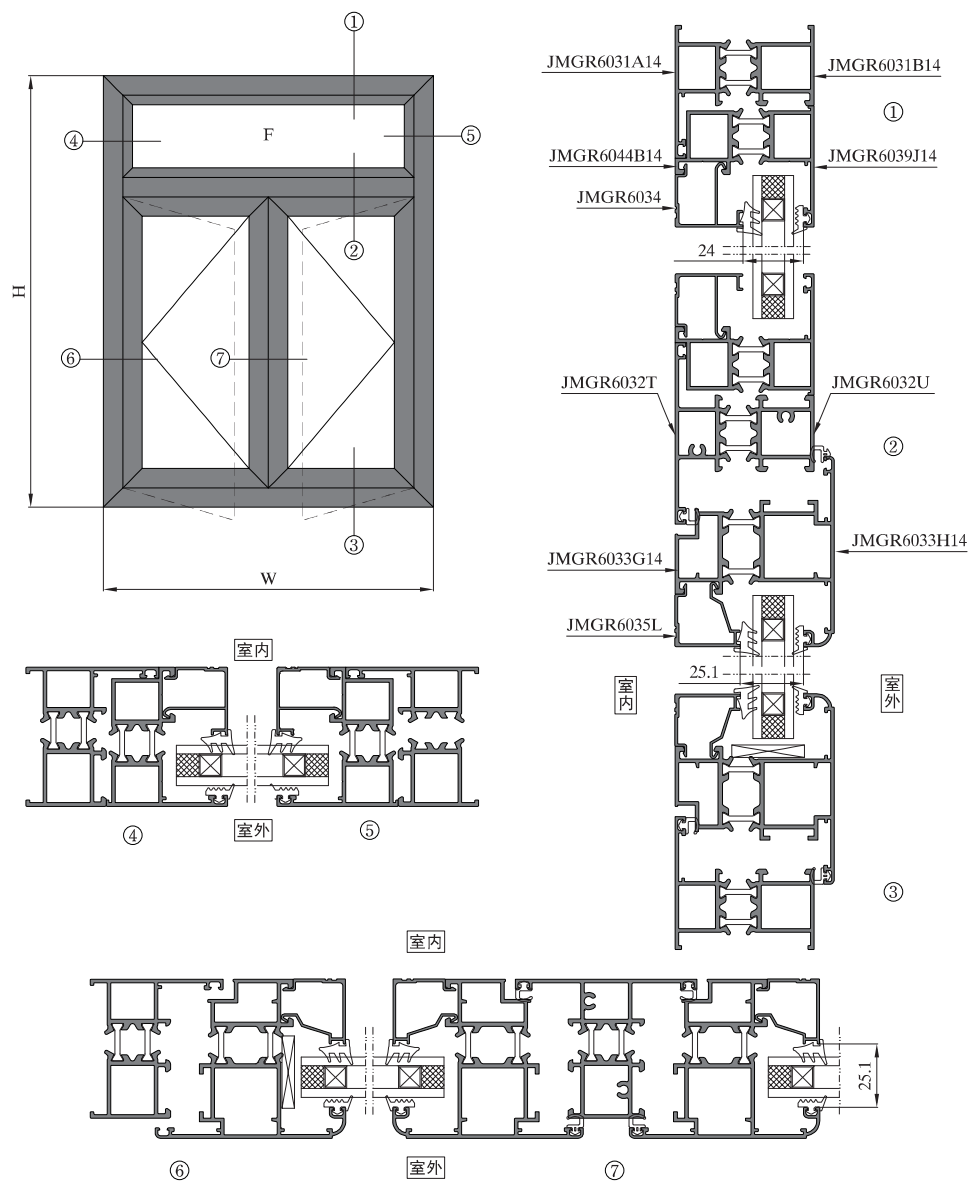

序号 S/N	型号理论重量 JMA Code & KG/M	型材图 Drawing	序号 S/N	型号理论重量 JMA Code & KG/M	型材图 Drawing	序号 S/N	型号理论重量 JMA Code & KG/M	型材图 Drawing
1	窗框 JMGR6031A14 JMGR6031B14 1.209kg/m		10	外开窗扇 JMGR6033HA14 JMGR6033G14 1.518kg/m		19	转角 JMGR6038VB JMGR6038WF 1.340kg/m	
2	窗框 JMGR6031AB14 JMGR6031BB14 1.227kg/m		11	内开窗扇 JMGR6033A14 JMGR6033B14 1.470kg/m		20	拼料 JMGR6038S14 JMGR6038S14 0.976kg/m	
3	门框 JMGR6031AF JMGR6031AG 1.477kg/m		12	转换框 JMGR6039J14 JMGR6044B14 1.104kg/m		21	框压线 内开扇压线 JMGR6034CA 0.262kg/m	
4	中挺 JMGR6032T JMGR6032U 1.453kg/m		13	外开假中挺 JMGR6033M JMGR6033MA 1.374kg/m		22	框压线 内开扇压线 JMGR6034 0.257kg/m	
5	中挺 JMGR6032A14 JMGR6032B14 1.338kg/m		14	内开假中挺 JMGR6039Q JMGR6039R 1.386kg/m		23	框压线 内开扇压线 JMGR6034AE 0.237kg/m	
6	中挺 JMGR6039H14 JMGR6039H14 1.318kg/m		15	转角 GR55F07A GR55F07B 1.690kg/m		24	框压线 内开扇压线 JMGR6035 0.219kg/m	
7	中挺 JMGR6032BR JMGR6032BS 1.701kg/m		16	转角 JMGR6038A JMGR6038C 1.486kg/m		25	框压线 内开扇压线 JMGR6034C 0.247kg/m	
8	加强中挺 JMGR6032B14 JMGR6032C14 1.820kg/m		17	转角 JMGR6038A14 JMGR6038B14 1.525kg/m		26	框压线 内开扇压线 JMGR6034YE 0.220kg/m	
9	外开窗扇 JMGR6033H14 JMGR6033G14 1.580kg/m		18	转角 JMGR5086K JMGR5086L 1.588kg/m		27	框压线 内开扇压线 JMGR6034YB 0.206kg/m	

序号 S/N	型号理论重量 JMA Code & KG/M	型材图 Drawing	序号 S/N	型号理论重量 JMA Code & KG/M	型材图 Drawing	序号 S/N	型号理论重量 JMA Code & KG/M	型材图 Drawing
28	框压线 内开扇压线 JMGR6034ZB 0.200kg/m		37	外开扇压线 JMGR6035ZD 0.197kg/m		46	中挺连接件 JMGR6037A 0.522kg/m	
29	外开扇压线 JMGR6035LA 0.281kg/m		38	角码 JMGR6036 2.278kg/m		47		
30	外开扇压线 JMGR6035L 0.262kg/m		39	角码 JMGR6047A 2.861kg/m		48		
31	外开扇压线 JMGR6035LE 0.230kg/m		40	角码 GRU5506 5.869kg/m		49		
32	外开扇压线 JMGR6035A 0.220kg/m		41	角码 JMGR6059A 4.263kg/m		50		
33	外开扇压线 JMGR6035F 0.253kg/m		42	连杆 JMGR5507A 0.153kg/m		51		
34	外开扇压线 JMGR6035CF 0.228kg/m		43	连杆 JMGR6037N 0.161kg/m		52		
35	外开扇压线 JMGR6035C 0.213kg/m		44	中挺连接件 JMGR5507 1.913kg/m		53		
36	外开扇压线 JMGR6035CD 0.206kg/m		45	中挺连接件 JMGR5507B 0.697kg/m		54		

图中所示型材截面、装配、编号、尺寸及重量仅供参考。如有疑问，请向本公司查询。
Information above just for your reference. Please contact us if you have any questions, Thank you!

图中所示型材截面、装配、编号、尺寸及重量仅供参考。如有疑问，请向本公司查询。
Information above just for your reference. Please contact us if you have any questions, Thank you!

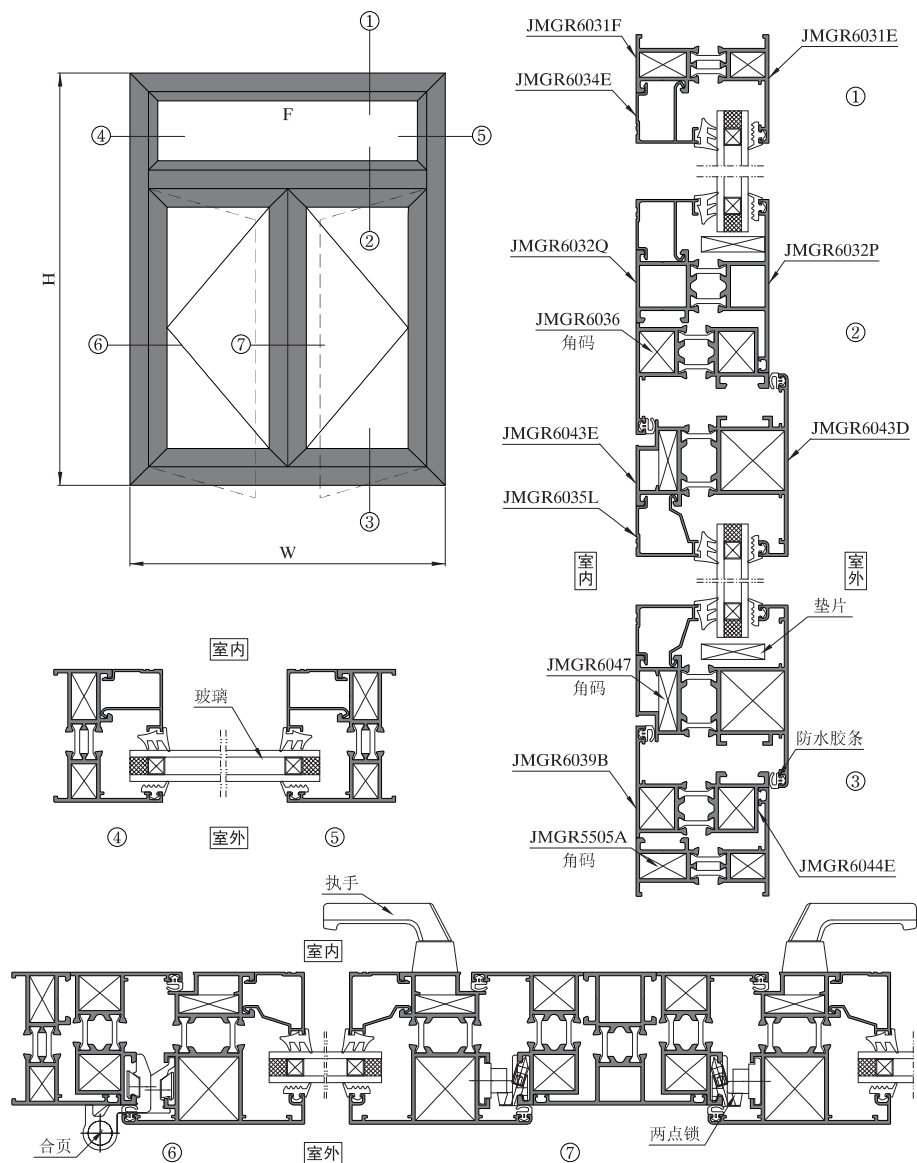

序号 S/N	型号理论重量 JMA Code & KG/M	型材图 Drawing	序号 S/N	型号理论重量 JMA Code & KG/M	型材图 Drawing	序号 S/N	型号理论重量 JMA Code & KG/M	型材图 Drawing
1	框料 JMGR6031F JMGR6031E 1.020kg/m		10	角码 JMGR5505A 3.169kg/m		19		
2	中挺 JMGR6032Q JMGR6032P 1.318kg/m		11	角码 JMGR6047 2.502kg/m		20		
3	外开扇 JMGR6043D JMGR6043E 1.591kg/m		12			21		
4	转换框 JMGR6039B JMGR6044E 1.121kg/m		13			22		
5	转角 JMGR6038H JMGR6038A 1.663kg/m		14			23		
6	框压线 JMGR6034E 0.254kg/m		15			24		
7	扇压线 JMGR6035L 0.262kg/m		16			25		
8	中挺连接件 JMGR6030 0.882kg/m		17			26		
9	角码 JMGR6036 2.278kg/m		18			27		

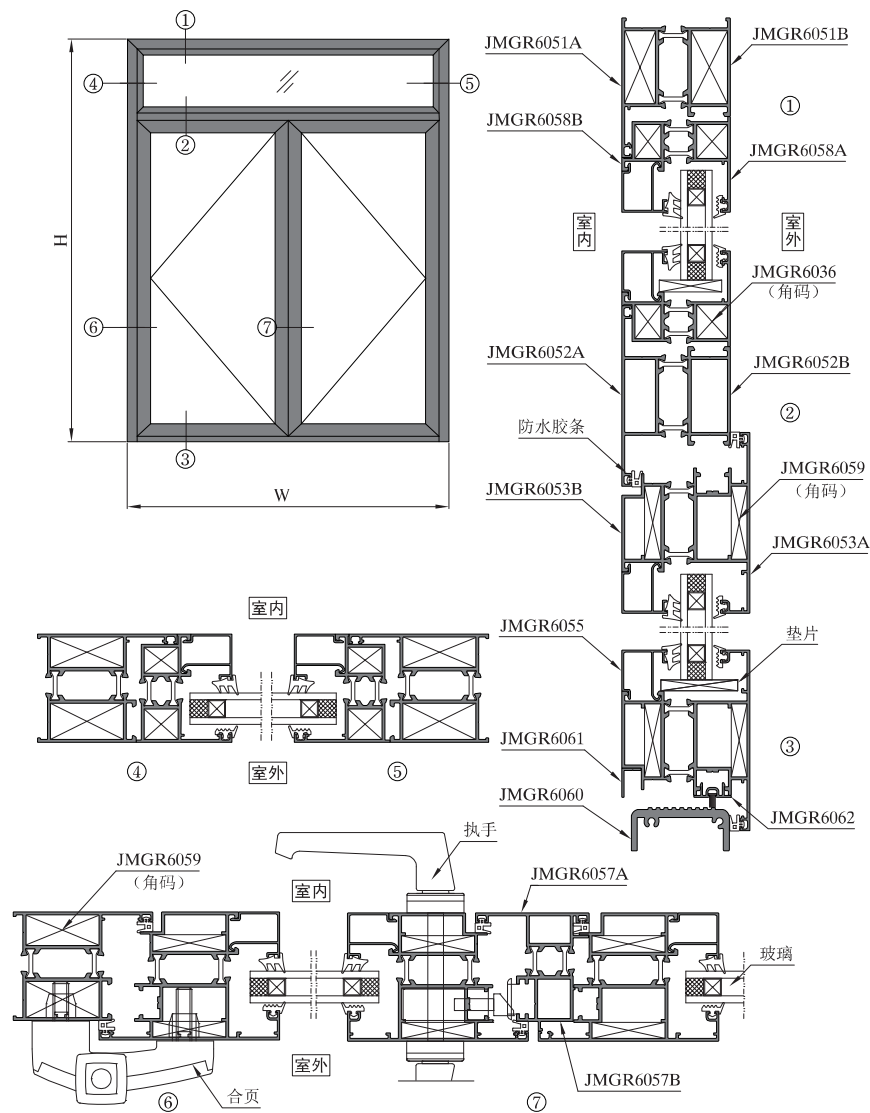
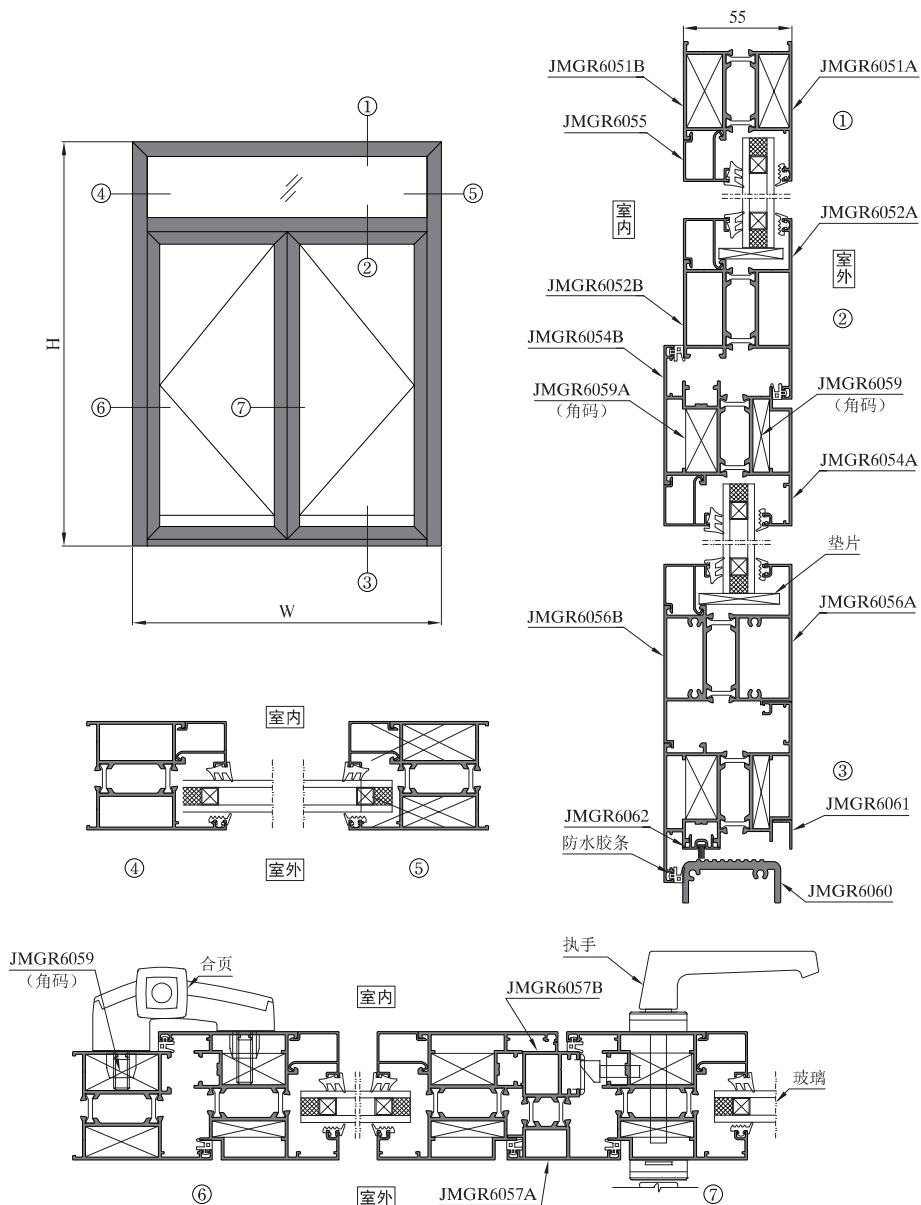

图中所示型材截面、装配、编号、尺寸及重量仅供参考。如有疑问，请向本公司查询。
Information above just for your reference. Please contact us if you have any questions, Thank you!

图中所示型材截面、装配、编号、尺寸及重量仅供参考。如有疑问，请向本公司查询。
Information above just for your reference. Please contact us if you have any questions, Thank you!

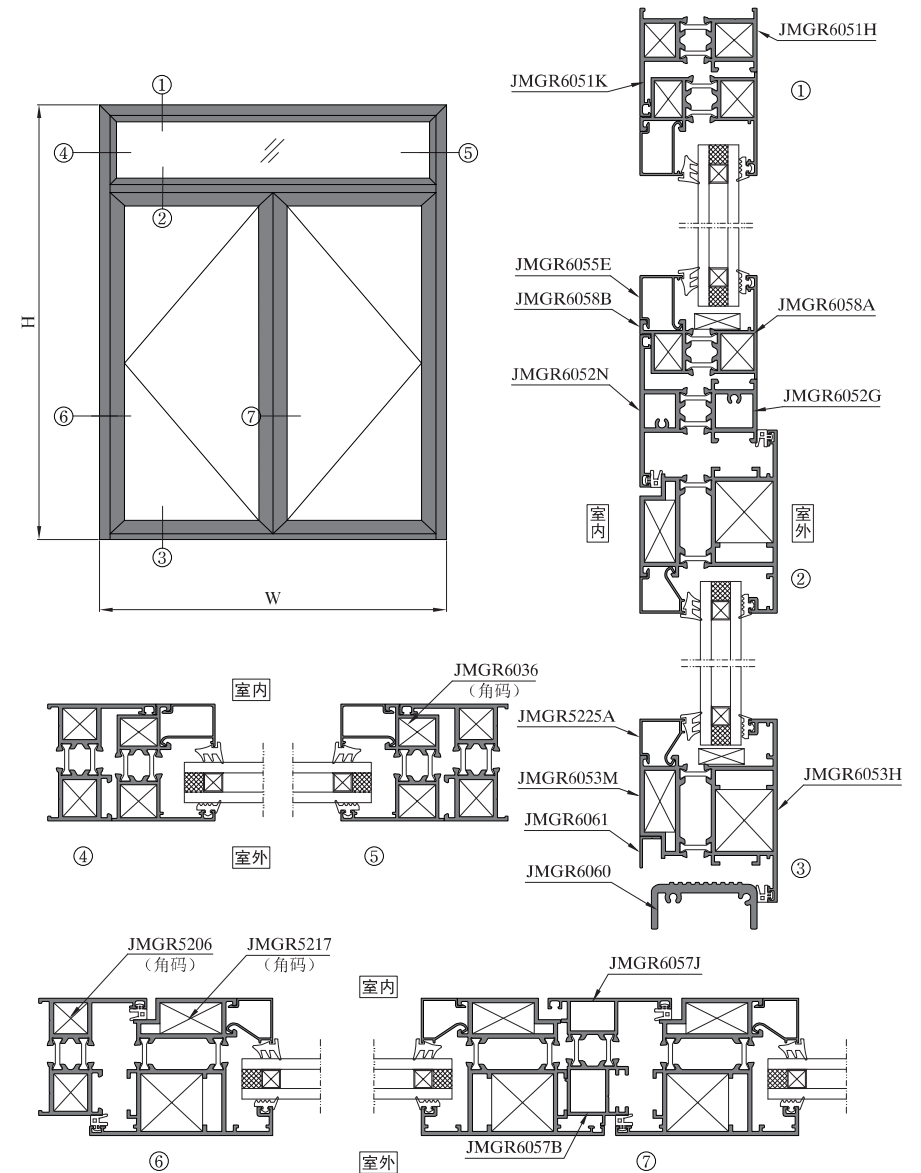
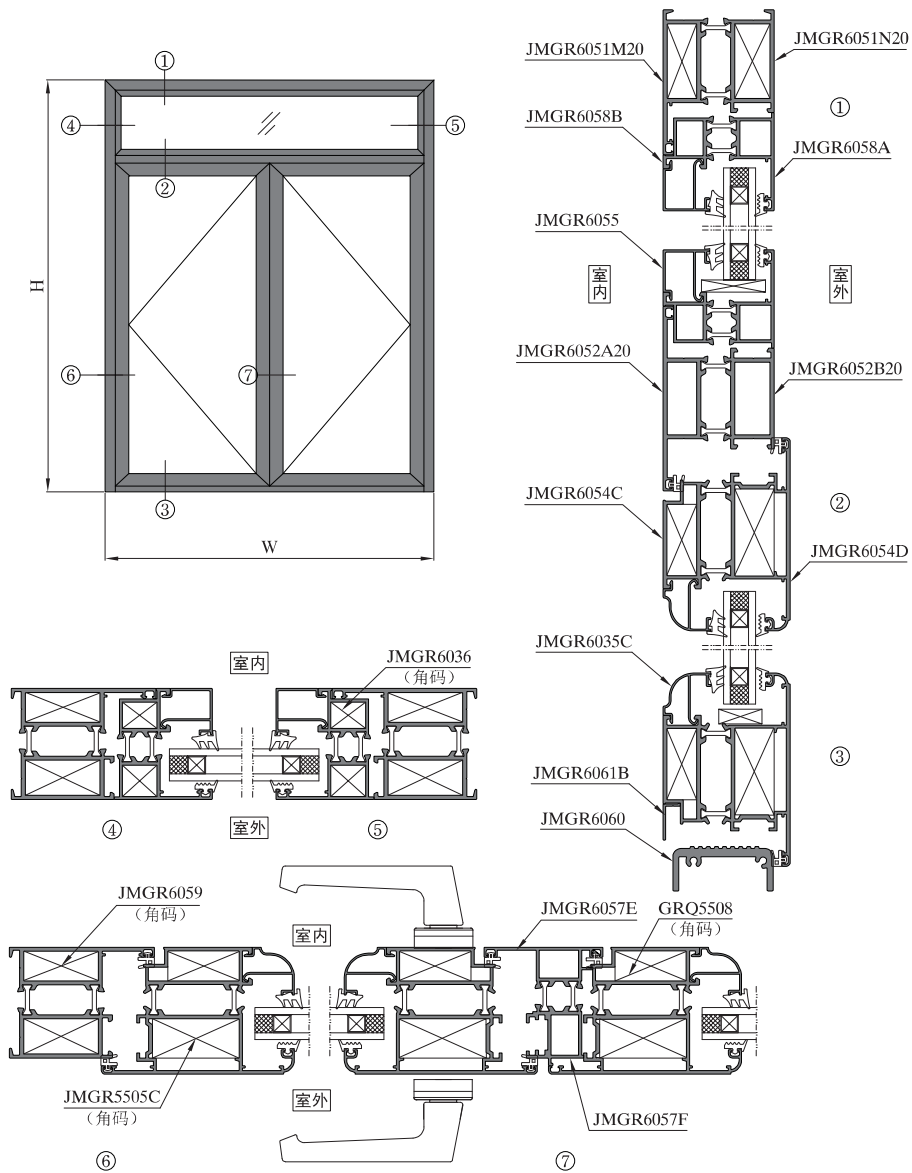

序号 S/N	型号理论重量 JMA Code & KG/M	型材图 Drawing	序号 S/N	型号理论重量 JMA Code & KG/M	型材图 Drawing	序号 S/N	型号理论重量 JMA Code & KG/M	型材图 Drawing
1	框料 JMGR6051A JMGR6051B 1.555kg/m		10	扇中横 JMGR6054G JMGR6054E 2.447kg/m		19	扇中横内开专用 JMGR6056A JMGR6056B 2.013kg/m	
2	框料 JMGR6051A20 JMGR6051B20 1.873kg/m		11	中挺 JMGR6052F JMGR6052G 1.649kg/m		20	扇中横 JMGR6052H JMGR6052J 1.449kg/m	
3	框料 JMGR6051M20 JMGR6051N20 1.893kg/m		12	中挺 JMGR6052B JMGR6052D 2.090kg/m		21	假中挺 JMGR6057A JMGR6057B 1.321kg/m	
4	框料 JMGR6051K JMGR6051H 1.378kg/m		13	外开扇 JMGR6053A JMGR6053B 1.953kg/m		22	假中挺 JMGR6057E JMGR6057F 1.323kg/m	
5	框料 JMGR6051G JMGR6051H 1.381kg/m		14	外开扇 JMGR6053A20 JMGR6053B20 2.376kg/m		23	假中挺 JMGR6057B JMGR6057J 1.309kg/m	
6	中挺 JMGR6052A JMGR6052B 1.696kg/m		15	外开扇 JMGR6053F JMGR6053E 2.366kg/m		24	转换框 JMGR6058A JMGR6058B 1.121kg/m	
7	中挺 JMGR6052A20 JMGR6052B20 2.019kg/m		16	外开扇 JMGR6054D JMGR6054C 2.198kg/m		25	角码 JMGR6059 4.458kg/m	
8	中挺 JMGR6052N JMGR6052G 1.630kg/m		17	内开扇 JMGR6054A JMGR6054B 1.953kg/m		26	角码 JMGR6059A 4.263kg/m	
9	中挺 JMGR6052B JMGR6052C 2.320kg/m		18	外开扇 JMGR6053M JMGR6053H 2.281kg/m		27	角码 JMGR5206 2.351kg/m	

序号 S/N	型号理论重量 JMA Code & KG/M	型材图 Drawing	序号 S/N	型号理论重量 JMA Code & KG/M	型材图 Drawing	序号 S/N	型号理论重量 JMA Code & KG/M	型材图 Drawing
28	角码 JMGR5505C 7.855kg/m		37	外开扇压线 JMGR5225E 0.210kg/m		46	外开扇压线 JMGR6035K 0.224kg/m	
29	角码 GRQ5508 5.341kg/m		38	外开扇压线 JMGR6035A 0.220kg/m		47	外开扇压线 JMGR6035L 0.262kg/m	
30	角码 JMGR5217 4.264kg/m		39	外开扇压线 JMGR6035B 0.202kg/m		48	外开扇压线 JMGR6035LA 0.281kg/m	
31	角码 JMGR6036 2.278kg/m		40	外开扇压线 JMGR6035C 0.213kg/m		49	外开扇压线 JMGR6035W 0.232kg/m	
32	外开扇压线 JMGR5225 0.164kg/m		41	外开扇压线 JMGR6035CA 0.316kg/m		50	外开扇压线 JMGR6035P 0.298kg/m	
33	外开扇压线 JMGR5225B 0.192kg/m		42	外开扇压线 JMGR6035E 0.244kg/m		51	外开扇压线 JMGR6035X 0.203kg/m	
34	外开扇压线 JMGR5225D 0.228kg/m		43	外开扇压线 JMGR6035F 0.253kg/m		52	外开扇压线 JMGR6035Y 0.237kg/m	
35	外开扇压线 JMGR5225A 0.201kg/m		44	外开扇压线 JMGR6035G 0.217kg/m		53	框压线 JMGR6055 0.238kg/m	
36	外开扇压线 JMGR5225C 0.192kg/m		45	外开扇压线 JMGR6035J 0.192kg/m		54	框压线 JMGR6055A 0.231kg/m	

图中所示型材截面、装配、编号、尺寸及重量仅供参考。如有疑问，请向本公司查询。
Information above just for your reference. Please contact us if you have any questions, Thank you!

图中所示型材截面、装配、编号、尺寸及重量仅供参考。如有疑问，请向本公司查询。
Information above just for your reference. Please contact us if you have any questions, Thank you!

序号 S/N	型号理论重量 JMA Code & KG/M	型材图 Drawing	序号 S/N	型号理论重量 JMA Code & KG/M	型材图 Drawing	序号 S/N	型号理论重量 JMA Code & KG/M	型材图 Drawing
55	框压线 JMGR6055B 0.198kg/m	玻璃开口32mm 	64	JMGR6061 0.082kg/m		73		
56	框压线 JMGR6055C 0.261kg/m	玻璃开口19mm 	65	JMGR6061A 0.141kg/m		74		
57	框压线 JMGR6055E 0.214kg/m	玻璃开口30mm 	66	JMGR6061B 0.090kg/m		75		
58	框压线 JMGR6055F 0.239kg/m	玻璃开口22mm 	67	JMGR6062 0.116kg/m		76		
59	框压线 JMGR6055J 0.245kg/m	玻璃开口27mm 	68			77		
60	框压线 JMGR6055K 0.260kg/m	玻璃开口22mm 	69			78		
61	90° 转角 JMGR5086K JMGR5086L 1.588kg/m	专配JMGR6051M/N 	70			79		
62	90° 转角 JMGR6038H JMGR6038A 1.663kg/m		71			80		
63	脚踏板 JMGR6060 1.011kg/m		72			81		

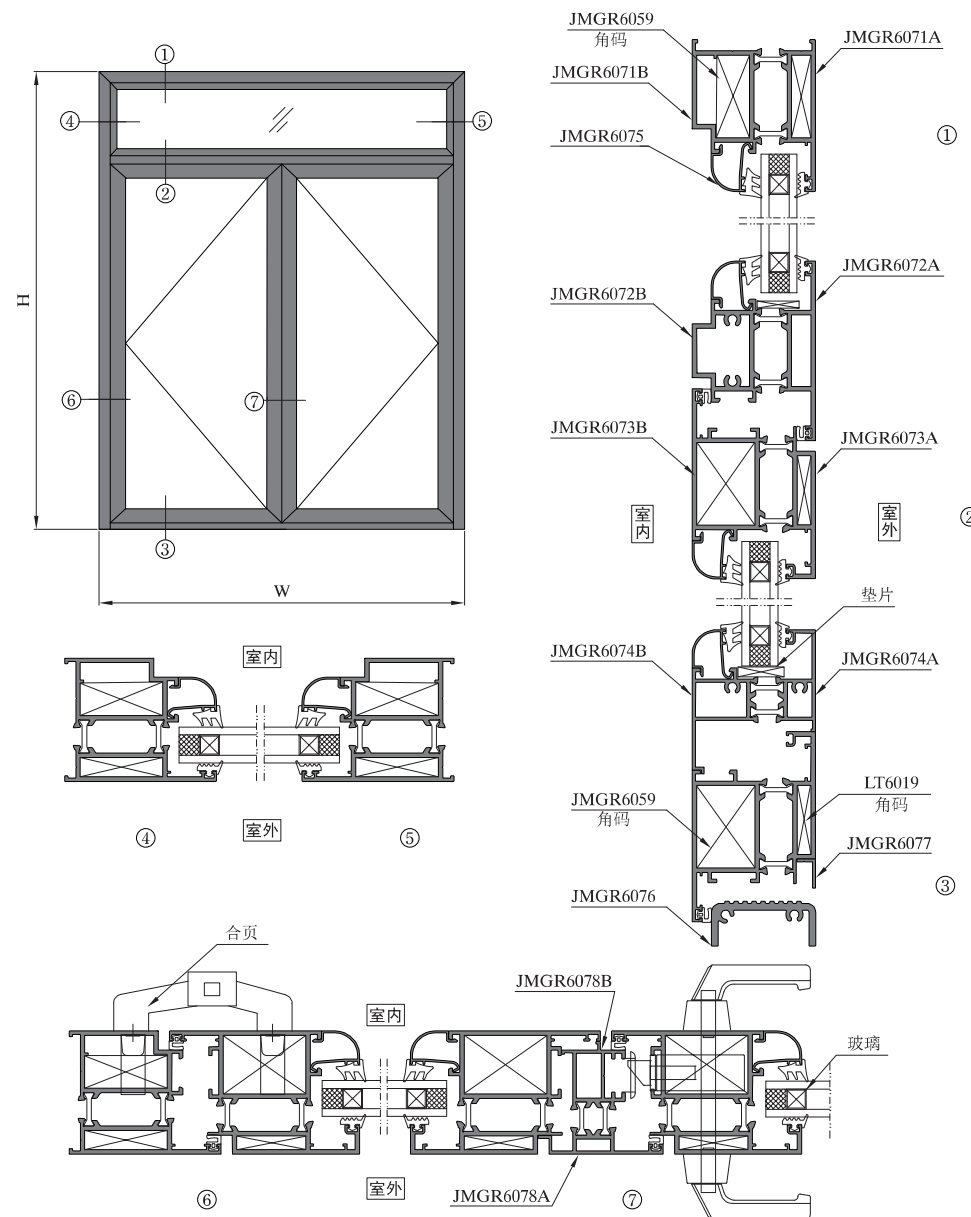

序号 S/N	型号理论重量 JMA Code & KG/M	型材图 Drawing	序号 S/N	型号理论重量 JMA Code & KG/M	型材图 Drawing	序号 S/N	型号理论重量 JMA Code & KG/M	型材图 Drawing
1	框料 JMGR6071A JMGR6071B 1.852kg/m	角码配JMGR6059 压线配JMGR6075 开口27mm 	10	框、扇压线 JMGR6075A 0.179kg/m	玻璃开口25mm 	19		
2	框料 JMGR6071E JMGR6071F 1.670kg/m	角码配JMGR5217 压线配JMGR6075 开口27mm 	11	框、扇压线 JMGR6075C 0.171kg/m	玻璃开口32mm 	20		
3	中挺 JMGR6072A JMGR6072B 1.995kg/m	压线配JMGR6075 开口27mm 	12	框、扇压线 JMGR6075F 0.166kg/m	玻璃开口30.5mm 	21		
4	加强中挺 JMGR6072B JMGR6072C 2.289kg/m	压线配JMGR6075 开口27mm 	13	框、扇压线 JMGR6075G 0.187kg/m	玻璃开口25mm 	22		
5	假中挺 JMGR6078A JMGR6078B 1.147kg/m		14	角码 JMGR6059 4.458kg/m		23		
6	门槛 JMGR6076 0.828kg/m		15	角码 LT6019 5.668kg/m		24		
7	内开扇 JMGR6073A JMGR6073B 2.062kg/m	角码配JMGR6059, LT6019 压线配JMGR6075 开口27mm 	16	角码 JMGR5217 4.264kg/m		25		
8	拼料 JMGR6074A JMGR6074B 1.351kg/m	压线配JMGR6075 开口27mm 	17	JMGR6077 0.070kg/m		26		
9	框、扇压线 JMGR6075 0.160kg/m	玻璃开口27mm 	18			27		

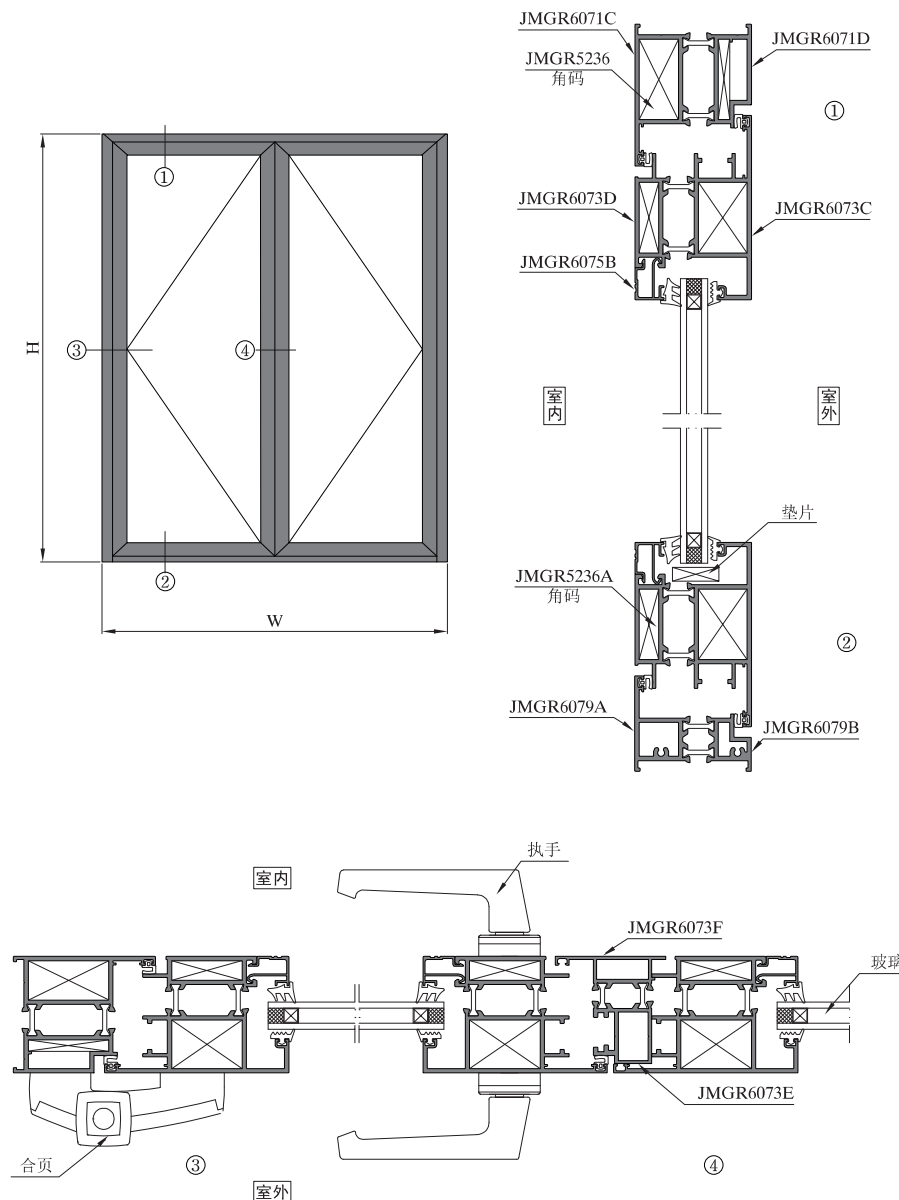

图中所示型材截面、装配、编号、尺寸及重量仅供参考。如有疑问，请向本公司查询。
Information above just for your reference. Please contact us if you have any questions, Thank you!

图中所示型材截面、装配、编号、尺寸及重量仅供参考。如有疑问，请向本公司查询。
Information above just for your reference. Please contact us if you have any questions, Thank you!

序号 S/N	型号理论重量 JMA Code & KG/M	型材图 Drawing	序号 S/N	型号理论重量 JMA Code & KG/M	型材图 Drawing	序号 S/N	型号理论重量 JMA Code & KG/M	型材图 Drawing
1	框料 JMGR6071C JMGR6071D 1.812kg/m		10	框、扇压线 JMGR6075H 0.139kg/m		19		
2	框料 JMGR6079A JMGR6079B 1.394kg/m		11	角码 JMGR5236 7.735kg/m		20		
3	中横 JMGR6073G JMGR6073H 3.383kg/m		12	角码 JMGR5236A 6.706kg/m		21		
4	假中挺 JMGR6073E JMGR6073F 1.261kg/m		13	角码 GRW6118 2.778kg/m		22		
5	外开扇 JMGR6073C JMGR6073D 2.168kg/m		14			23		
6	外开扇 JMGR6073J JMGR6073K 1.814kg/m		15			24		
7	框、扇压线 JMGR6075B 0.187kg/m		16			25		
8	框、扇压线 JMGR6075D 0.152kg/m		17			26		
9	框、扇压线 JMGR6075E 0.148kg/m		18			27		

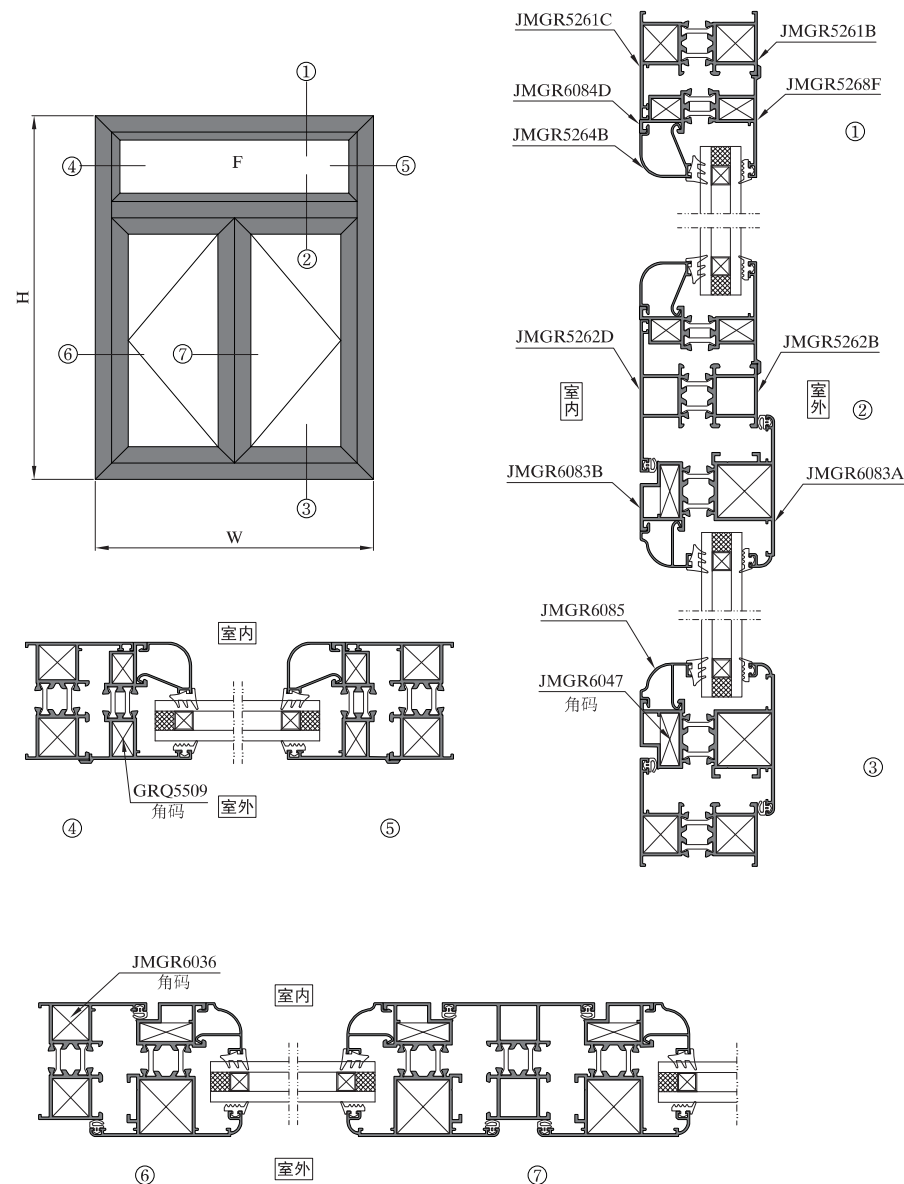

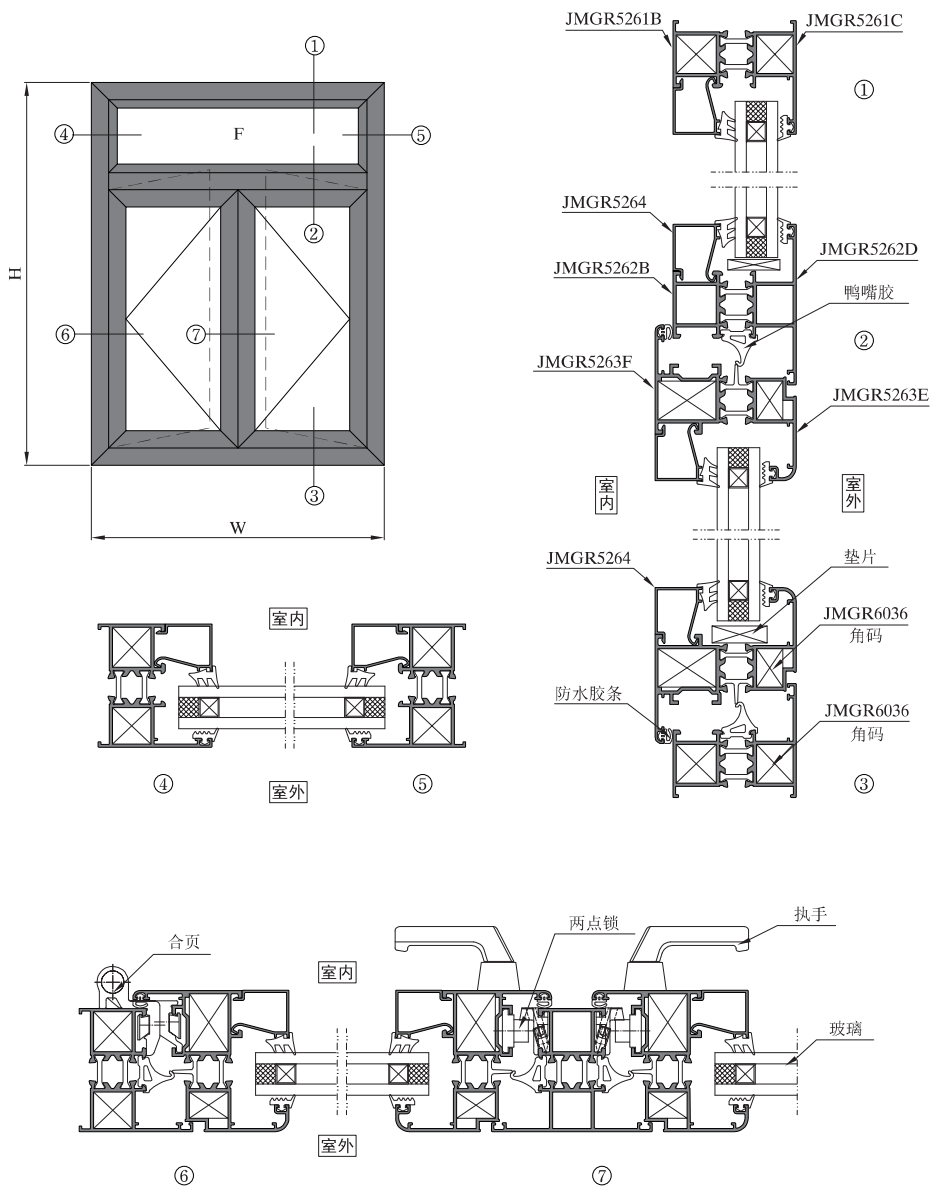

序号 S/N	型号理论重量 JMA Code & KG/M	型材图 Drawing	序号 S/N	型号理论重量 JMA Code & KG/M	型材图 Drawing	序号 S/N	型号理论重量 JMA Code & KG/M	型材图 Drawing
1	框料 JMGR5261B JMGR5261C 1.140kg/m	角码配JMGR6036 JMGR5261C JMGR5261B	10	内开扇 JMGR5263Z JMGR5263F 1.431kg/m	角码配JMGR6036 JMGR5263Z JMGR5263F	19	JMGR5264D 0.191kg/m	玻璃开口34mm
2	外开专用框 JMGR5261B JMGR5261R 1.119kg/m	角码配JMGR6036 JMGR5261R JMGR5261B	11	内开扇 JMGR5263S15 JMGR5263T15 1.798kg/m	角码配GRO5508 JMGR5263S15 JMGR5263T15	20	JMGR6085 0.193kg/m	配JMGR6083A+JMGR6083B 玻璃开口27mm
3	框料 JMGR5261S JMGR5261T 1.509kg/m	角码配GRO5508 JMGR5261S JMGR5261T	12	135° 转角 JMGR1059A JMGR1059B 1.266kg/m	角码配JMGR6036 JMGR1059B JMGR1059A	21	JMGR6085C 0.245kg/m	配JMGR6083A+JMGR6083B 玻璃开口22mm
4	中挺 JMGR5262B JMGR5262D 1.299kg/m	JMGR5262D JMGR5262B	13	转换料 JMGR5268A JMGR5268B 1.027kg/m	角码配JMGR6036 JMGR5268A JMGR5268B	22	JMGR6085E 0.184kg/m	配JMGR6083A+JMGR6083B 玻璃开口36mm
5	加强中挺 JMGR5262B JMGR5262E 1.709kg/m	JMGR5262E JMGR5262B	14	转换料 JMGR5268F JMGR6084D 0.983kg/m	角码配GRO5509 JMGR5268F JMGR6084D	23	JMGR6085H 0.229kg/m	配JMGR6083A+JMGR6083B 玻璃开口22mm
6	加强中挺 JMGR5262F JMGR5262G 2.580kg/m	JMGR5262F JMGR5262G	15	JMGR5264 0.222kg/m	玻璃开口30mm	24	JMGR6085J 0.229kg/m	配JMGR6083A+JMGR6083B 玻璃开口25mm
7	外开扇 JMGR6083A JMGR6083B 1.480kg/m	角码配JMGR6047 JMGR6083A JMGR6083B	16	JMGR5264A 0.213kg/m	玻璃开口30mm	25	JMGR6085L 0.233kg/m	配JMGR6083A+JMGR6083B 玻璃开口26mm
8	外开扇 JMGR5263W15 JMGR5263X15 1.769kg/m	角码配GRO5508 JMGR5263W15 JMGR5263X15	17	JMGR5264B 0.218kg/m	玻璃开口27mm	26	中挺连接件 JMGR5267A 0.768kg/m	
9	内开扇 JMGR5263E JMGR5263F 1.407kg/m	角码配JMGR6036 JMGR5263E JMGR5263F	18	JMGR5264C 0.212kg/m	玻璃开口32mm	27	中挺连接件 JMGR5267D 1.745kg/m	

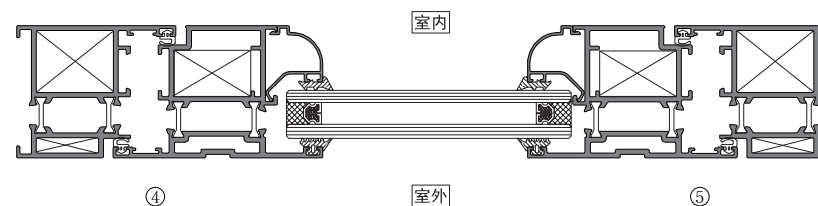
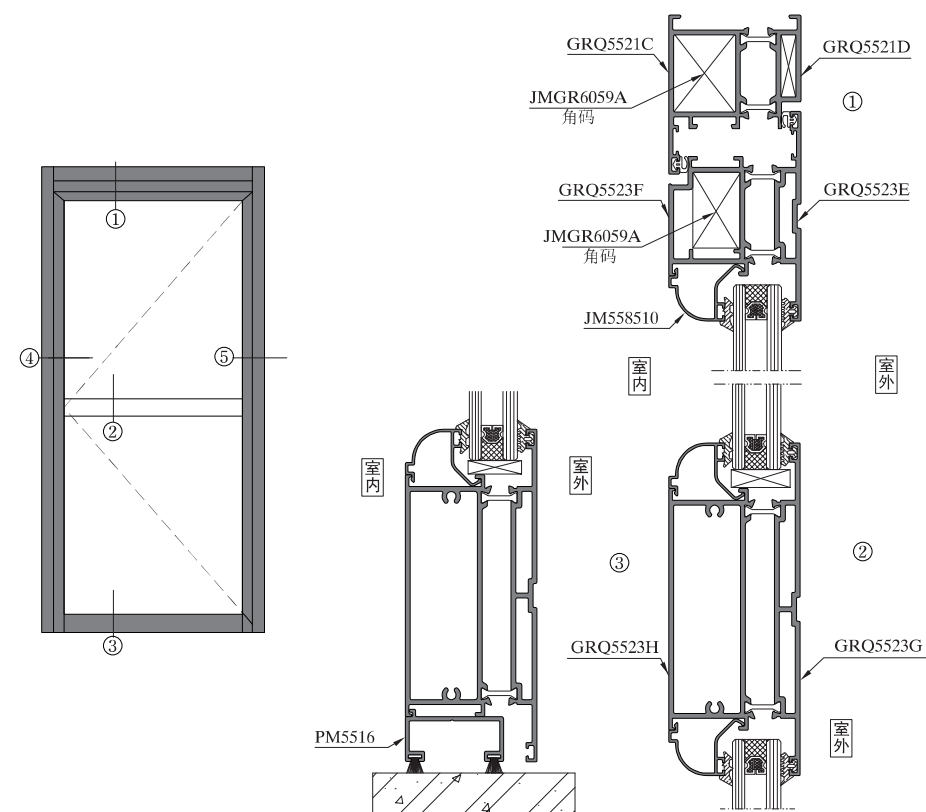
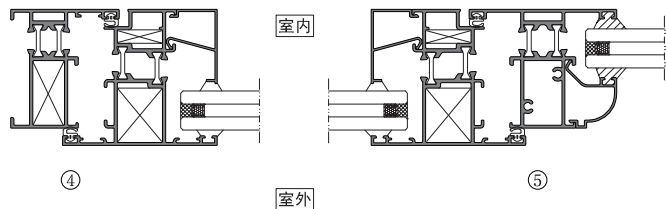
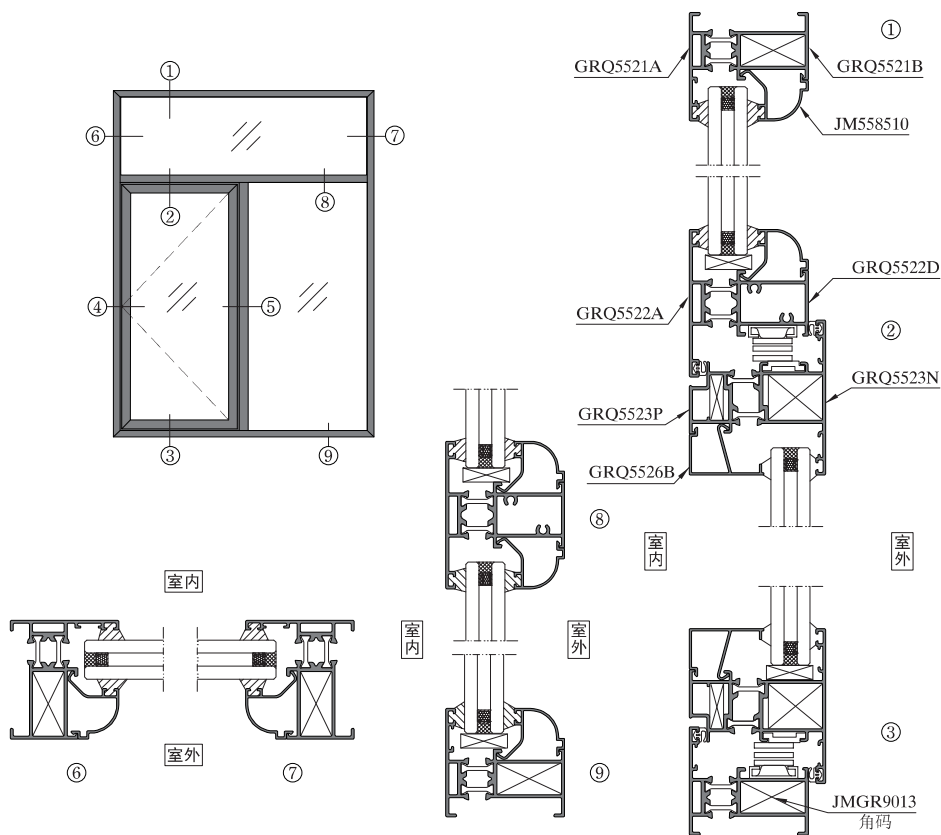

序号 S/N	型号理论重量 JMA Code & KG/M	型材图 Drawing	序号 S/N	型号理论重量 JMA Code & KG/M	型材图 Drawing	序号 S/N	型号理论重量 JMA Code & KG/M	型材图 Drawing
1	框料 GRQ5521A GRQ5521B 1.142kg/m	角码配JMGR9013 54.8 14.8 1.4 31.2 50 1.4 GRQ5521A GRQ5521B	10	压线 JM5585A10 0.242kg/m	玻璃开口27mm 23.3 18.8 1 23.5 31.5	19		
2	框料 GRQ5521C GRQ5521D 1.767kg/m	角码配JMGR6059A GRQ5521C GRQ5521D 66 2 32 14.8 54.8	11	压线 GRQ5526B 0.264kg/m	配GRQ5523N+GRQ5523P 玻璃开口24mm 34.3 18.8 1 23.5 18.45	20		
3	中挺 GRQ5522A GRQ5522B 1.259kg/m	54.8 4.8 68 1.4 30.4 GRQ5522A GRQ5522B	12	连接件 GRQ5527 0.929kg/m	44 29.2 2.5	21		
4	中挺 GRQ5522A GRQ5522D 1.335kg/m	54.8 14.8 68 1.4 30.4 GRQ5522A GRQ5522D	13	扫边 GRQ5527A 0.334kg/m	42.1 1.4 13	22		
5	中横 GRQ5523G GRQ5523H 3.310kg/m	14.8 2 138 100.4 2 54.5 GRQ5523G GRQ5523H	14	PM5516 0.463kg/m	40.7 21.6 1.8	23		
6	假中挺 GRQ5523L GRQ5523M 1.376kg/m	配GRQ5523E+GRQ5523F GRQ5523L GRQ5523M 56 2 14.8 46.8	15	角码 JMGR9013 2.051kg/m	60 60 3 14.4	24		
7	外开扇 GRQ5523N GRQ5523P 1.407kg/m	62.8 14.8 71.3 20.9 1.4 GRQ5523N GRQ5523P	16	角码 JMGR6059A 4.263kg/m	85 3.5 85 31.7	25		
8	外开扇 GRQ5523E GRQ5523F 2.040kg/m	角码配JMGR6059A GRQ5523E GRQ5523F 87 2 32 49.5 54.8	17			26		
9	压线 JM558510 0.227kg/m	玻璃开口27mm 23.3 18.8 1 23.5 31.5	18			27		

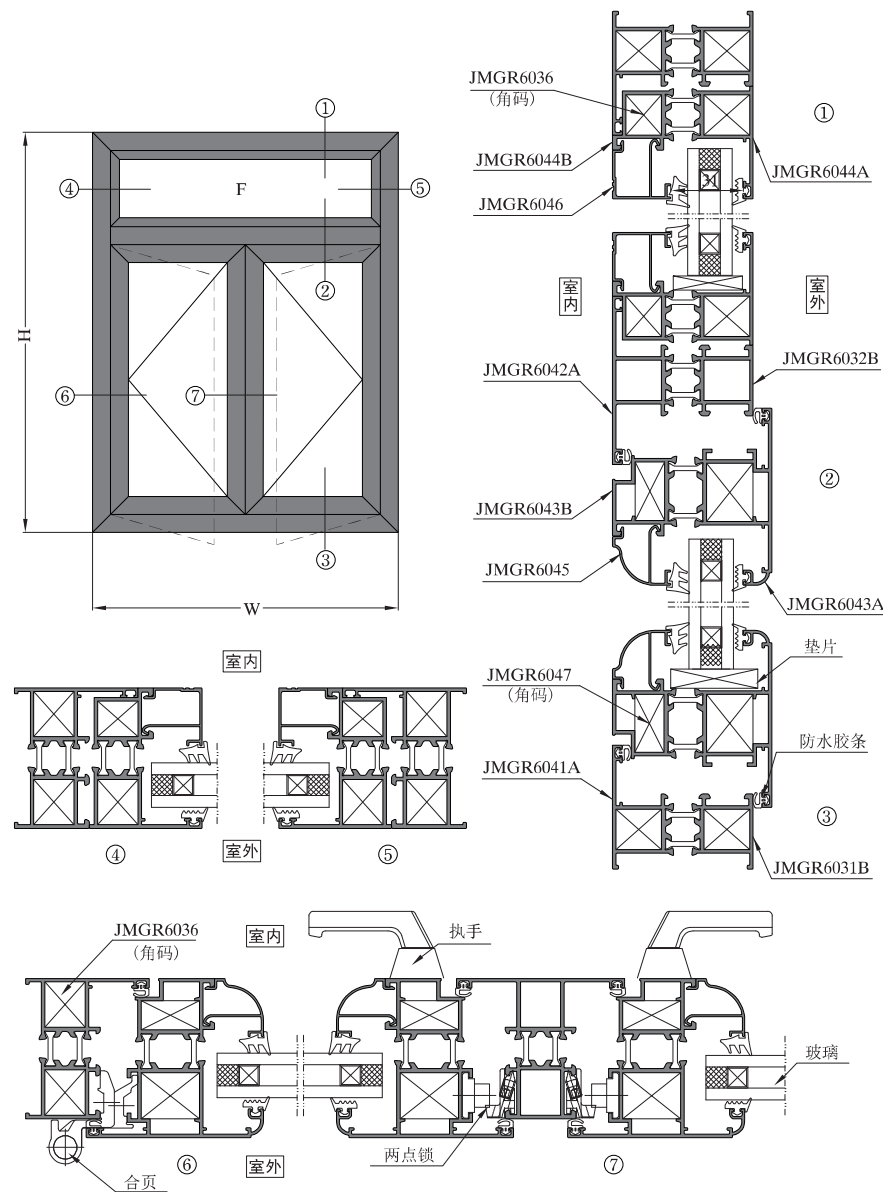

图中所示型材截面、装配、编号、尺寸及重量仅供参考。如有疑问，请向本公司查询。
Information above just for your reference. Please contact us if you have any questions, Thank you!

图中所示型材截面、装配、编号、尺寸及重量仅供参考。如有疑问，请向本公司查询。
Information above just for your reference. Please contact us if you have any questions, Thank you!

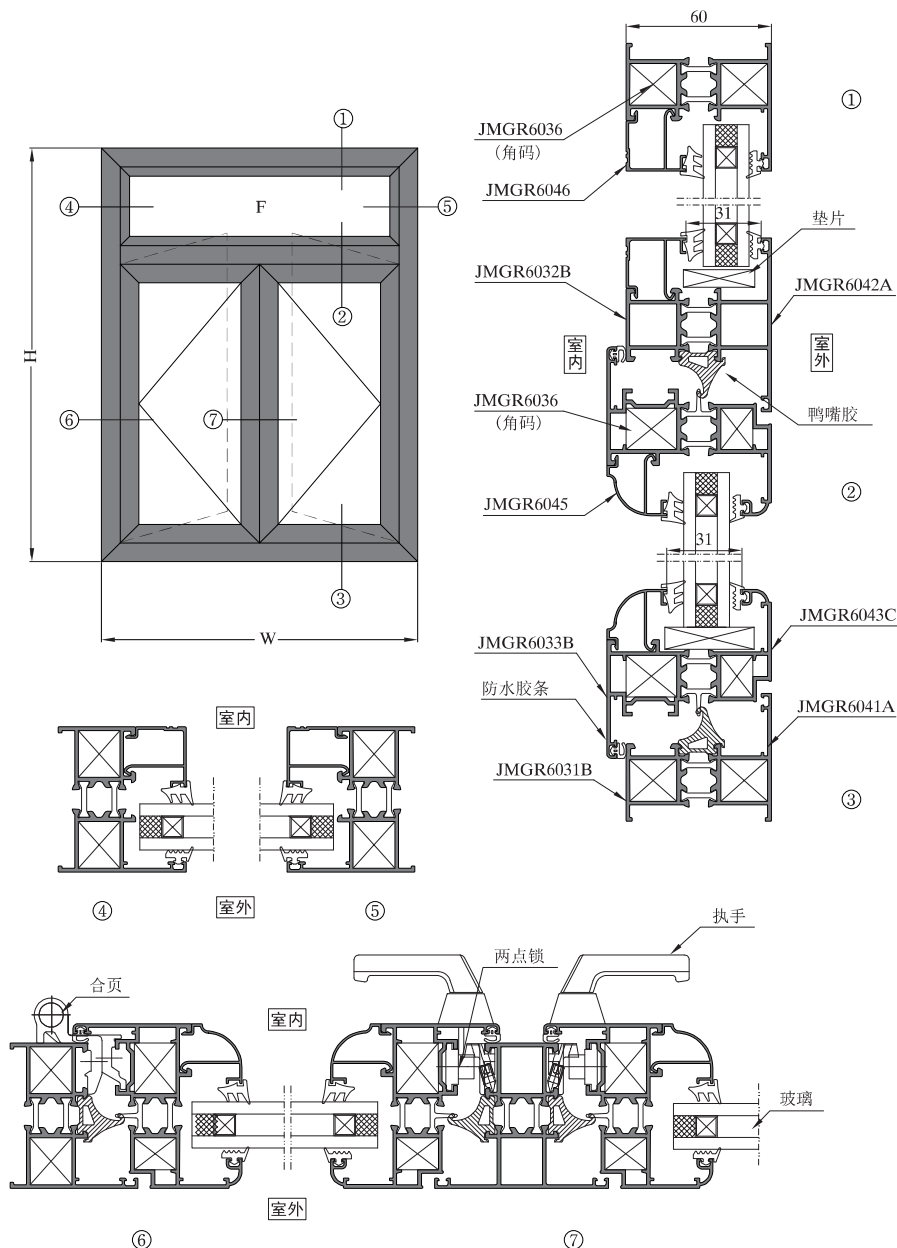

序号 S/N	型号理论重量 JMA Code & KG/M	型材图 Drawing	序号 S/N	型号理论重量 JMA Code & KG/M	型材图 Drawing	序号 S/N	型号理论重量 JMA Code & KG/M	型材图 Drawing
1	窗框 JMGR6041A JMGR6031B 1.274kg/m	角码配JMGR6036 JMGR6041A JMGR6031B 60	10	内开扇 JMGR6043C JMGR6033B 1.538kg/m	角码配JMGR6036 JMGR6033B JMGR6043C 68	19	压线 JMGR6045 0.214kg/m	玻璃开口31mm 24.8 25.6 20.3
2	中挺 JMGR6042A JMGR6032B 1.427kg/m	JMGR6042A JMGR6032B 60	11	内开扇 JMGR6043C JMGR6043N 1.584kg/m	角码JMGR6036 JMGR5257B JMGR6043C JMGR6043N 68	20	压线 JMGR6045J 0.202kg/m	玻璃开口34.8mm 21 25.6 20.3
3	中柱 JMGR6042E JMGR6042F 1.548kg/m	JMGR6042E JMGR6042F 60	12	内开扇 JMGR6043J JMGR6043K 1.665kg/m	角码JMGR5505D MQ18100 JMGR6043J JMGR6043K 68	21	压线 JMGR6046F 0.228kg/m	玻璃开口35.8mm 20 25.6 19.9
4	加强中挺 JMGR6042Q JMGR6032B 1.998kg/m	JMGR6042Q JMGR6032B 100	13	假中挺 JMGR6043G JMGR6043H 1.651kg/m	角码JMGR6036 JMGR6043G JMGR6043H 68	22	压线 JMGR6046G 0.184kg/m	玻璃开口36mm 19.8 25.6 20
5	加强中挺 JMGR6042C JMGR6032B 1.896kg/m	JMGR6042C JMGR6032B 100	14	转换框 JMGR6044A JMGR6044B 1.164kg/m	角码JMGR6036 JMGR6044A JMGR6044B 60	23	压线 JMGR6046H 0.226kg/m	玻璃开口36mm 19.8 26.6 20
6	加强中挺 JMGR6042A JMGR6042D 1.985kg/m	JMGR6042A JMGR6042D 110	15	转换框 JMGR6044F JMGR6044G 1.123kg/m	角码JMGR6036 配JMGR6043L JMGR6043M JMGR6044F JMGR6044G 60	24	压线 JMGR6045B 0.201kg/m	玻璃开口41mm 14.8 26.65 20.1
7	加强中挺 JMGR6042P JMGR6032B 2.028kg/m	JMGR6042P JMGR6032B 115	16	压线 JMGR6046B 0.258kg/m	玻璃开口27mm 28.8 26.65 20.1	25	连接件 JMGR5507 1.913kg/m	18.7 60.5
8	外开扇 JMGR6043A JMGR6043B 1.641kg/m	JMGR6043A JMGR6043B 68	17	压线 JMGR6046 0.251kg/m	玻璃开口31mm 24.8 25.6 20.1	26	连接件 JMGR6050 0.826kg/m	18.7 45.5
9	外开扇 JMGR6043L JMGR6043M 1.703kg/m	角码JMGR5206 配JMGR6044F JMGR6044G JMGR6043M 68	18	压线 JMGR6046A 0.208kg/m	玻璃开口31mm 24.8 25.6 20.1	27	转角 JMGR6038P JMGR6038Q 1.555kg/m	JMGR6038Q JMGR6038P 65

图中所示型材截面、装配、编号、尺寸及重量仅供参考。如有疑问，请向本公司查询。
Information above just for your reference. Please contact us if you have any questions, Thank you!

图中所示型材截面、装配、编号、尺寸及重量仅供参考。如有疑问，请向本公司查询。
Information above just for your reference. Please contact us if you have any questions, Thank you!

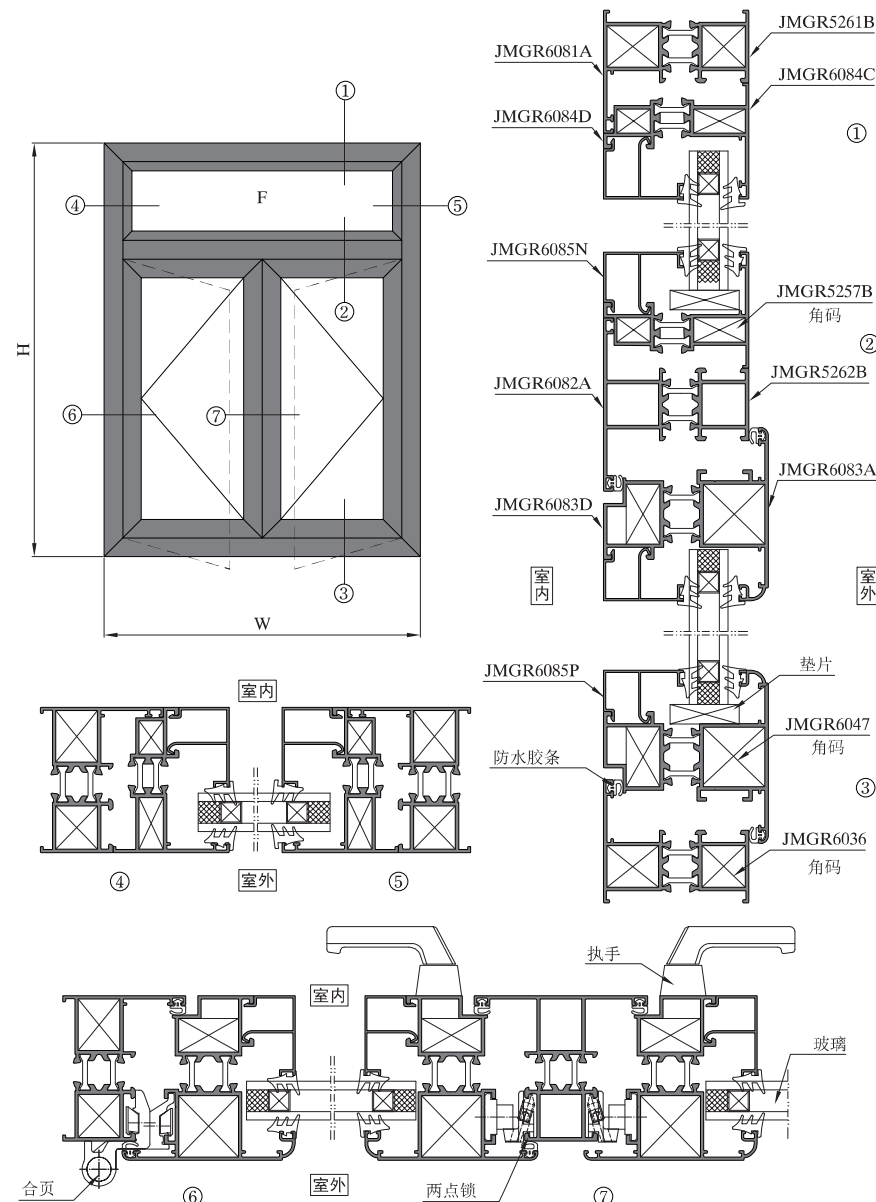
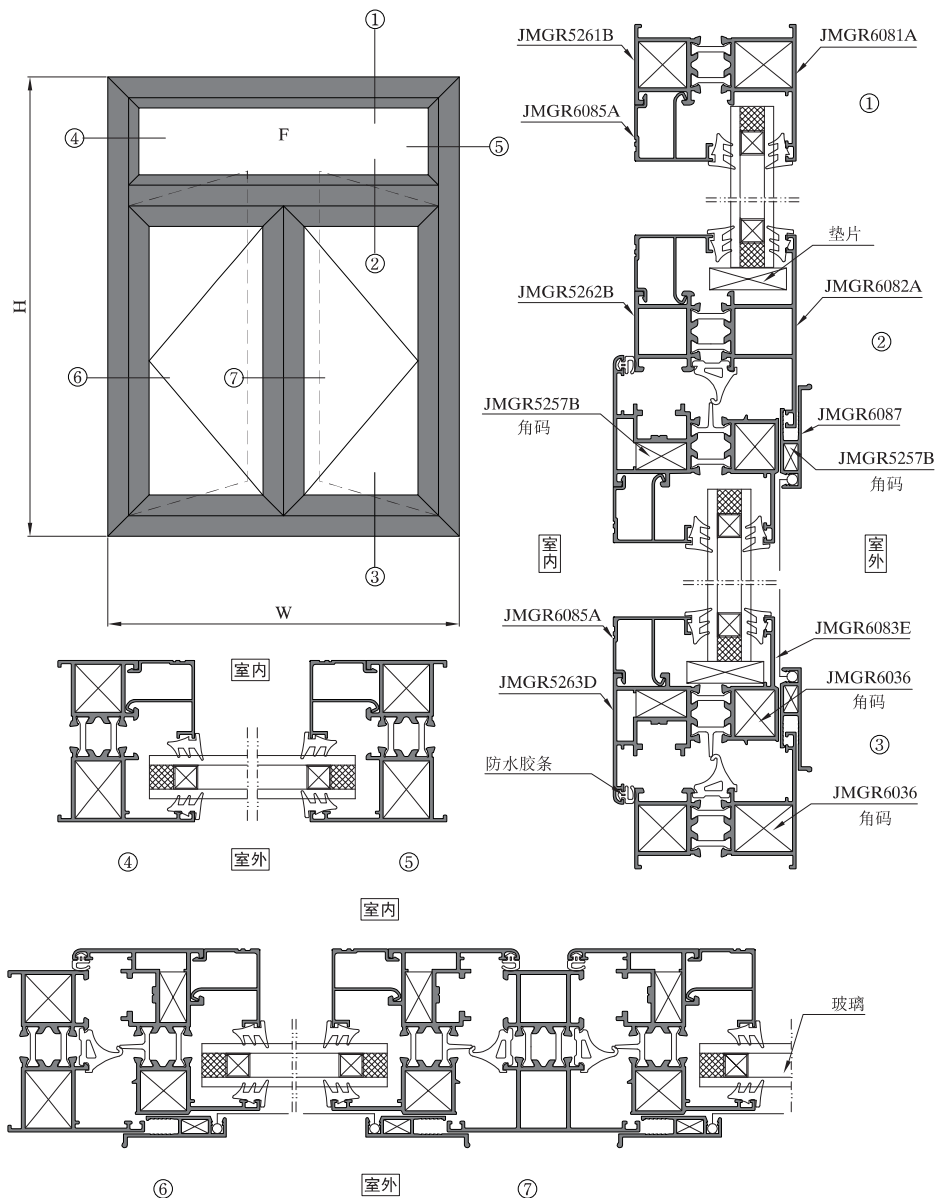

图中所示型材截面、装配、编号、尺寸及重量仅供参考。如有疑问，请向本公司查询。
Information above just for your reference. Please contact us if you have any questions, Thank you!

图中所示型材截面、装配、编号、尺寸及重量仅供参考。如有疑问，请向本公司查询。
Information above just for your reference. Please contact us if you have any questions, Thank you!

序号 S/N	型号理论重量 JMA Code & KG/M	型材图 Drawing	序号 S/N	型号理论重量 JMA Code & KG/M	型材图 Drawing	序号 S/N	型号理论重量 JMA Code & KG/M	型材图 Drawing
1	框料 JMGR6081A JMGR5261B 1.182kg/m		10	外开压线 JMGR6085H 0.229kg/m		19	压线 JMGR6085G 0.249kg/m	
2	中挺 JMGR6082A JMGR5262B 1.339kg/m		11	外开压线 JMGR6085J 0.229kg/m		20	压线 JMGR6085F 0.257kg/m	
3	加强中挺 JMGR6082C JMGR5262B 1.514kg/m		12	外开压线 JMGR6085L 0.233kg/m		21	压线 JMGR6085K 0.256kg/m	
4	外开扇 JMGR6083A JMGR6083D 1.513kg/m		13	外开压线 JMGR6085 0.193kg/m		22	压线 JMGR6085W 0.233kg/m	
5	内开扇 JMGR5263D JMGR6083E 1.395kg/m		14	收边压线 JMGR6085Z 0.189kg/m		23	收边压线 JMGR6085WA 0.193kg/m	
6	内开扇 JMGR6083F JMGR5263F 1.511kg/m		15	外开压线 JMGR6085E 0.184kg/m		24	压线 JMGR6085R 0.215kg/m	
7	转换框 JMGR6084D JMGR6084C 0.995kg/m		16	压线 JMGR6085N 0.271kg/m		25	压线 JMGR6085D 0.204kg/m	
8	外开压线 JMGR6085P 0.238kg/m		17	压线 JMGR6085A 0.268kg/m		26	压线卡口 JMGR6085AA 0.168kg/m	
9	压线 JMGR6085C 0.245kg/m		18	压线 JMGR6085B 0.246kg/m		27	纱窗 JMGR6087 0.279kg/m	

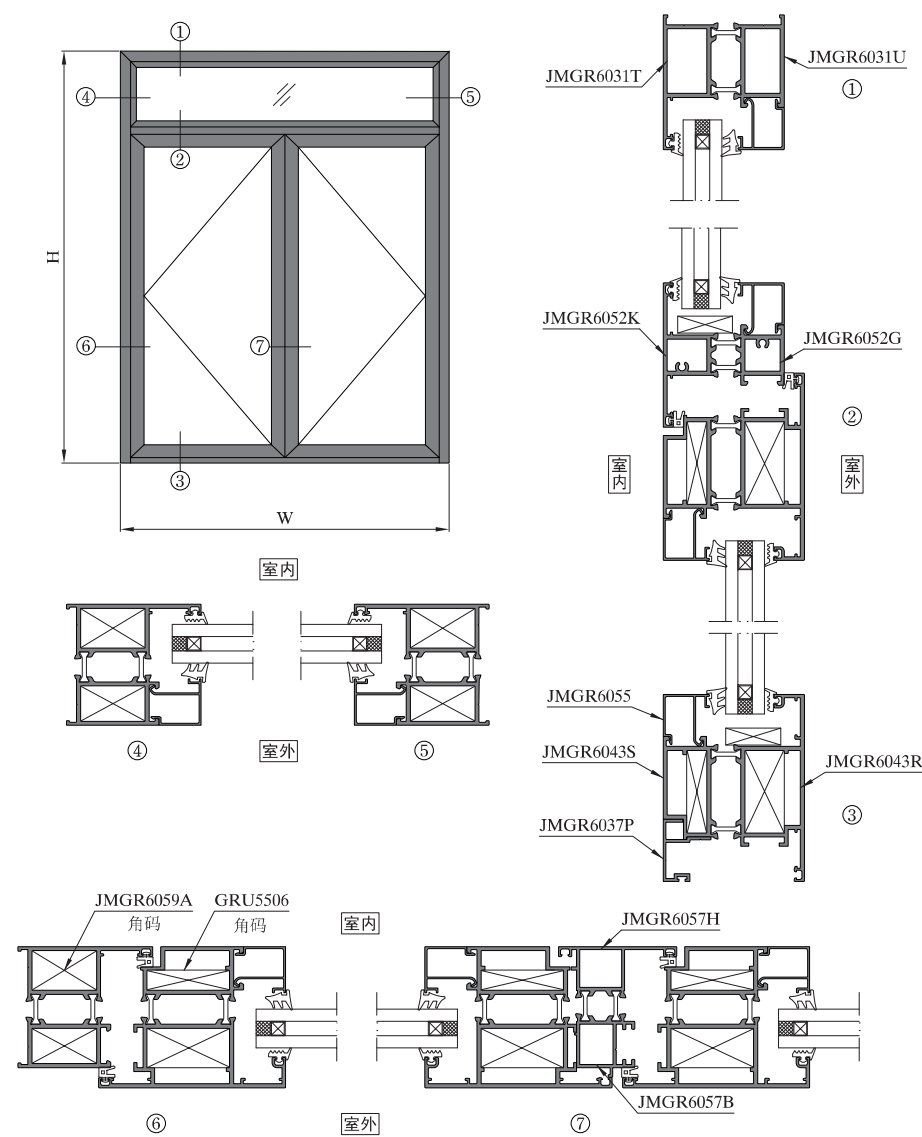

图中所示型材截面、装配、编号、尺寸及重量仅供参考。如有疑问，请向本公司查询。
Information above just for your reference. Please contact us if you have any questions, Thank you!

图中所示型材截面、装配、编号、尺寸及重量仅供参考。如有疑问，请向本公司查询。
Information above just for your reference. Please contact us if you have any questions, Thank you!

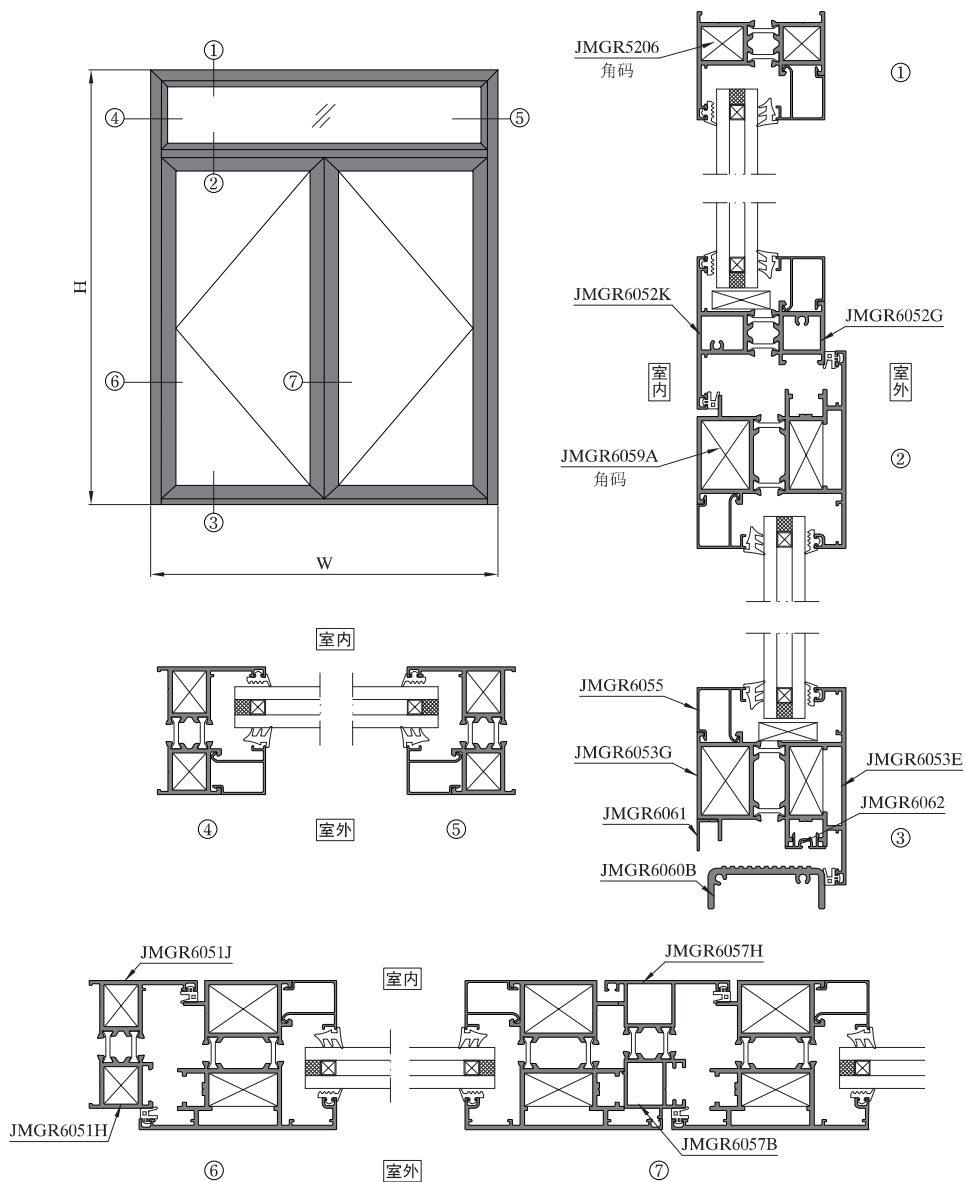

序号 S/N	型号理论重量 JMA Code & KG/M	型材图 Drawing	序号 S/N	型号理论重量 JMA Code & KG/M	型材图 Drawing	序号 S/N	型号理论重量 JMA Code & KG/M	型材图 Drawing
1	门框 JMGR6031T JMGR6031U 1.820kg/m	角码JMGR6059A JMGR6031T JMGR6031U 66.8 2 32 14.8 60	10	压线 JMGR6055B 0.198kg/m	玻璃开口37mm 18 25.6 19.8	19	扫边 JMGR6062 0.116kg/m	7.46 19
2	门框 JMGR6051J JMGR6051H 1.440kg/m	角码JMGR5206 JMGR6051J JMGR6051H 50.8 2 16 14.8 60	11	压线 JMGR6055C 0.261kg/m	玻璃开口24mm 31 25.6 19.9	20	JMGR5206 2.351kg/m	15.5 60
3	门中挺 JMGR6052K JMGR6052G 1.707kg/m	JMGR6052K JMGR6052G 71.6 2 14.8 60	12	压线 JMGR6055E 0.214kg/m	玻璃开口35mm 20 25.6 19.8	21	GRU5506 5.869kg/m	84.3 84.3 40.5
4	门中横 JMGR6052M JMGR6052J 1.490kg/m	JMGR6052M JMGR6052J 71.6 1.4 14.8 70	13	压线 JMGR6055F 0.239kg/m	玻璃开口27mm 28 25.6 19.8	22	JMGR6059A 4.263kg/m	85 85 31.7
5	门扇 JMGR6043S JMGR6043R 2.435kg/m	角码GRU5506 JMGR6043R JMGR6043S 92.7 40.9 14.8 70	14	压线 JMGR6055J 0.245kg/m	玻璃开口32mm 23 25.6 19.8	23		
6	门扇 JMGR6053E JMGR6053G 2.425kg/m	JMGR6053E JMGR6053G 92.7 32.1 14.8 70	15	压线 JMGR6055K 0.260kg/m	玻璃开口27mm 28 25.6 19.8	24		
7	假中挺 JMGR6057B JMGR6057H 1.355kg/m	JMGR6057H JMGR6057B 58.6 14.8 1.5 64.8	16	扫边 JMGR6037P 0.333kg/m	23.7 30.8 1.4	25		
8	压线 JMGR6055 0.238kg/m	玻璃开口32mm 23 25.6 19.8	17	门槛 JMGR6060B 0.838kg/m	20 54.8	26		
9	压线 JMGR6055A 0.231kg/m	玻璃开口31mm 24 25.6 19.8	18	JMGR6061 0.082kg/m	14.8 9.8 1.2	27		

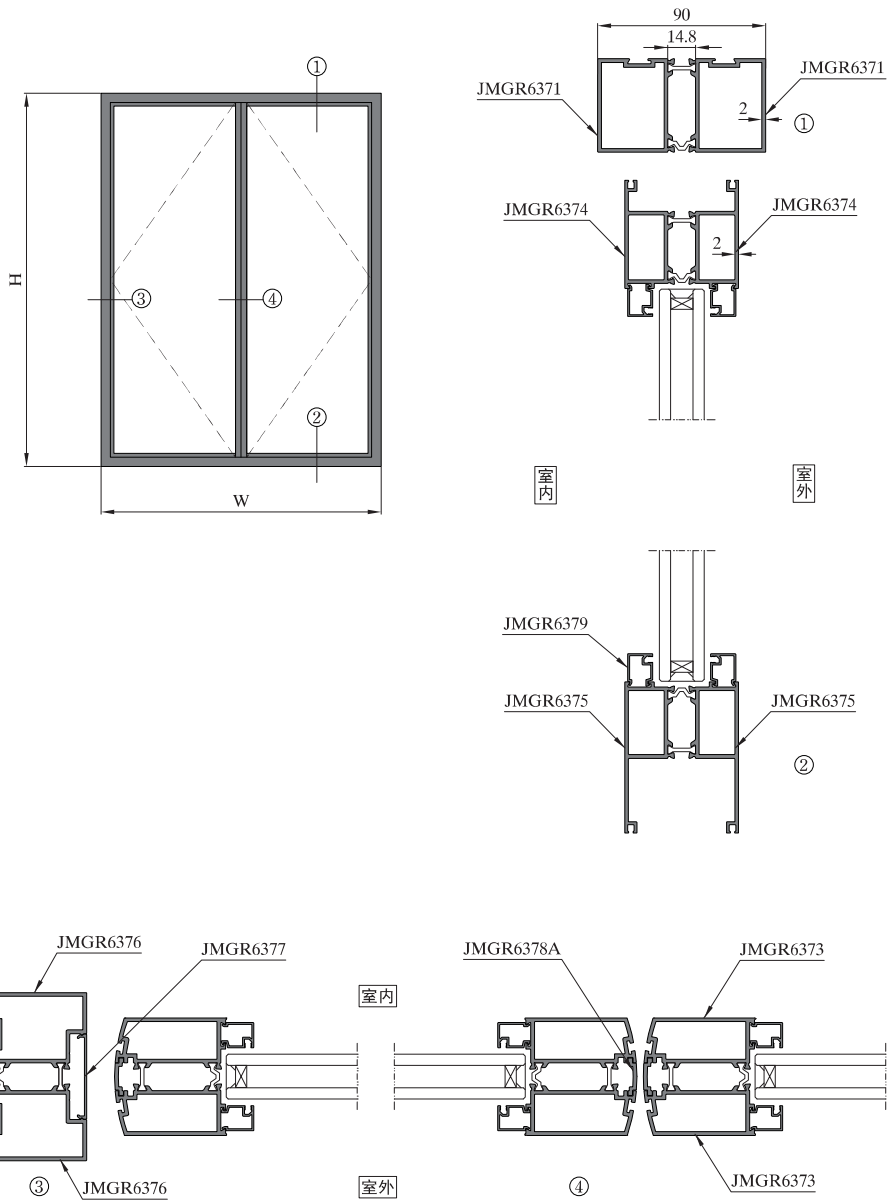

序号 S/N	型号理论重量 JMA Code & KG/M	型材图 Drawing	序号 S/N	型号理论重量 JMA Code & KG/M	型材图 Drawing	序号 S/N	型号理论重量 JMA Code & KG/M	型材图 Drawing
1	边框 JMGR6371 2.300kg/m		10	附件 JMGR6378 0.071kg/m		19		
2	边框 JMGR6372 2.372kg/m		11	JMGR6378A 0.140kg/m		20		
3	边框 JMGR6372A 2.722kg/m		12	压线 JMGR6379 0.166kg/m		21		
4	边框 JMGR6376 2.303kg/m		13	压线 JMGR6379A 0.184kg/m		22		
5	边框 JMGR6376A 2.655kg/m		14	压线 JMGR6379B 0.184kg/m		23		
6	边企 JMGR6373 2.212kg/m		15	压线 JMGR6379C 0.180kg/m		24		
7	上方 JMGR6374 1.948kg/m		16	压线 JMGR6379D 0.174kg/m		25		
8	下方 JMGR6375 2.214kg/m		17	压线 JMGR6379E 0.193kg/m		26		
9	封盖 JMGR6377 0.188kg/m		18			27		

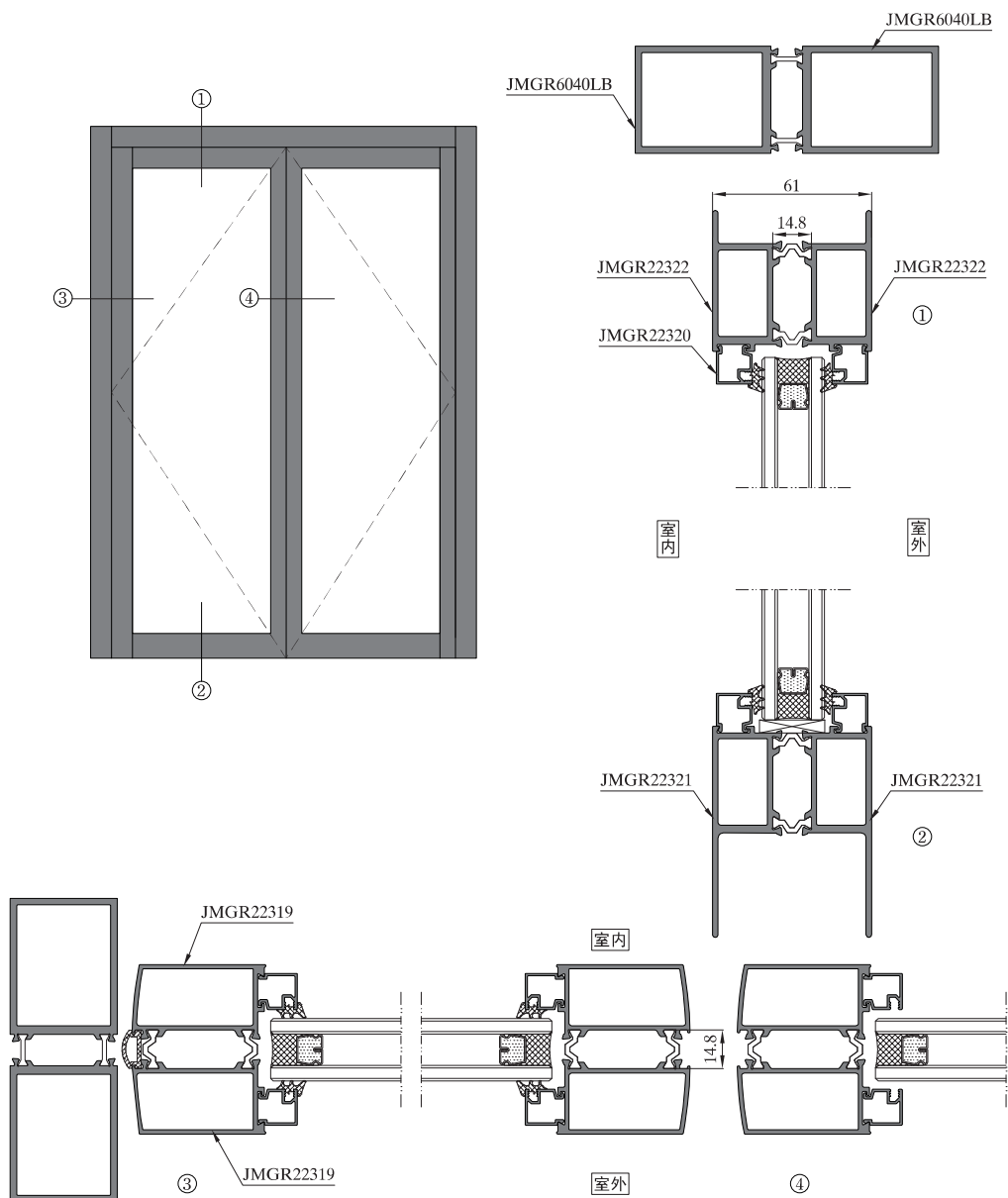

序号 S/N	型号理论重量 JMA Code & KG/M	型材图 Drawing	序号 S/N	型号理论重量 JMA Code & KG/M	型材图 Drawing	序号 S/N	型号理论重量 JMA Code & KG/M	型材图 Drawing
1	扇料 JMGR22319 JMGR22319 1.691kg/m		10			19		
2	扇料 JMGR22321 JMGR22321 2.320kg/m		11			20		
3	扇料 JMGR22322 JMGR22322 2.024kg/m		12			21		
4	扇压线 JMGR22320 0.146kg/m		13			22		
5	JMGR22323 0.072kg/m		14			23		
6	JMGR6040LB JMGR6040LB 4.285kg/m		15			24		
7			16			25		
8			17			26		
9			18			27		

图中所示型材截面、装配、编号、尺寸及重量仅供参考。如有疑问，请向本公司查询。
 Information above just for your reference. Please contact us if you have any questions, Thank you!

图中所示型材截面、装配、编号、尺寸及重量仅供参考。如有疑问，请向本公司查询。
 Information above just for your reference. Please contact us if you have any questions, Thank you!

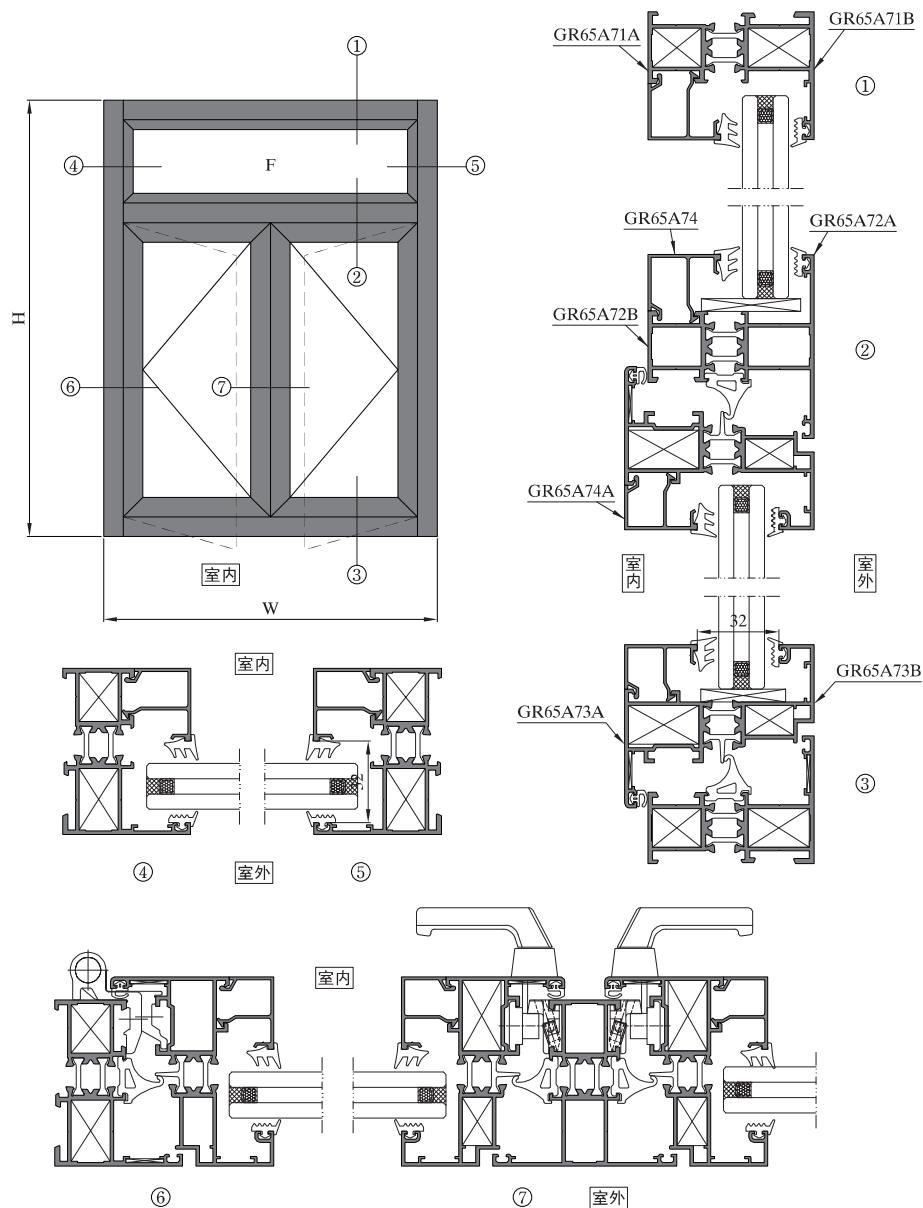

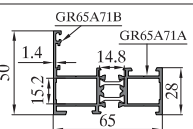
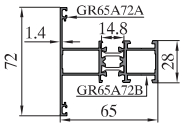
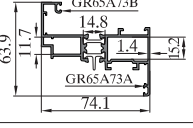
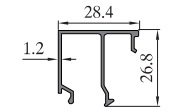
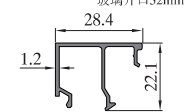
序号 S/N	型号理论重量 JMA Code & KG/M	型材图 Drawing	序号 S/N	型号理论重量 JMA Code & KG/M	型材图 Drawing	序号 S/N	型号理论重量 JMA Code & KG/M	型材图 Drawing
1	GR65A71A GR65A71B 1.350kg/m		10			19		
2	GR65A72A GR65A72B 1.442kg/m		11			20		
3	GR65A73A GR65A73B 1.480kg/m		12			21		
4	框压线 GR65A74 0.310kg/m		13			22		
5	扇压线 GR65A74A 0.280kg/m		14			23		
6			15			24		
7			16			25		
8			17			26		
9			18			27		

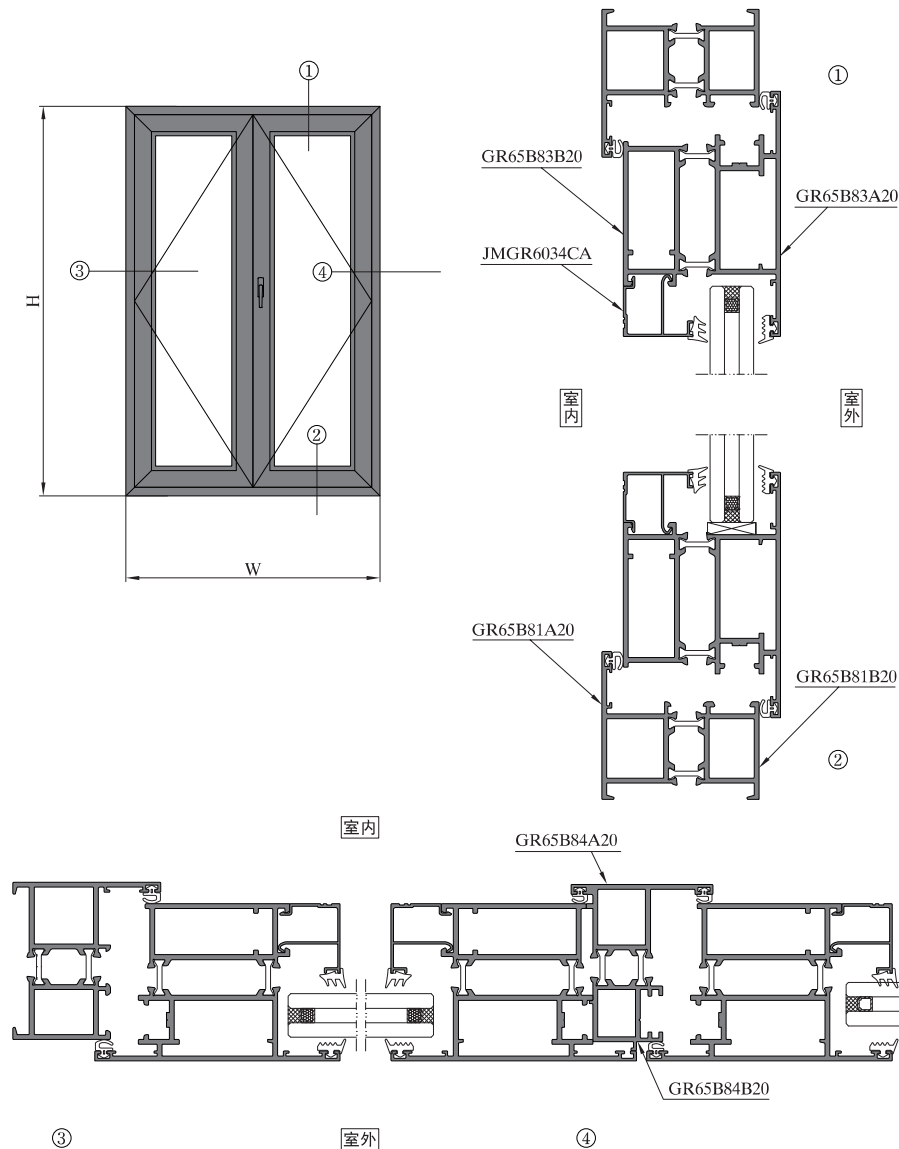
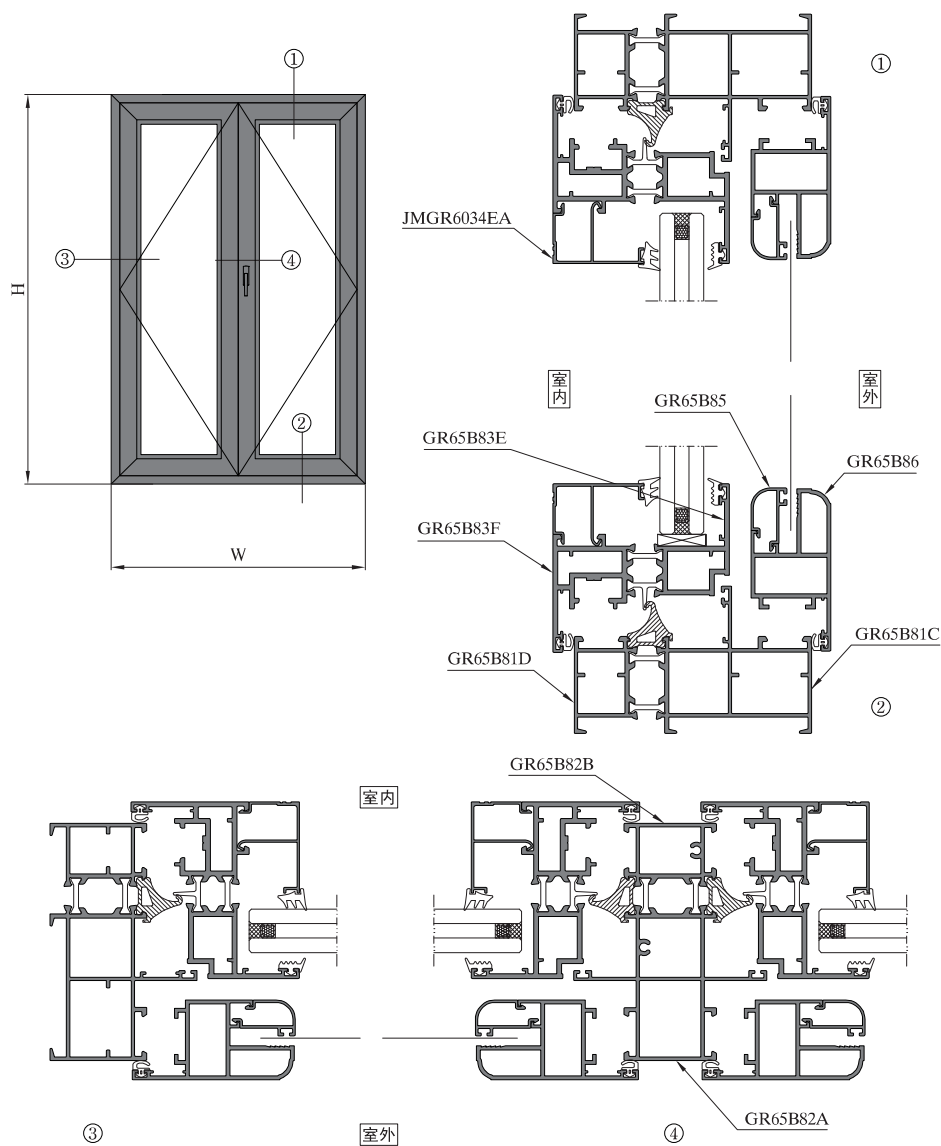

序号 S/N	型号理论重量 JMA Code & KG/M	型材图 Drawing	序号 S/N	型号理论重量 JMA Code & KG/M	型材图 Drawing	序号 S/N	型号理论重量 JMA Code & KG/M	型材图 Drawing
1	框料 GR65B81A20 GR65B81B20 1.790kg/m		10	90° 转角 GR65B87C GR65B87D 2.076kg/m		19		
2	框料 GR65B81C GR65B81D 1.993kg/m		11	外开扇压线 JMGR6034CA 0.262kg/m		20		
3	中挺 GR65B82A GR65B82B 2.179kg/m		12	外开扇压线 JMGR6034EA 0.288kg/m		21		
4	中挺 GR65B82C GR65B82D 1.832kg/m		13	纱窗扇 GR65B86 0.978kg/m		22		
5	假中挺 GR65B84A20 GR65B84B20 1.644kg/m		14	压线 GR65B85 0.207kg/m		23		
6	外开扇 GR65B83A20 GR65B83B20 2.581kg/m		15	角码 B-5017A30 3.021kg/m		24		
7	外开扇 GR65B83C GR65B83D 1.976kg/m		16	角码 GRU5506 5.869kg/m		25		
8	内开扇 GR65B83E GR65B83F 1.919kg/m		17	角码 JM5086 3.123kg/m		26		
9	135° 转角 GR65B87A GR65B87B 1.620kg/m		18	角码 JM6675 3.251kg/m		27		

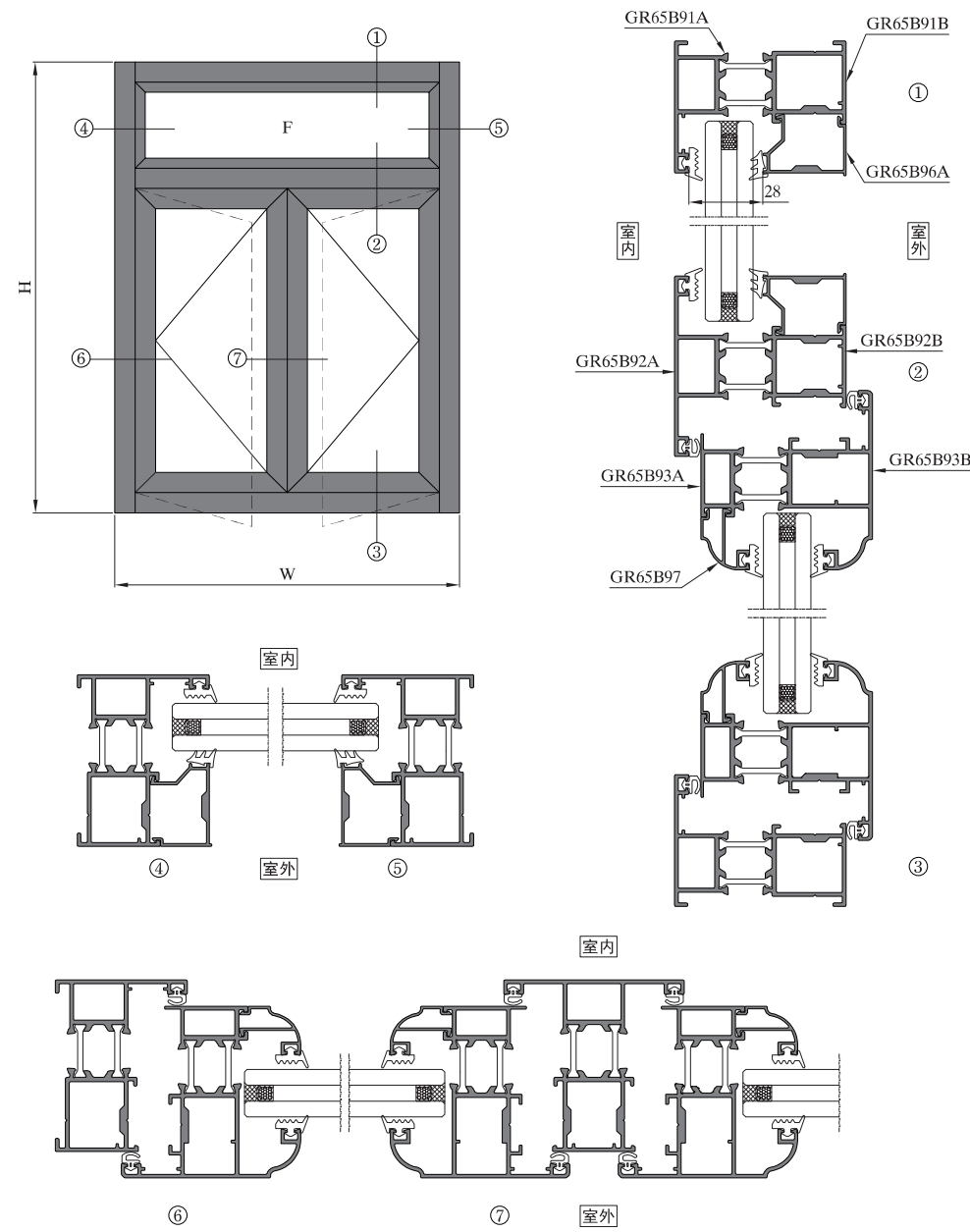

序号 S/N	型号理论重量 JMA Code & KG/M	型材图 Drawing	序号 S/N	型号理论重量 JMA Code & KG/M	型材图 Drawing	序号 S/N	型号理论重量 JMA Code & KG/M	型材图 Drawing
1	框料 GR65B91A GR65B91B 1.300kg/m		10	连接件 GR65B98 2.026kg/m		19		
2	中挺 GR65B92A GR65B92B 1.449kg/m		11	连接件 GR65B98A 0.820kg/m		20		
3	中挺 GR65B92B GR65B92C 2.182kg/m		12	角码 GR65B98B 3.397kg/m		21		
4	扇料 GR65B93A GR65B93B 1.486kg/m		13	角码 GR65B45A 5.054kg/m		22		
5	扇料 GR65B93C GR65B93D 1.896kg/m		14	压线 GR65B96A 0.293kg/m		23		
6	隔热转角 GR65B94A GR65B94B 2.196kg/m		15	角码 JM5508 3.533kg/m		24		
7	假中挺 GR65B95A GR65B95B 1.182kg/m		16			25		
8	压线 GR65B96 0.204kg/m		17			26		
9	压线 GR65B97 0.203kg/m		18			27		

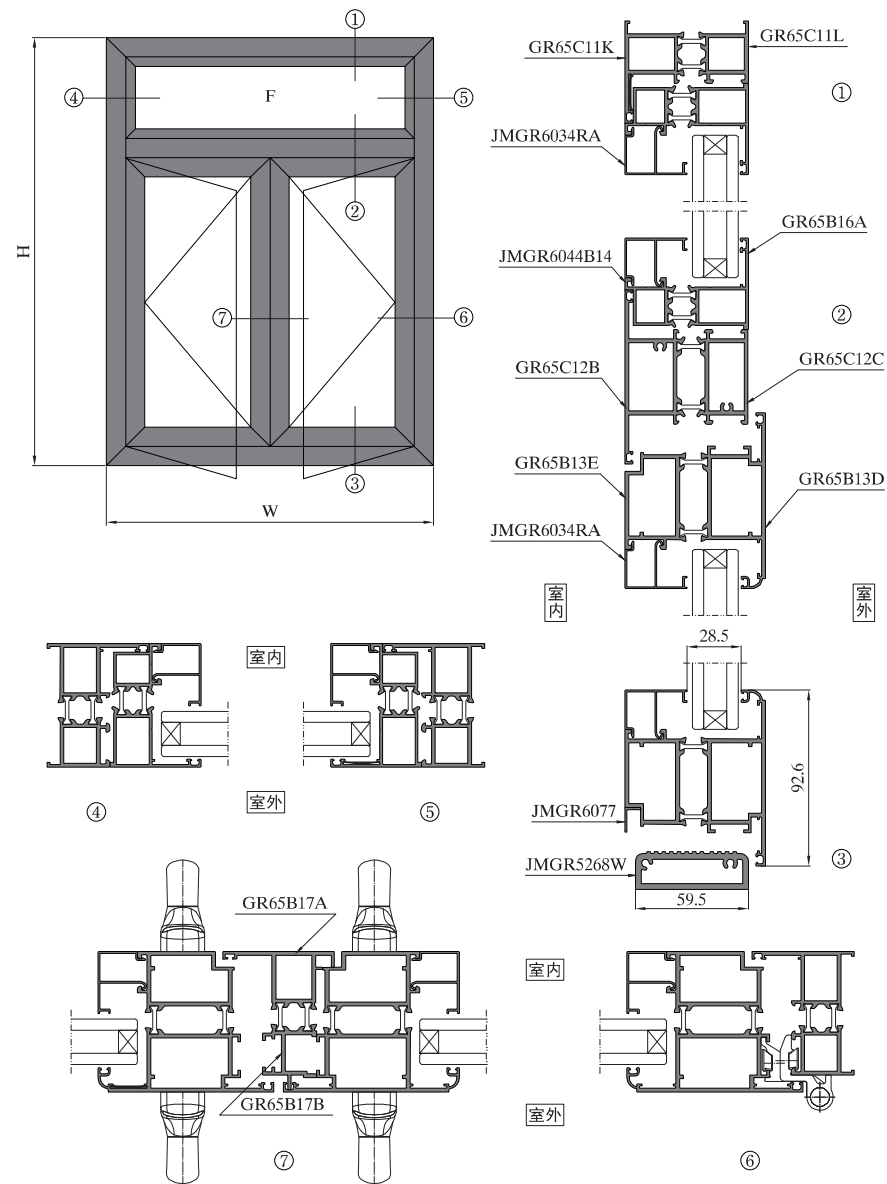

序号 S/N	型号理论重量 JMA Code & KG/M	型材图 Drawing	序号 S/N	型号理论重量 JMA Code & KG/M	型材图 Drawing	序号 S/N	型号理论重量 JMA Code & KG/M	型材图 Drawing
28	压线 JMGR6034A 0.189kg/m	开口41mm 	37	转角 GRC6507A GRC6507B 1.686kg/m		46		
29	压线 JMGR6034AG 0.175kg/m	配JMGR6037B 开口41mm 	38	角码 JMGR5270A 2.645kg/m		47		
30	压线底座 JMGR6037B 0.172kg/m		39	角码 JMGR6047A 2.861kg/m		48		
31	拼料 JMGR6040A14 JMGR6040A14 1.078kg/m		40	角码 JMGR55B47G 3.358kg/m		49		
32	门槛 JMGR5268W 1.416kg/m		41	角码 JMGR511128 3.234kg/m		50		
33	封边 JMGR6077 0.070kg/m		42			51		
34	拼料 GRC6507E GRC6507E 0.523kg/m		43			52		
35	转角 JMGR1059A JMGR1059B 1.266kg/m		44			53		
36	转角 GRC6507C GRC6507D 1.423kg/m		45			54		

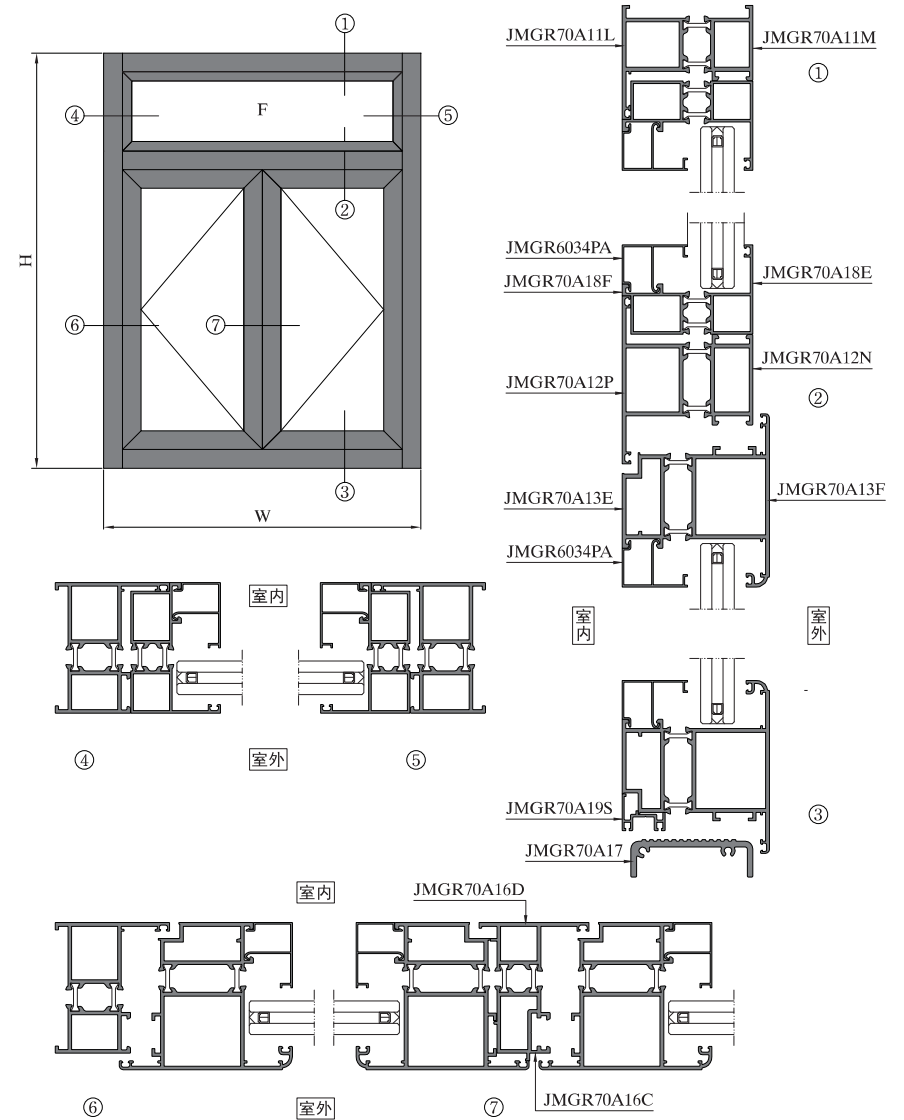

图中所示型材截面、装配、编号、尺寸及重量仅供参考。如有疑问，请向本公司查询。
Information above just for your reference. Please contact us if you have any questions, Thank you!

图中所示型材截面、装配、编号、尺寸及重量仅供参考。如有疑问，请向本公司查询。
Information above just for your reference. Please contact us if you have any questions, Thank you!

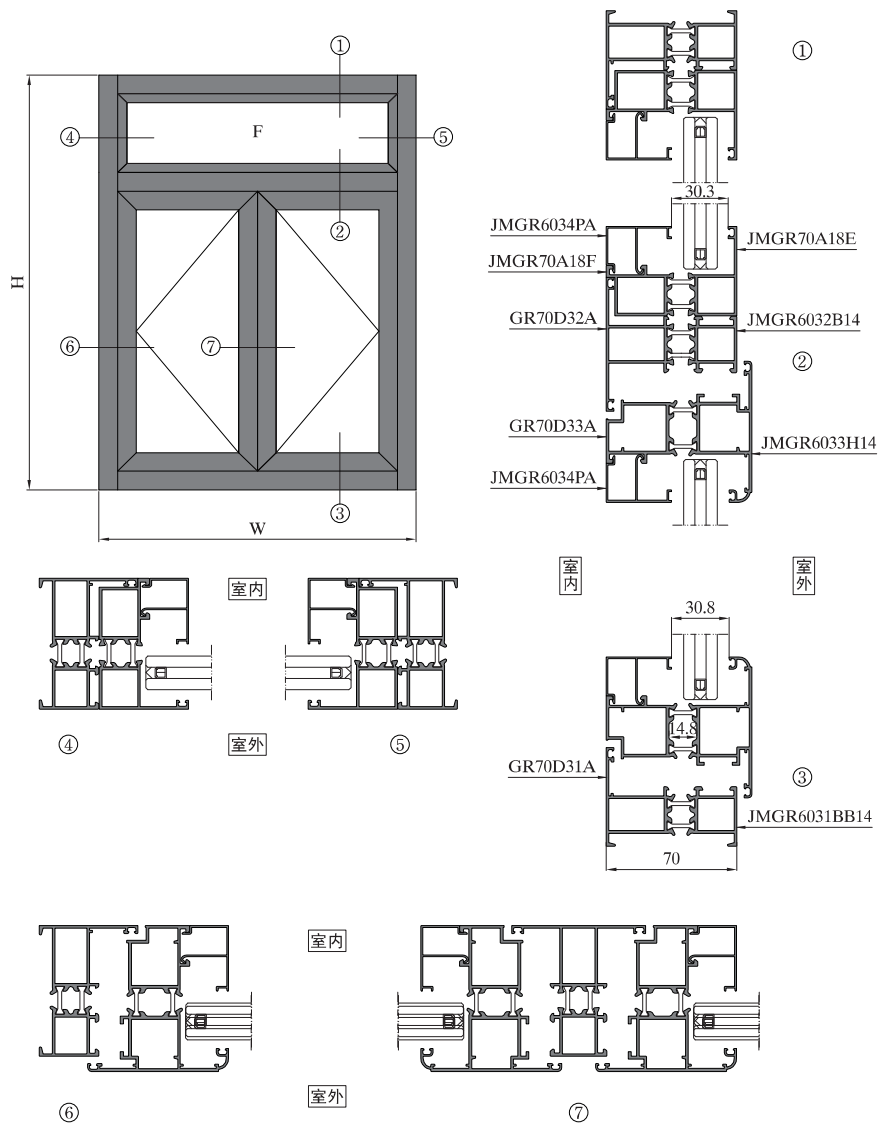

序号 S/N	型号理论重量 JMA Code & KG/M	型材图 Drawing	序号 S/N	型号理论重量 JMA Code & KG/M	型材图 Drawing	序号 S/N	型号理论重量 JMA Code & KG/M	型材图 Drawing
1	框料 GR70D31A JMGR6031BB14 1.345kg/m	角码JMGR5270A GR70D31A JMGR6031BB14 52.6 1.4 14.8 17.2 70	10	窗假中挺 JMGR70A16G JMGR70A16H 1.518kg/m	JMGR70A16G JMGR70A16H 58.6 1.5 14.8 75	19	压线 JMGR6034RQ 0.207kg/m	配JMGR6037B 开口33mm 32.8 21.5 0.9
2	框料 JMGR70A11L JMGR70A11M 1.808kg/m	JMGR70A11L 角码JMGY18774 JMGR70A11M 61 2 14.8 70	11	门假中挺 JMGR70A16C JMGR70A16D 1.742kg/m	JMGR70A16D JMGR70A16C 58.9 2 14.8 74.1	20	压线 JMGR70A14E 0.244kg/m	开口37mm 28.8 25.6 0.9
3	框料 JMGR70A12H JMGR70A12P 2.074kg/m	JMGR70A12H 角码PC60B16 JMGR70A12P 69.2 2 14.8 34.4 70	12	压线 JMGR70A15H 0.301kg/m	开口25mm 40.8 25.6	21	压线 JMGR70A14 0.228kg/m	开口37mm 28.8 25.6 0.9
4	中挺 GR70D32A JMGR6032B14 1.456kg/m	GR70D32A JMGR6032B14 71.8 1.4 14.8 70	13	压线 JMGR70A14B 0.266kg/m	开口24.5mm 41.3 25.5 0.9	22	压线 JMGR70A14A 0.281kg/m	配JMGR6037B 开口37mm 28.8 21.5
5	中挺 JMGR70A12N JMGR70A12P 2.170kg/m	JMGR70A12P JMGR70A12N 70 14.8 2 90	14	压线 JMGR6034PA 0.272kg/m	开口30.8mm 35 25.6 1	23	压线 JMGR6034YE 0.220kg/m	开口42mm 23.8 25.6 0.9
6	中挺 JMGR70A12Q JMGR70A12P 2.861kg/m	JMGR70A12Q JMGR70A12P 90 2 14.8 120	15	压线 JMGR70A15 0.243kg/m	开口31mm 34.8 25.6 0.9	24	压线 JMGR6034B 0.213kg/m	开口42mm 23.8 25.6 0.9
7	外扇 GR70D33A JMGR6033H14 1.696kg/m	JMGR6033H14 角码JMGR6047A GR70D33A 75.4 1.4 14.8 24.8 78	16	压线 JMGR70A15A 0.315kg/m	配JMGR6037B 开口31mm 34.8 21.5	25	压线 JMGR6034F 0.184kg/m	配JMGR6037B 开口42mm 23.8 21.5 0.9
8	门扇 JMGR70A13E JMGR70A13F 2.480kg/m	角码JMGY11128 JMGR70A13F 92.6 2 40.8 14.8 78.8 JMGR70A13E	17	压线 JMGR6034RA 0.266kg/m	开口33mm 32.8 25.6 1	26	底座 JMGR6037B 0.172kg/m	9.7 18.2
9	转换框 JMGR70A18E JMGR70A18F 1.220kg/m	角码JMGR100007B JMGR70A18E JMGR70A18F 47.8 1.4 14.8 70	18	压线 JMGR6034RH 0.235kg/m	开口33mm 32.8 25.6 0.9	27	门槛 JMGR70A17 1.016kg/m	20 65.3

图中所示型材截面、装配、编号、尺寸及重量仅供参考。如有疑问，请向本公司查询。
Information above just for your reference. Please contact us if you have any questions, Thank you!

图中所示型材截面、装配、编号、尺寸及重量仅供参考。如有疑问，请向本公司查询。
Information above just for your reference. Please contact us if you have any questions, Thank you!

序号 S/N	型号理论重量 JMA Code & KG/M	型材图 Drawing	序号 S/N	型号理论重量 JMA Code & KG/M	型材图 Drawing	序号 S/N	型号理论重量 JMA Code & KG/M	型材图 Drawing
28	封边 JMGR70A19S 0.246kg/m		37	转角 JMGR7597C JMGR7638C 1.850kg/m		45		
29	角码 JMGR5270A 2.645kg/m					46		
30	角码 JMGR100007B 3.263kg/m		38			47		
31	角码 JMGY18774 2.485kg/m		39			48		
32	角码 JMGR6047A 2.861kg/m		40			49		
33	角码 PC60B16 2.484kg/m		41			50		
34	角码 JMGY11128 3.234kg/m		42			51		
35	拼料 JMGR7598A JMGR7598A 0.604kg/m		43			52		
36	转角 JMGR7598B GR80A18D 1.434kg/m		44			53		

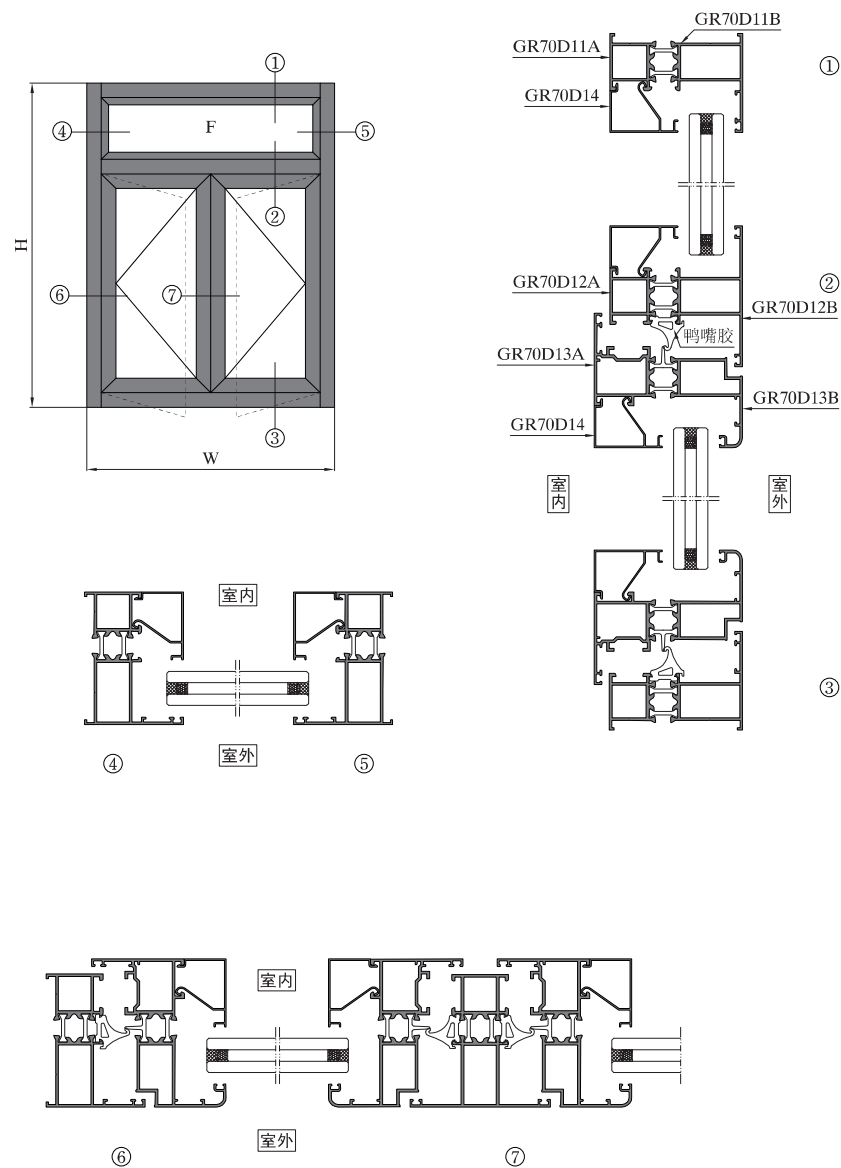

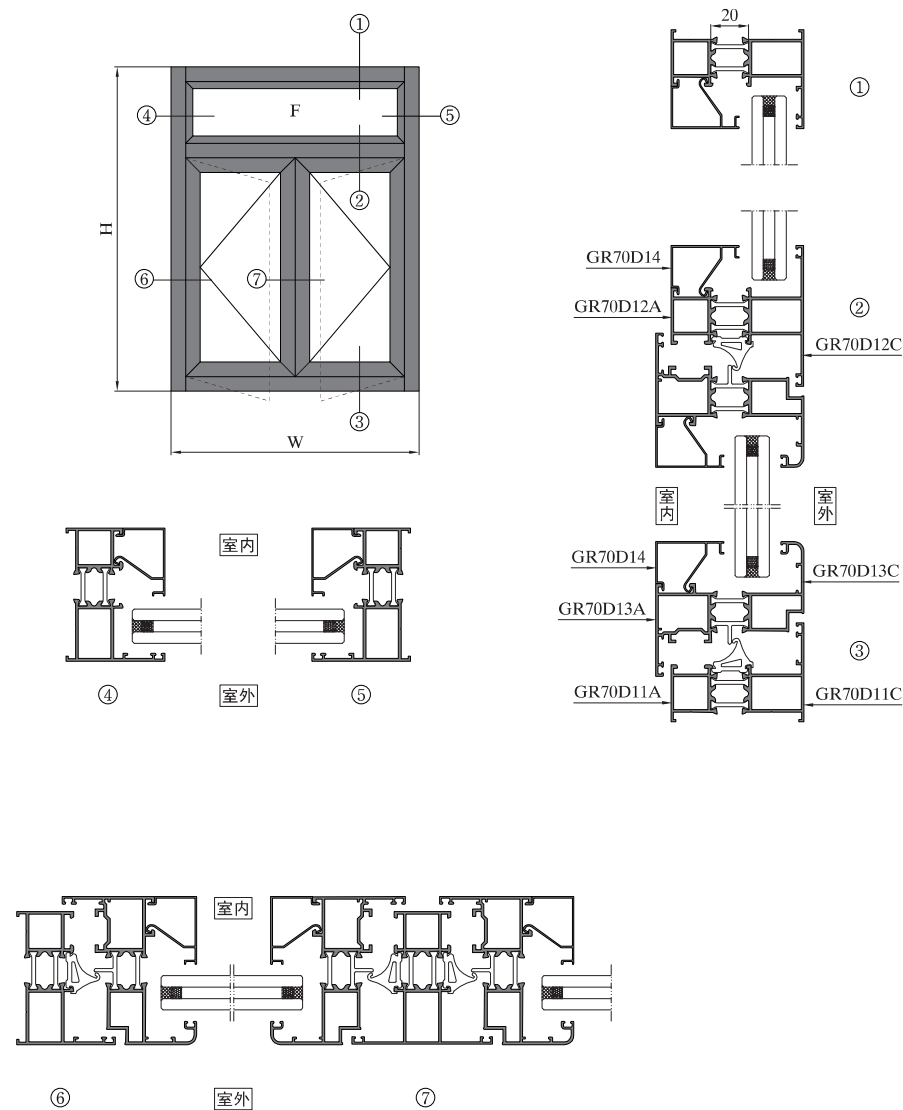
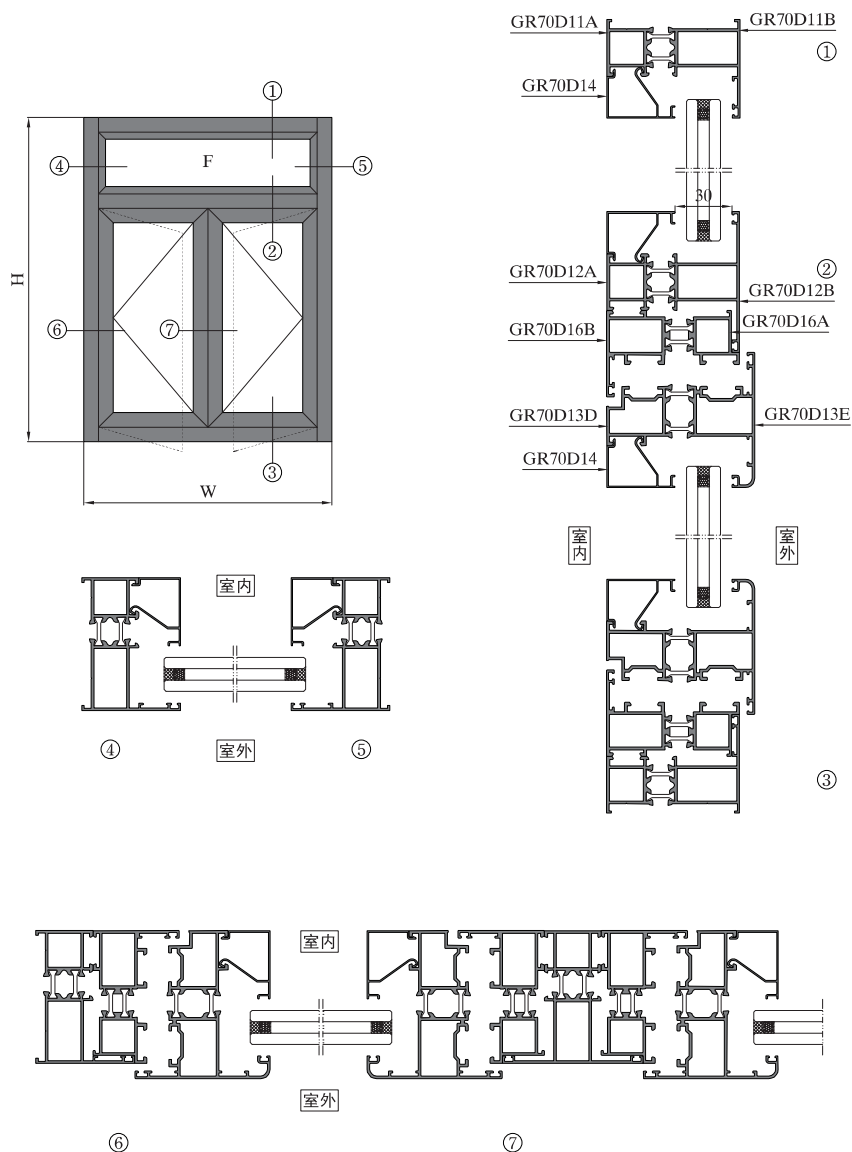

图中所示型材截面、装配、编号、尺寸及重量仅供参考。如有疑问，请向本公司查询。
Information above just for your reference. Please contact us if you have any questions, Thank you!

图中所示型材截面、装配、编号、尺寸及重量仅供参考。如有疑问，请向本公司查询。
Information above just for your reference. Please contact us if you have any questions, Thank you!

序号 S/N	型号理论重量 JMA Code & KG/M	型材图 Drawing	序号 S/N	型号理论重量 JMA Code & KG/M	型材图 Drawing	序号 S/N	型号理论重量 JMA Code & KG/M	型材图 Drawing
1	框料 GR70E51A GR70E51B 1.207kg/m		10	转换框 GR70E58A GR70E58B 1.156kg/m		19	角码 GRB506 2.991kg/m	
2	中挺 GR70E52A GR70E52B 1.523kg/m		11	转角 GR70E57A GR70E57B 1.949kg/m		20	角码 JMGR6047 2.502kg/m	
3	中挺 GR70E52C GR70E52D 1.447kg/m		12	拼管 GR70E56A GR70E56B 0.788kg/m		21	连杆 JMGR6037N 0.161kg/m	
4	加强中挺 GR70E52C GR70E52F 1.804kg/m		13	压线 JMZJ5504E 0.266kg/m		22		
5	加强中挺 GR70E52C GR70E52E 1.968kg/m		14	压线 JMZJ550410 0.241kg/m		23		
6	扇料 GR70E53B GR70E53D 1.689kg/m		15	压线 GR70E54 0.216kg/m		24	专配扇料GR70E53A+GR70E53B GR70E53A+GR70E53C 18.8 玻璃开口39mm	
7	扇料 GR70E53C GR70E53D 1.629kg/m		16	压线 GR70E54A 0.246kg/m		25	专配扇料GR70E53A+GR70E53B GR70E53A+GR70E53C 23.8 玻璃开口34mm	
8	扇料 GR70E53A GR70E53B 1.609kg/m		17	压线 GR70E54E 0.232kg/m		26	专配扇料GR70E53A+GR70E53B GR70E53A+GR70E53C 18.8 玻璃开口39mm	
9	扇料 GR70E53A GR70E53C 1.549kg/m		18	压线 GR70E54F 0.274kg/m		27	专配扇料GR70E53A+GR70E53B GR70E53A+GR70E53C 27.8 玻璃开口30mm	

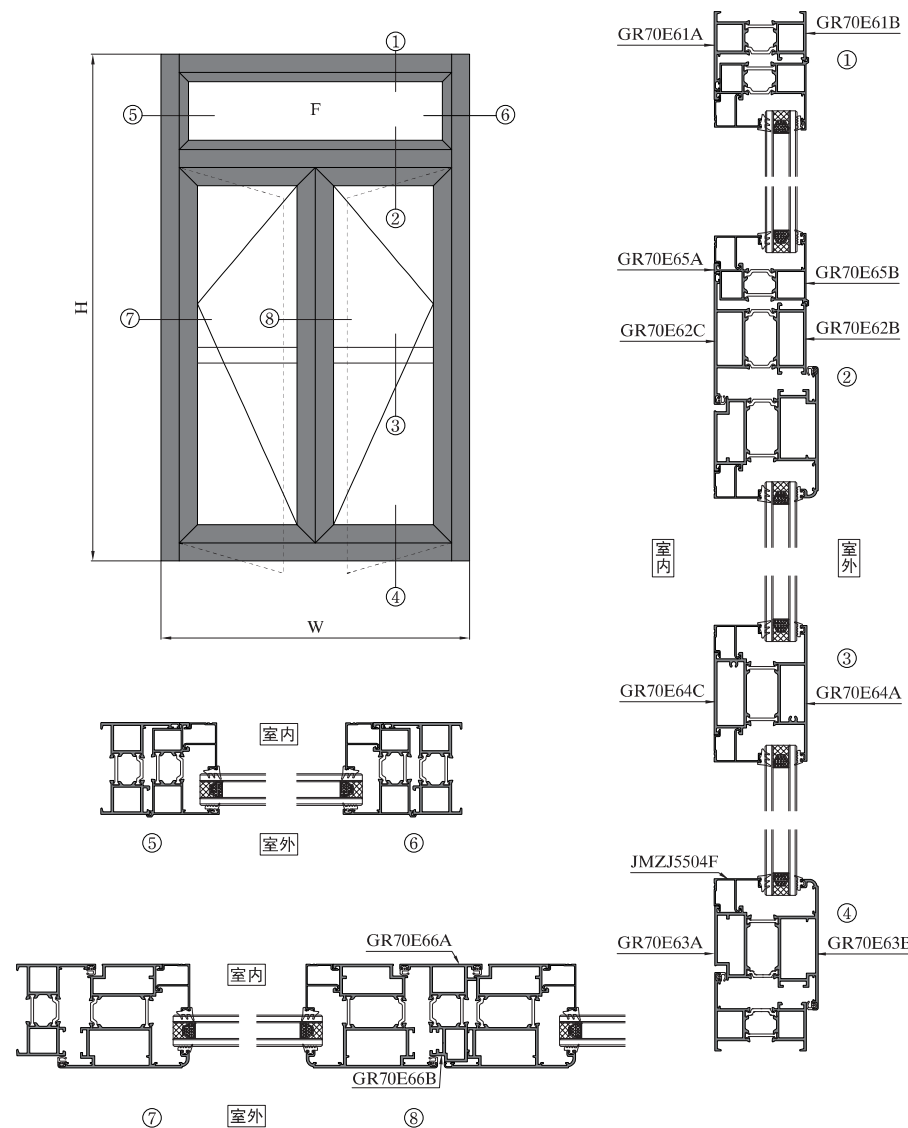

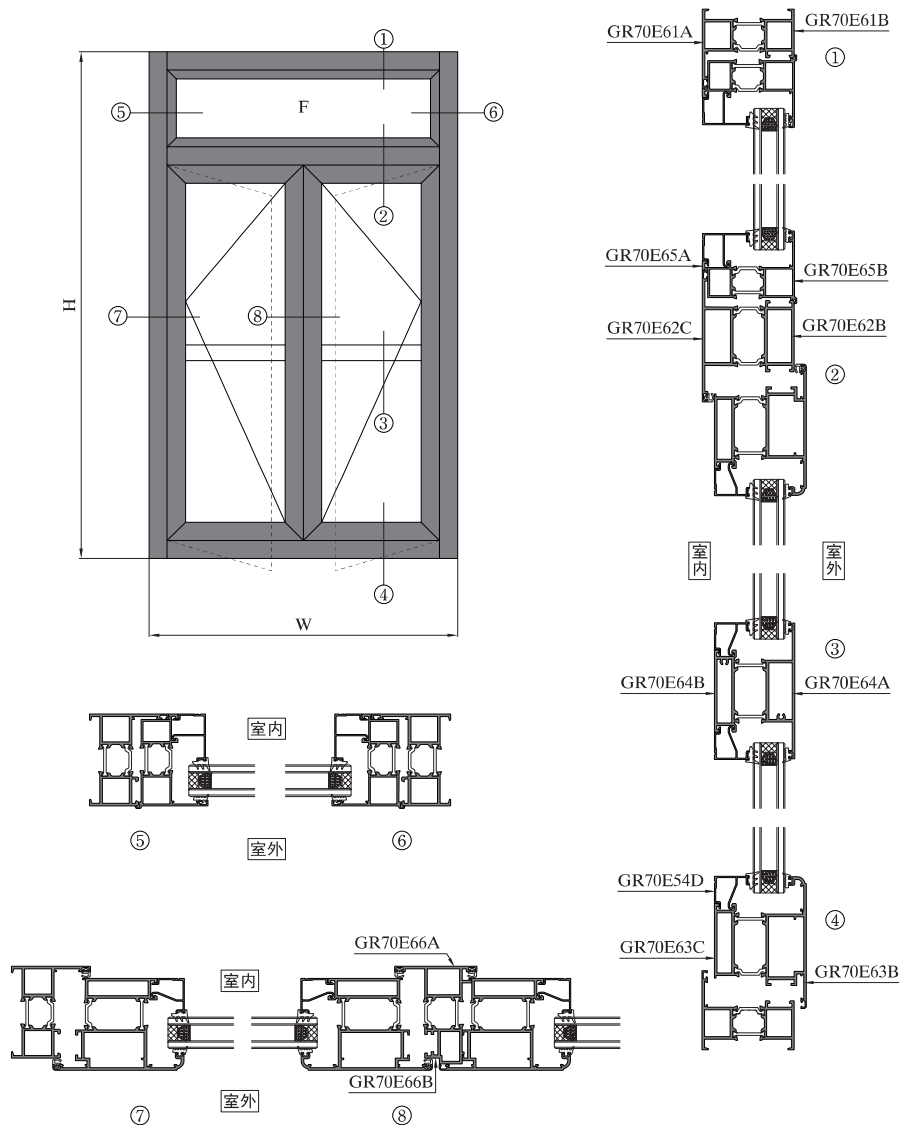

序号 S/N	型号理论重量 JMA Code & KG/M	型材图 Drawing	序号 S/N	型号理论重量 JMA Code & KG/M	型材图 Drawing	序号 S/N	型号理论重量 JMA Code & KG/M	型材图 Drawing
1	框料 GR70E61A GR70E61B 1.679kg/m		10	压线 JMZJ5504E 0.266kg/m		19		
2	中挺 GR70E62A GR70E62B 3.114kg/m		11	压线 JMZJ5504F 0.293kg/m		20		
3	中挺 GR70E62B GR70E62C 2.292kg/m		12	压线 JMZJ5504G 0.267kg/m		21		
4	扇料 GR70E63A GR70E63B 2.629kg/m		13	压线 GR70E54B 0.243kg/m		22		
5	扇料 GR70E63B GR70E63C 2.505kg/m		14	压线 GR70E54C 0.228kg/m		23		
6	中挺 GR70E64A GR70E64C 2.494kg/m		15	压线 GR70E54D 0.270kg/m		24		
7	中挺 GR70E64A GR70E64B 2.393kg/m		16	角码 JMGR5008A 2.381kg/m		25		
8	转换框 GR70E65A GR70E65B 1.286kg/m		17	角码 JMGR1711 5.664kg/m		26		
9	假中挺 GR70E66A GR70E66B 1.803kg/m		18	槽铝 JM252830 0.914kg/m		27		

图中所示型材截面、装配、编号、尺寸及重量仅供参考。如有疑问，请向本公司查询。
Information above just for your reference. Please contact us if you have any questions, Thank you!

图中所示型材截面、装配、编号、尺寸及重量仅供参考。如有疑问，请向本公司查询。
Information above just for your reference. Please contact us if you have any questions, Thank you!

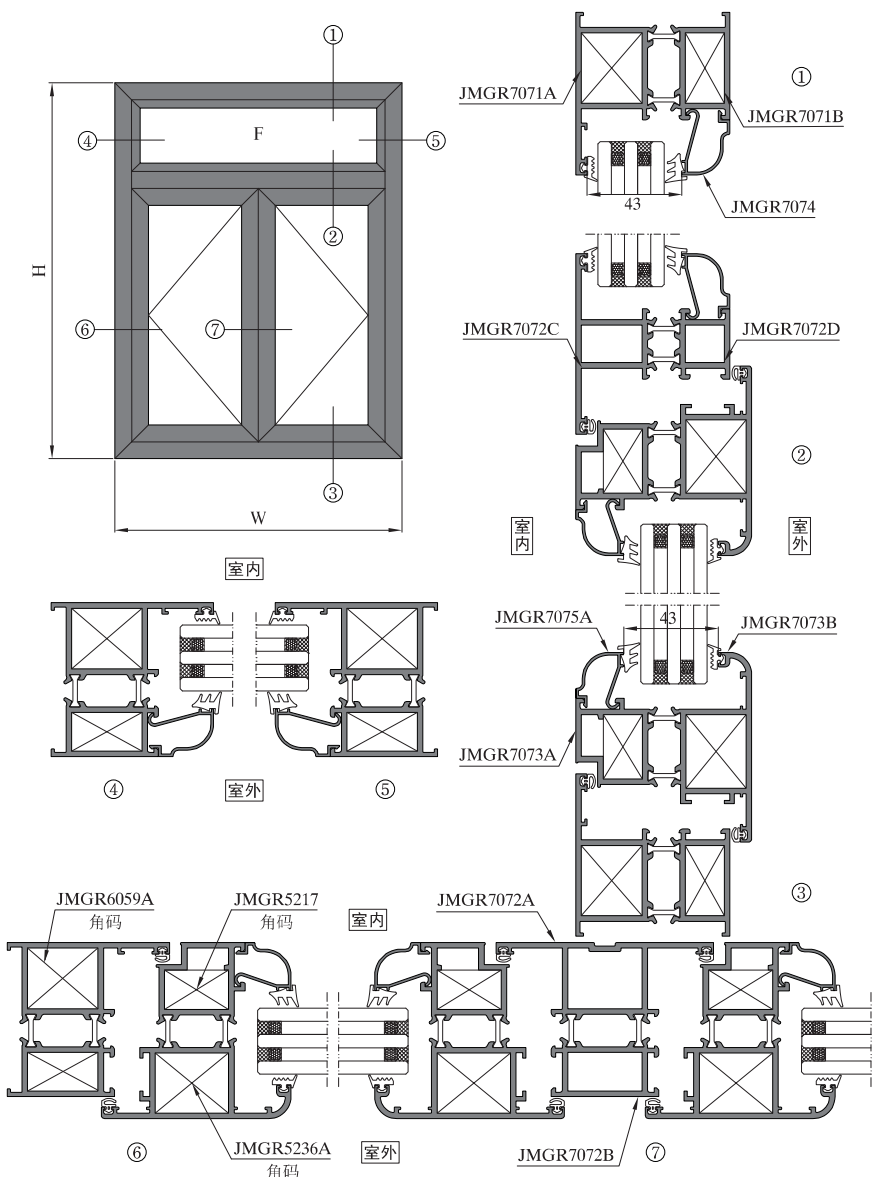

序号 S/N	型号理论重量 JMA Code & KG/M	型材图 Drawing	序号 S/N	型号理论重量 JMA Code & KG/M	型材图 Drawing
1	框料 JMGR7071A JMGR7071B 2.485kg/m		10	角码 JMGR5236A 6.706kg/m	
2	中挺 JMGR7072A JMGR7072B 2.809kg/m		11		
3	中挺 JMGR7072C JMGR7072D 2.296kg/m		12		
4	扇料 JMGR7073A JMGR7073B 2.806kg/m		13		
5	框料 JMGR7073C JMGR7073B 3.195kg/m		14		
6	压线 JMGR7074 0.287kg/m		15		
7	压线 JMGR7075A 0.258kg/m		16		
8	角码 JMGR6059A 4.263kg/m		17		
9	角码 JMGR5217 4.264kg/m		18		
			19		
			20		
			21		
			22		
			23		
			24		
			25		
			26		
			27		

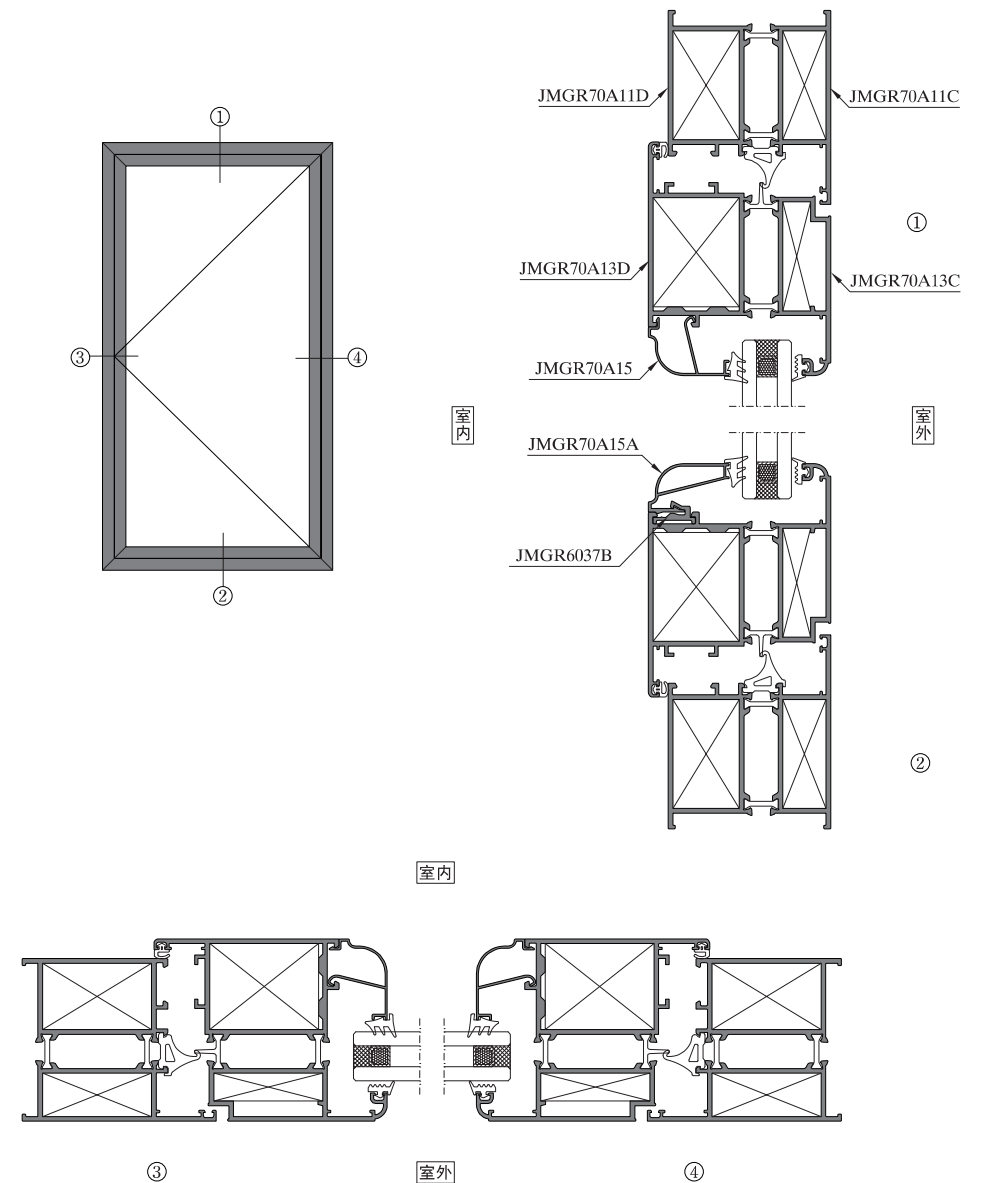
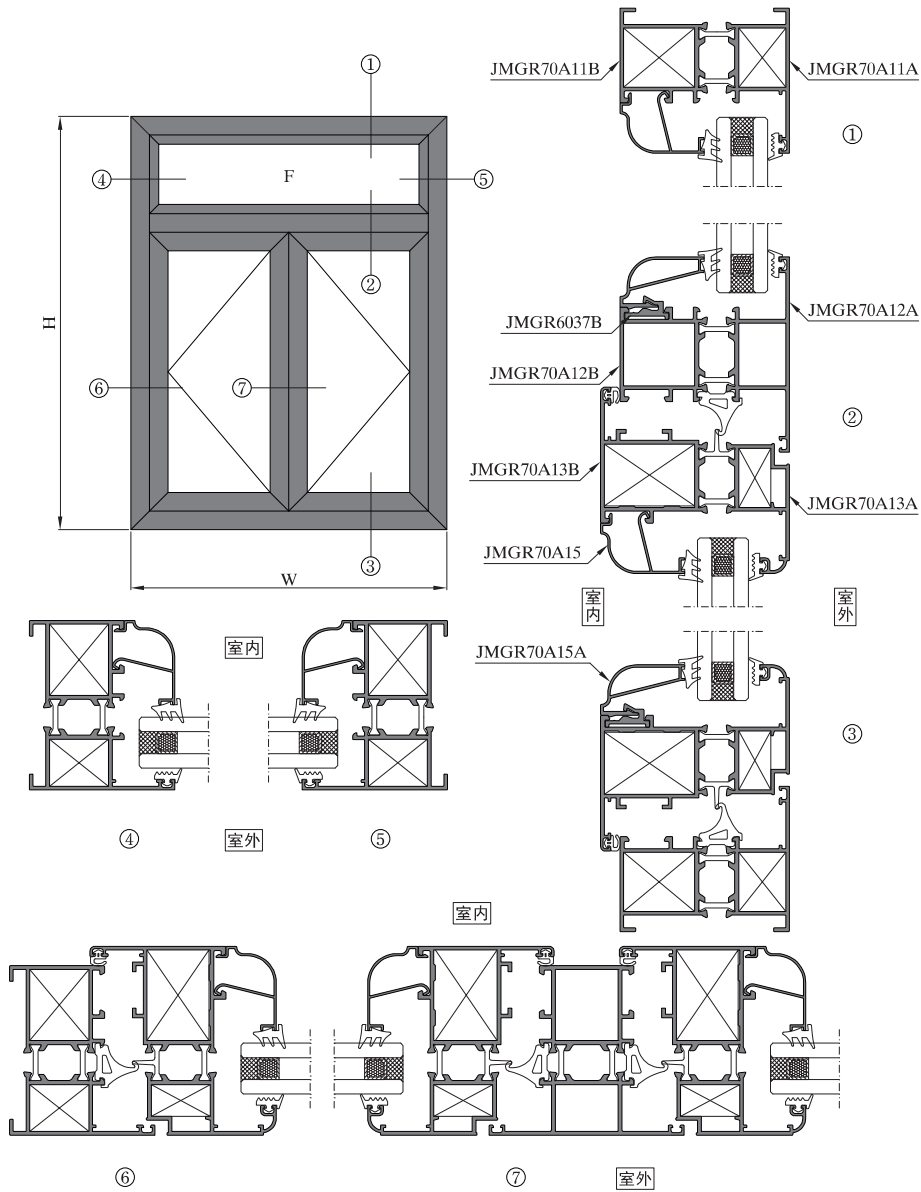

序号 S/N	型号理论重量 JMA Code & KG/M	型材图 Drawing	序号 S/N	型号理论重量 JMA Code & KG/M	型材图 Drawing	序号 S/N	型号理论重量 JMA Code & KG/M	型材图 Drawing
1	框料 JMGR70A11A JMGR70A11B 1.554kg/m		10	扇料 JMGR70A13E JMGR70A13F 2.480kg/m		19	转换料 JMGR70A18E JMGR70A18F 1.220kg/m	
2	框料 JMGR70A11C JMGR70A11D 2.409kg/m		11	外开扇 JMGR70A13J JMGR70A13K 1.782kg/m		20	压线辅件 JMGR6037B 0.172kg/m	
3	框料 JMGR70A11E JMGR70A11F 1.862kg/m		12	压线 JMGR70A14 0.228kg/m		21	角码 JMGR5206 2.351kg/m	
4	中挺 JMGR70A12A JMGR70A12B 1.724kg/m		13	压线 JMGR70A14A 0.281kg/m		22	角码 GR65B98B 3.397kg/m	
5	加强中挺 JMGR70A12C JMGR70A12D 2.742kg/m		14	压线 JMGR70A15 0.243kg/m		23	角码 B-5017A30 3.021kg/m	
6	中挺 JMGR70A12E JMGR70A12F 2.278kg/m		15	压线 JMGR70A15A 0.315kg/m		24	角码 JM5597 2.527kg/m	
7	中挺 JMGR70A12C JMGR70A12DA 1.799kg/m		16	外开扇 假中挺 JMGR70A16F JMGR70A16E 1.536kg/m		25	角码 JMGR2011 5.325kg/m	
8	扇料 JMGR70A13A JMGR70A13B 1.755kg/m		17	门樘 JMGR70A17 1.016kg/m		26	90° 转角 JMGR70A19C JMGR70A19D 2.429kg/m	
9	扇料 JMGR70A13C JMGR70A13D 2.697kg/m		18	转换料 JMGR70A18A JMGR70A18B 1.291kg/m		27	角码 GRU5506 5.869kg/m	

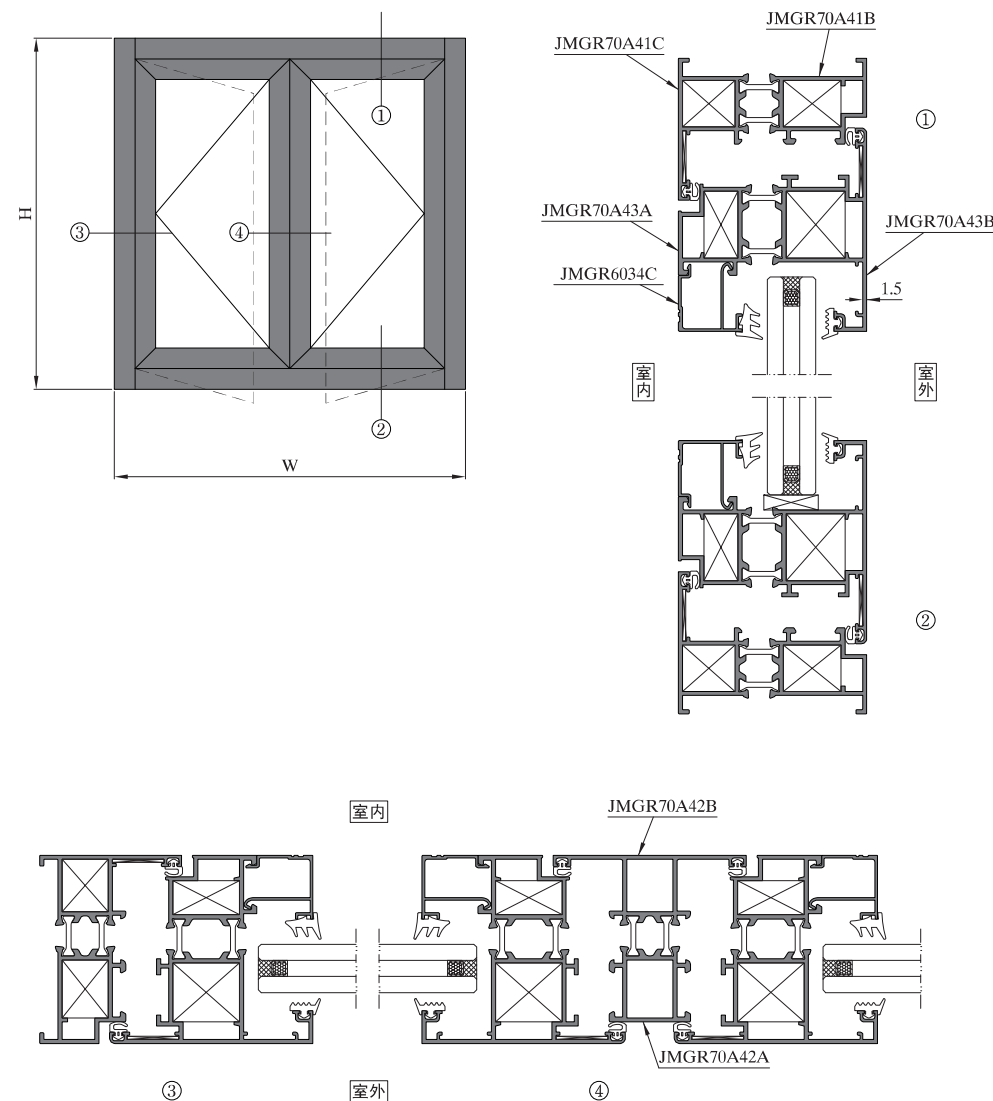

图中所示型材截面、装配、编号、尺寸及重量仅供参考。如有疑问，请向本公司查询。
Information above just for your reference. Please contact us if you have any questions, Thank you!

图中所示型材截面、装配、编号、尺寸及重量仅供参考。如有疑问，请向本公司查询。
Information above just for your reference. Please contact us if you have any questions, Thank you!

序号 S/N	型号理论重量 JMA Code & KG/M	型材图 Drawing	序号 S/N	型号理论重量 JMA Code & KG/M	型材图 Drawing	序号 S/N	型号理论重量 JMA Code & KG/M	型材图 Drawing
1	框料 JMGR70A41A JMGR70A41B 1.472kg/m		10			19		
2	框料 JMGR70A41B JMGR70A41C 1.373kg/m		11			20		
3	中挺 JMGR70A42A JMGR70A42B 1.433kg/m		12			21		
4	扇料 JMGR70A43A JMGR70A43B 1.678kg/m		13			22		
5	扇压线 JMGR6034C 0.247kg/m		14			23		
6	扇压线 JMGR6034EB 0.222kg/m		15			24		
7	角码 JMGR6036 2.278kg/m		16			25		
8	角码 JMGR6047A 2.861kg/m		17			26		
9			18			27		

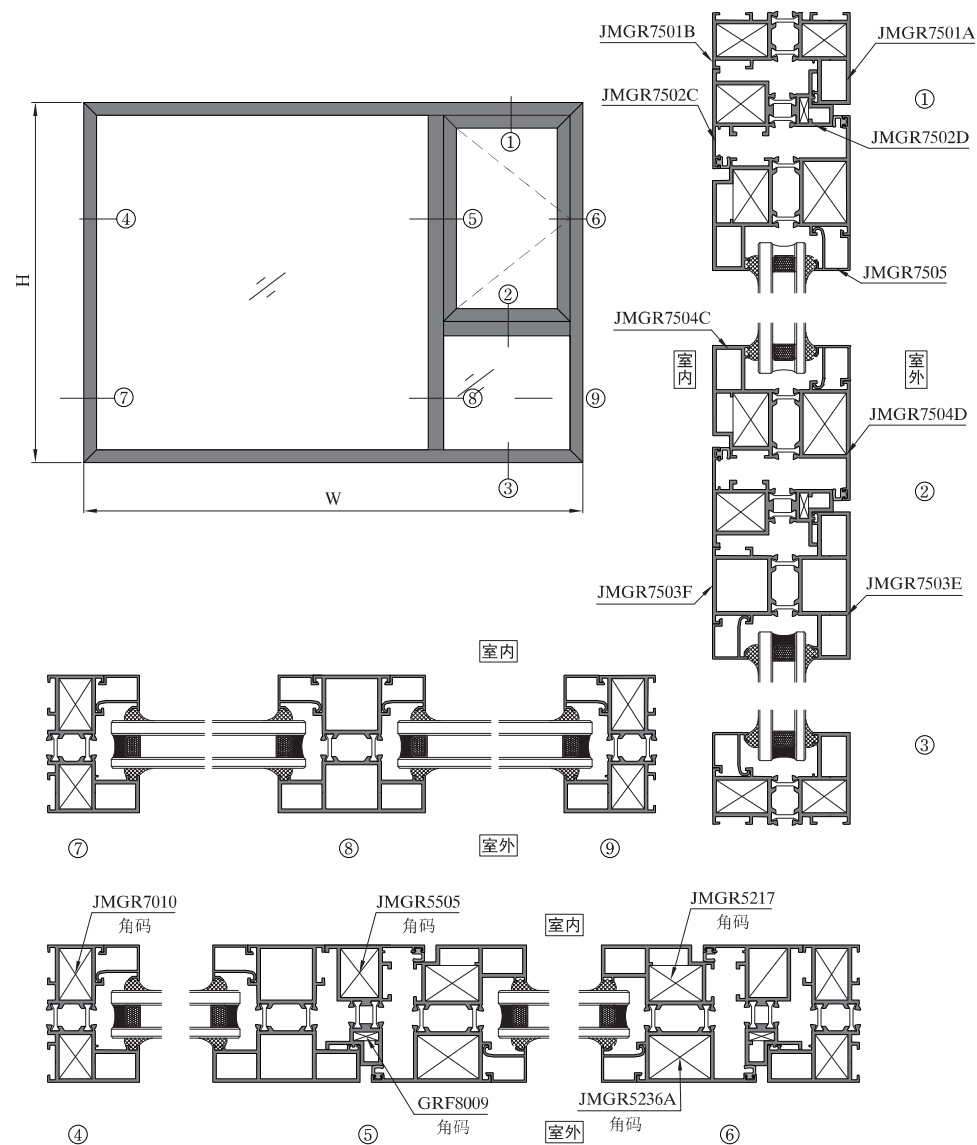

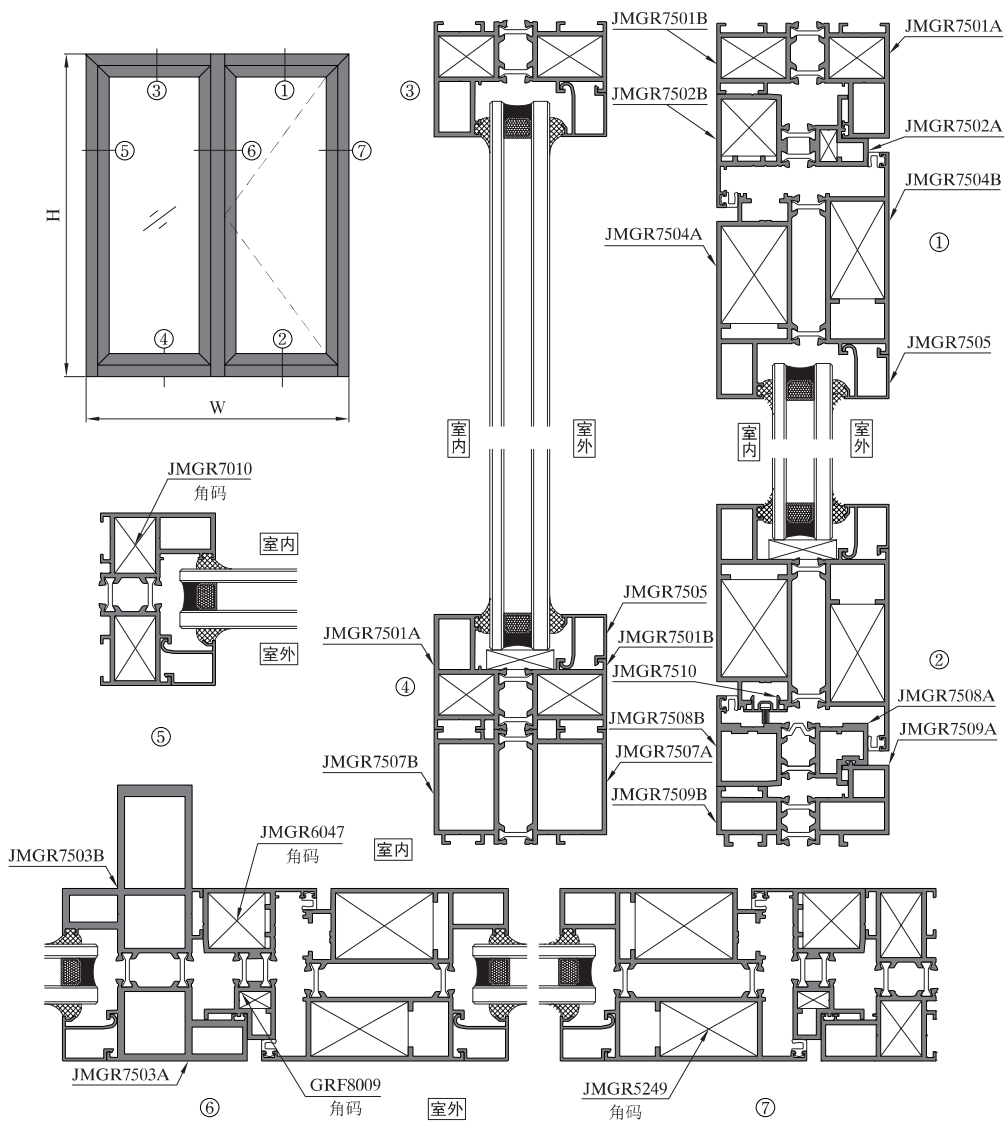

序号 S/N	型号理论重量 JMA Code & KG/M	型材图 Drawing	序号 S/N	型号理论重量 JMA Code & KG/M	型材图 Drawing	序号 S/N	型号理论重量 JMA Code & KG/M	型材图 Drawing
1	框料 JMGR7501A JMGR7501B 1.979kg/m	角码配JMGR7010 压线配JMGR7505 开口35mm 20.4 JMGR7501A JMGR7501B 50 17.8 14.8 2 75	10	框料 JMGR7507A JMGR7507B 2.119kg/m	JMGR7507B JMGR7507A 50 2 14.8 75	19	角码 JMGR5236A 6.706kg/m	33.1 80 80
2	转换料 JMGR7502A JMGR7502B 1.594kg/m	角码配JMGR6047 GRF8009 65.8 49.4 14.8 24.8 2 JMGR7502B JMGR7502A 13.5	11	转换料 JMGR7508A JMGR7508B 1.664kg/m	65.8 39.4 14.8 2 JMGR7508B JMGR7508A	20	角码 JMGR5249 7.907kg/m	42.1 90 90
3	转换料 JMGR7502C JMGR7502D 1.615kg/m 与JMGR7504CD 配合使用	角码配JMGR5505D JMGR6858 65.8 54.4 14.8 20.8 2 JMGR7502C JMGR7502D 13.8	12	框料 JMGR7509A JMGR7509B 1.754kg/m	JMGR7509A JMGR7509B 36.7 14.8 2 75	21	角码 JMGR5505D 4.125kg/m	20.5 69 69
4	中柱 JMGR7503A JMGR7503B 4.437kg/m	压线配JMGR7505 玻璃开口35mm JMGR7503A 14.8 JMGR7503B 80.4 61.2 75 120	13	收口 JMGR7510 0.110kg/m	19 7.16	22	角码 JMGR6858 2.601kg/m	13.5 58 58
5	扇料 JMGR7503C JMGR7503D 4.324kg/m	JMGR7503D JMGR7503C 14.8 86.6 75 120	14	压线 JMGR7505 0.267kg/m	玻璃开口35mm 1.2 19.6 23.7 16.3	23		
6	中挺 JMGR7503E JMGR7503F 2.512kg/m	压线配JMGR7505 玻璃开口35mm JMGR7503E JMGR7503F 14.8 80.4 75	15	角码 JMGR6047 2.502kg/m	24.5 60 60	24		
7	扇料 JMGR7504A JMGR7504B 3.083kg/m	角码配JMGR5249 压线配JMGR7505 开口35mm JMGR7504A JMGR7504B 107.3 42.4 14.8 75	16	角码 GRF8009 3.525kg/m	13.1 60 60	25		
8	扇料 JMGR7504C JMGR7504D 2.352kg/m	角码配JMGR5217 JMGR5236A 压线配JMGR7505 玻璃开口35mm 14.8 61.5 20 75 JMGR7504C JMGR7504D	17	角码 JMGR7010 2.968kg/m	17.5 60 60	26		
9	假中挺 JMGR7504E JMGR7504F 1.761kg/m	JMGR7504E JMGR7504F 54.2 14.8 73.1	18	角码 JMGR5217 4.264kg/m	28.8 85 85	27		

图中所示型材截面、装配、编号、尺寸及重量仅供参考。如有疑问，请向本公司查询。
Information above just for your reference. Please contact us if you have any questions, Thank you!

图中所示型材截面、装配、编号、尺寸及重量仅供参考。如有疑问，请向本公司查询。
Information above just for your reference. Please contact us if you have any questions, Thank you!

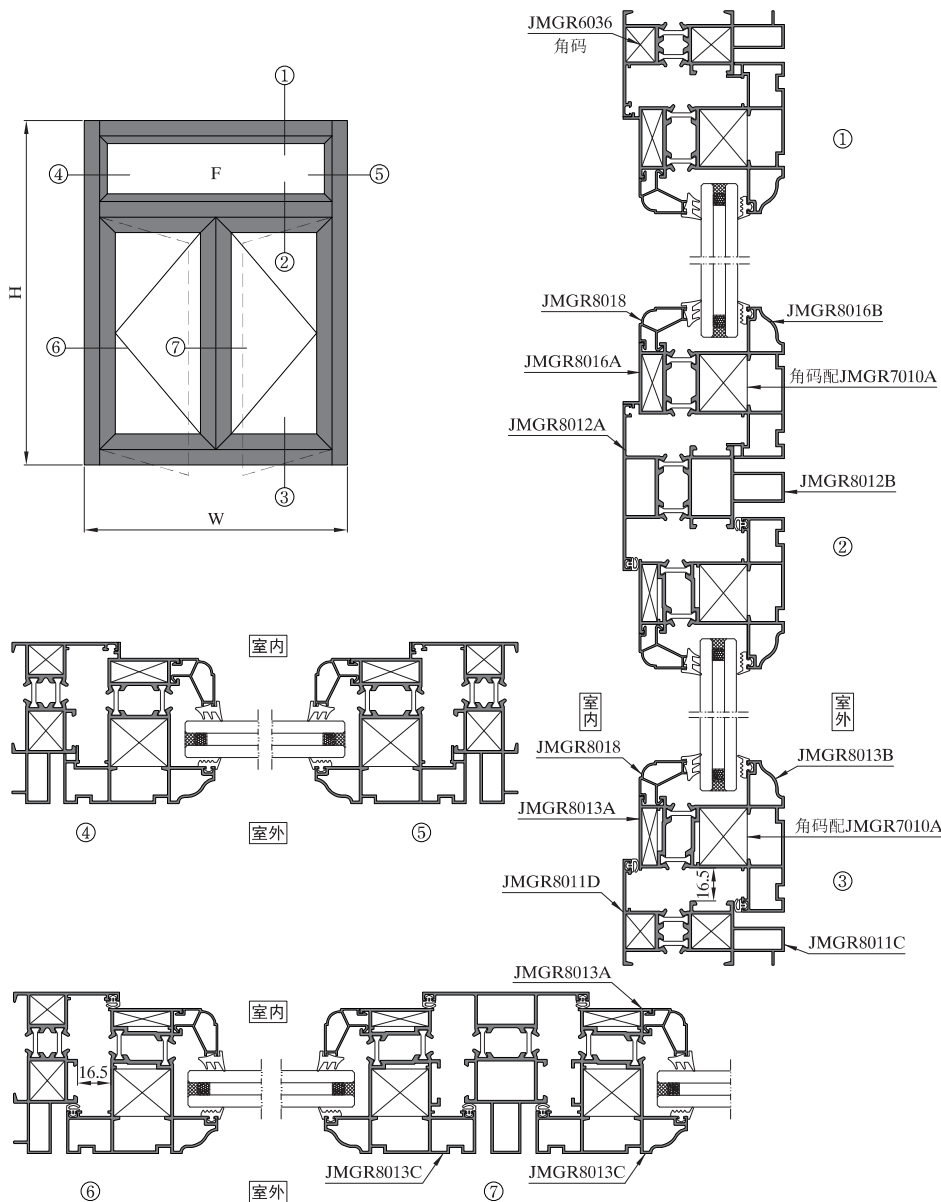

序号 S/N	型号理论重量 JMA Code & KG/M	型材图 Drawing	序号 S/N	型号理论重量 JMA Code & KG/M	型材图 Drawing	序号 S/N	型号理论重量 JMA Code & KG/M	型材图 Drawing
1	框料 JMGR8011A JMGR8011B 2.468kg/m		10	扇料 JMGR8016C JMGR8016D 2.205kg/m		19		
2	框料 JMGR8011C JMGR8011D 1.430kg/m		11	转角 JMGR8017C JMGR5086K 2.016kg/m		20		
3	中挺 JMGR8012A JMGR8012B 1.715kg/m		12	压线 JMGR8018 0.228kg/m		21		
4	中挺 JMGR8012C JMGR8012D 2.419kg/m		13	角码 JMGR7010A 5.431kg/m		22		
5	扇料 JMGR8013A JMGR8013B 1.844kg/m		14	角码 JMGR1711 5.664kg/m		23		
6	扇料 JMGR8013A JMGR8013C 1.905kg/m		15	角码 JMGR6036 2.278kg/m		24		
7	扇料 JMGR8013D JMGR8013E 2.590kg/m		16	中挺连接件 JM252830 0.914kg/m		25		
8	转换料 JMGR8015A JMGR8015B 1.327kg/m		17	中挺连接件 JM241130 0.634kg/m		26		
9	扇料 JMGR8016A JMGR8016B 1.874kg/m		18			27		

图中所示型材截面、装配、编号、尺寸及重量仅供参考。如有疑问，请向本公司查询。
Information above just for your reference. Please contact us if you have any questions, Thank you!

图中所示型材截面、装配、编号、尺寸及重量仅供参考。如有疑问，请向本公司查询。
Information above just for your reference. Please contact us if you have any questions, Thank you!

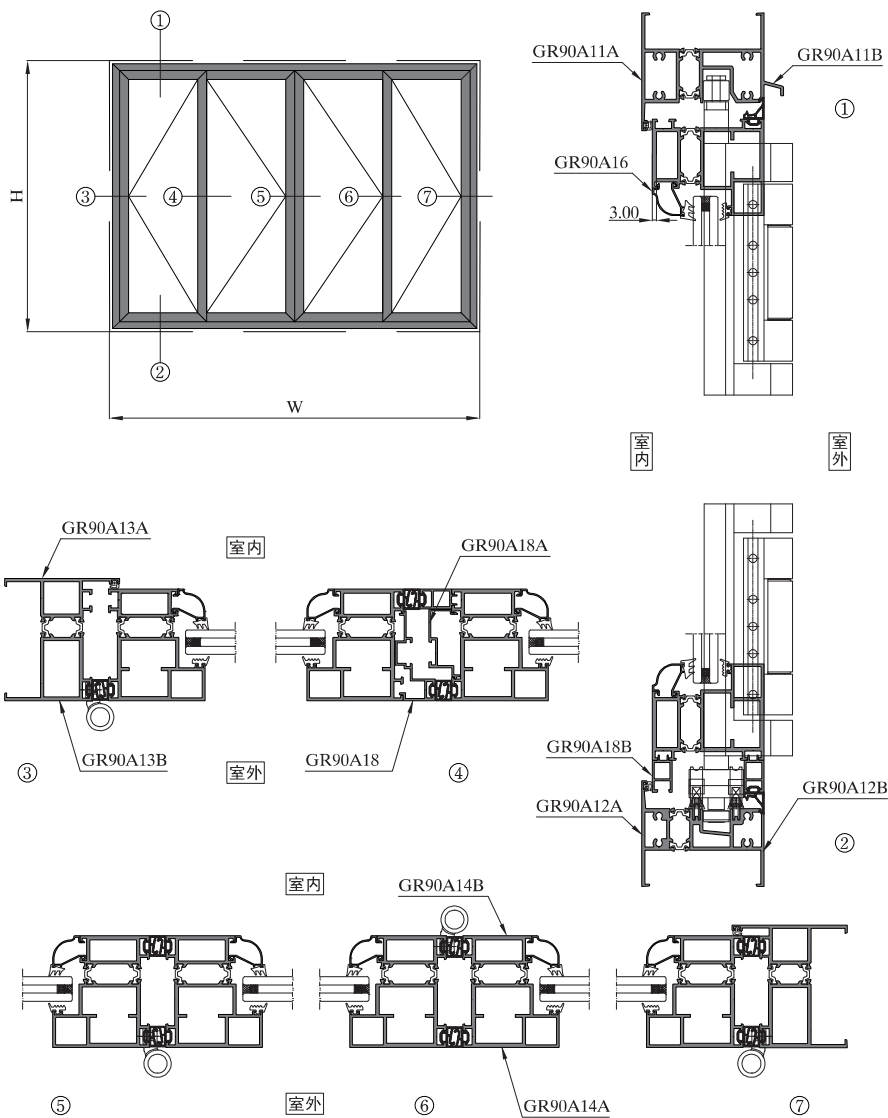



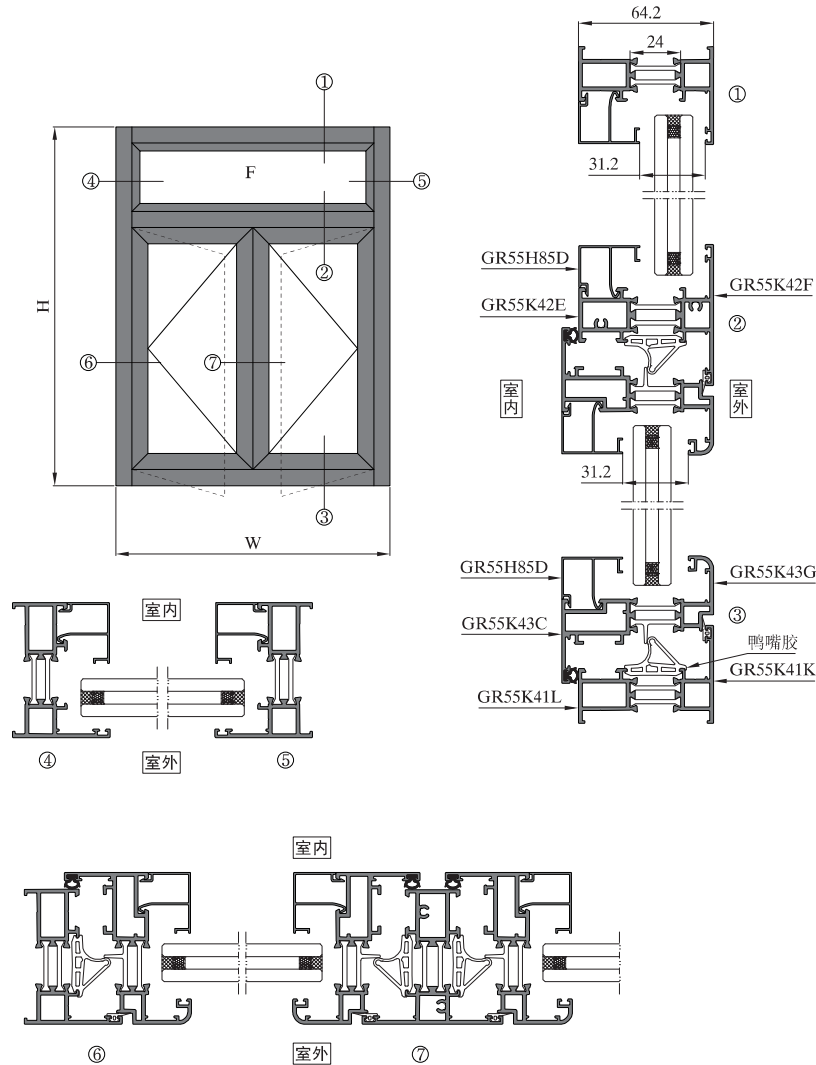

序号 S/N	型号理论重量 JMA Code & KG/M	型材图 Drawing	序号 S/N	型号理论重量 JMA Code & KG/M	型材图 Drawing	序号 S/N	型号理论重量 JMA Code & KG/M	型材图 Drawing
1	GR90A11A 3.385kg/m		10	GR90A18C 0.238kg/m		19		
2	GR90A12A GR90A12B 3.232kg/m		11			20		
3	GR90A13A GR90A13B 2.927kg/m		12			21		
4	GR90A14A GR90A14B 3.141kg/m		13			22		
5	GR90A14C GR90A14D 3.118kg/m		14			23		
6	GR90A16 0.201kg/m		15			24		
7	GR90A18 0.665kg/m		16			25		
8	GR90A18A 0.438kg/m		17			26		
9	GR90A18B 0.345kg/m		18			27		

图中所示型材截面、装配、编号、尺寸及重量仅供参考。如有疑问，请向本公司查询。
Information above just for your reference. Please contact us if you have any questions, Thank you!

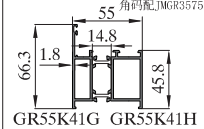
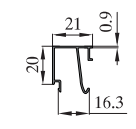
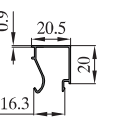
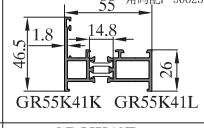
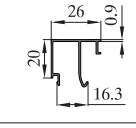
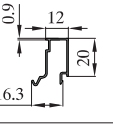
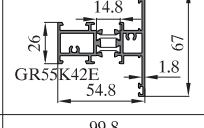
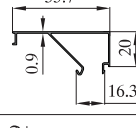
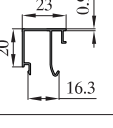
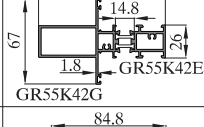
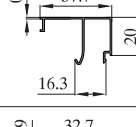
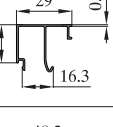
图中所示型材截面、装配、编号、尺寸及重量仅供参考。如有疑问，请向本公司查询。
Information above just for your reference. Please contact us if you have any questions, Thank you!

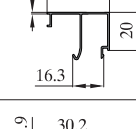
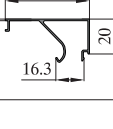
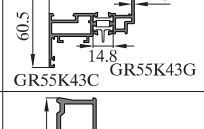
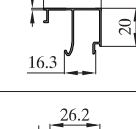
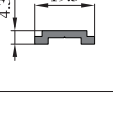
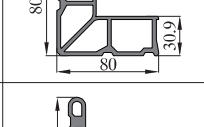
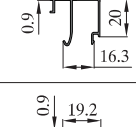
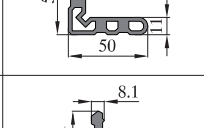
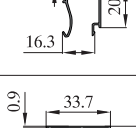

序号 S/N	型号理论重量 JMA Code & KG/M	型材图 Drawing	序号 S/N	型号理论重量 JMA Code & KG/M	型材图 Drawing	序号 S/N	型号理论重量 JMA Code & KG/M	型材图 Drawing
1	框料 GR55K41G GR55K41H T=1.8 1.647kg/m		10	压线 GR55K35A T=0.9 0.222kg/m		19	压线 GR55H85A T=0.9 0.206kg/m	
2	框料 GR55K41K GR55K41L T=1.8 1.202kg/m		11	压线 GR55K35B T=0.9 0.235kg/m		20	压线 GR55H85B T=0.9 0.187kg/m	
3	中挺 GR55K42E GR55K42F T=1.8 1.484kg/m		12	压线 GR55K35C T=0.9 0.335kg/m		21	压线 GR55H85C T=0.9 0.228kg/m	
4	加强中挺 GR55K42E GR55K42G T=1.8 2.084kg/m		13	压线 GR55K35D T=0.9 0.266kg/m		22	压线 GR55H85D T=0.9 0.243kg/m	
5	加强中挺 GR55K42E GR55K42H T=1.8 1.955kg/m		14	压线 GR55K35E T=0.9 0.253kg/m		23	压线 GR55H85E T=0.9 0.311kg/m	
6	内开扇 GR55K43C GR55K43G T=1.8 1.449kg/m		15	压线 GR55K35F T=0.9 0.246kg/m		24	传动杆 JMGR5507A 0.153kg/m	
7	角码 JMGR3575 T=3.0 3.470kg/m		16	压线 GR55K35G T=0.9 0.235kg/m		25		
8	角码 F-50625 T=2.5 1.786kg/m		17	压线 GR55K35K T=0.9 0.201kg/m		26		
9	角码 PC3855A 1.307kg/m		18	压线 GR55K35M T=0.9 0.256kg/m		27		

序号 S/N	型号理论重量 JMA Code & KG/M	型材图 Drawing	序号 S/N	型号理论重量 JMA Code & KG/M	型材图 Drawing	序号 S/N	型号理论重量 JMA Code & KG/M	型材图 Drawing
1	框料 GR55K41G GR55K41H T=1.8 1.673kg/m		10	压线 GR55K35A T=0.9 0.222kg/m		19	压线 GR55H85A T=0.9 0.206kg/m	
2	框料 GR55K41K GR55K41L T=1.8 1.228kg/m		11	压线 GR55K35B T=0.9 0.235kg/m		20	压线 GR55H85B T=0.9 0.187kg/m	
3	中挺 GR55K42E GR55K42F T=1.8 1.510kg/m		12	压线 GR55K35C T=0.9 0.335kg/m		21	压线 GR55H85C T=0.9 0.228kg/m	
4	加强中挺 GR55K42E GR55K42G T=1.8 2.110kg/m		13	压线 GR55K35D T=0.9 0.266kg/m		22	压线 GR55H85D T=0.9 0.243kg/m	
5	加强中挺 GR55K42E GR55K42H T=1.8 1.981kg/m		14	压线 GR55K35E T=0.9 0.253kg/m		23	压线 GR55H85E T=0.9 0.311kg/m	
6	内开扇 GR55K43G GR55K43C T=1.8 1.480kg/m		15	压线 GR55K35F T=0.9 0.246kg/m		24	传动杆 JMGR5507A 0.153kg/m	
7	角码 JMGR3575 T=3.0 3.470kg/m		16	压线 GR55K35G T=0.9 0.235kg/m		25		
8	角码 F-50625 T=2.5 1.786kg/m		17	压线 GR55K35K T=0.9 0.201kg/m		26		
9	角码 PC3855A 1.307kg/m		18	压线 GR55K35M T=0.9 0.256kg/m		27		

序号 S/N	型号理论重量 JMA Code & KG/M	型材图 Drawing	序号 S/N	型号理论重量 JMA Code & KG/M	型材图 Drawing	序号 S/N	型号理论重量 JMA Code & KG/M	型材图 Drawing
1	框料 GR55K41G GR55K41H T=1.8 1.703kg/m		10	压线 GR55K35A T=0.9 0.222kg/m		19	压线 GR55H85A T=0.9 0.206kg/m	
2	框料 GR55K41K GR55K41L T=1.8 1.258kg/m		11	压线 GR55K35B T=0.9 0.235kg/m		20	压线 GR55H85B T=0.9 0.187kg/m	
3	中挺 GR55K42E GR55K42F T=1.8 1.540kg/m		12	压线 GR55K35C T=0.9 0.335kg/m		21	压线 GR55H85C T=0.9 0.228kg/m	
4	加强中挺 GR55K42E GR55K42G T=1.8 2.141kg/m		13	压线 GR55K35D T=0.9 0.266kg/m		22	压线 GR55H85D T=0.9 0.243kg/m	
5	加强中挺 GR55K42E GR55K42H T=1.8 2.011kg/m		14	压线 GR55K35E T=0.9 0.253kg/m		23	压线 GR55H85E T=0.9 0.311kg/m	
6	内开扇 GR55K43G GR55K43C T=1.8 1.506kg/m		15	压线 GR55K35F T=0.9 0.246kg/m		24	传动杆 JMGR5507A 0.153kg/m	
7	角码 JMGR3575 T=3.0 3.470kg/m		16	压线 GR55K35G T=0.9 0.235kg/m		25		
8	角码 F-50625 T=2.5 1.786kg/m		17	压线 GR55K35K T=0.9 0.201kg/m		26		
9	角码 PC3855A 1.307kg/m		18	压线 GR55K35M T=0.9 0.256kg/m		27		

图中所示型材截面、装配、编号、尺寸及重量仅供参考。如有疑问，请向本公司查询。
 Information above just for your reference. Please contact us if you have any questions, Thank you!

图中所示型材截面、装配、编号、尺寸及重量仅供参考。如有疑问，请向本公司查询。
 Information above just for your reference. Please contact us if you have any questions, Thank you!

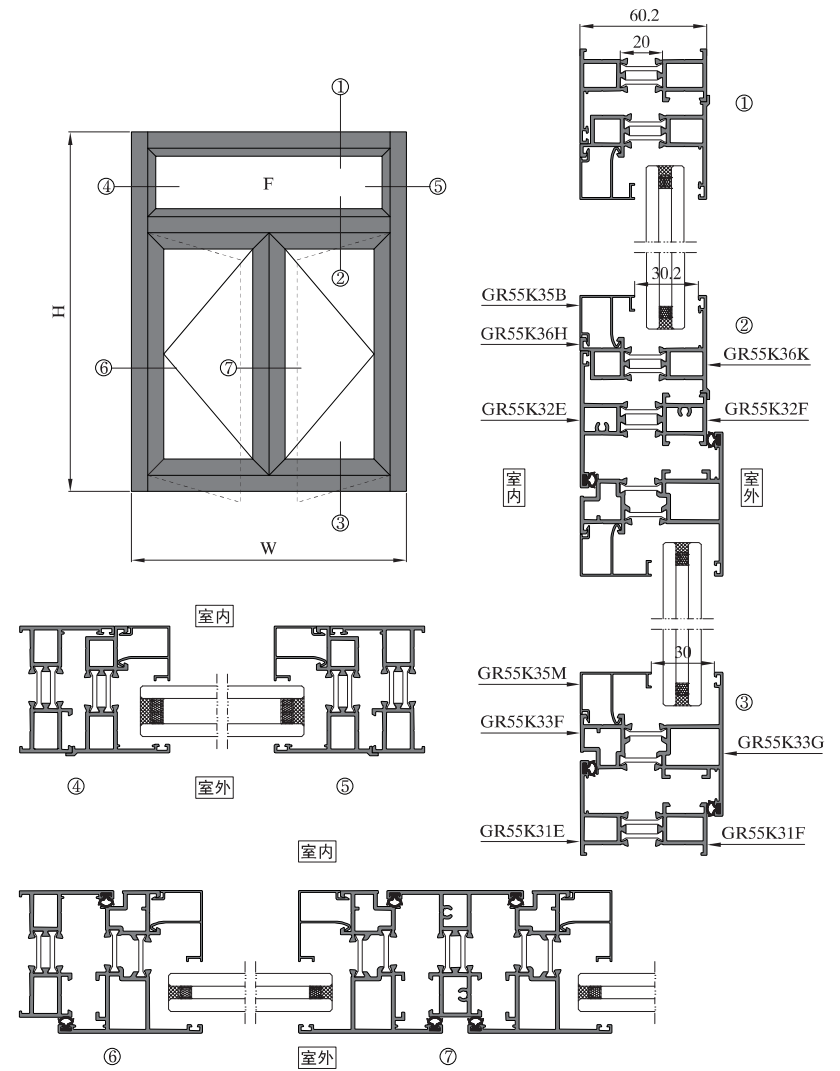
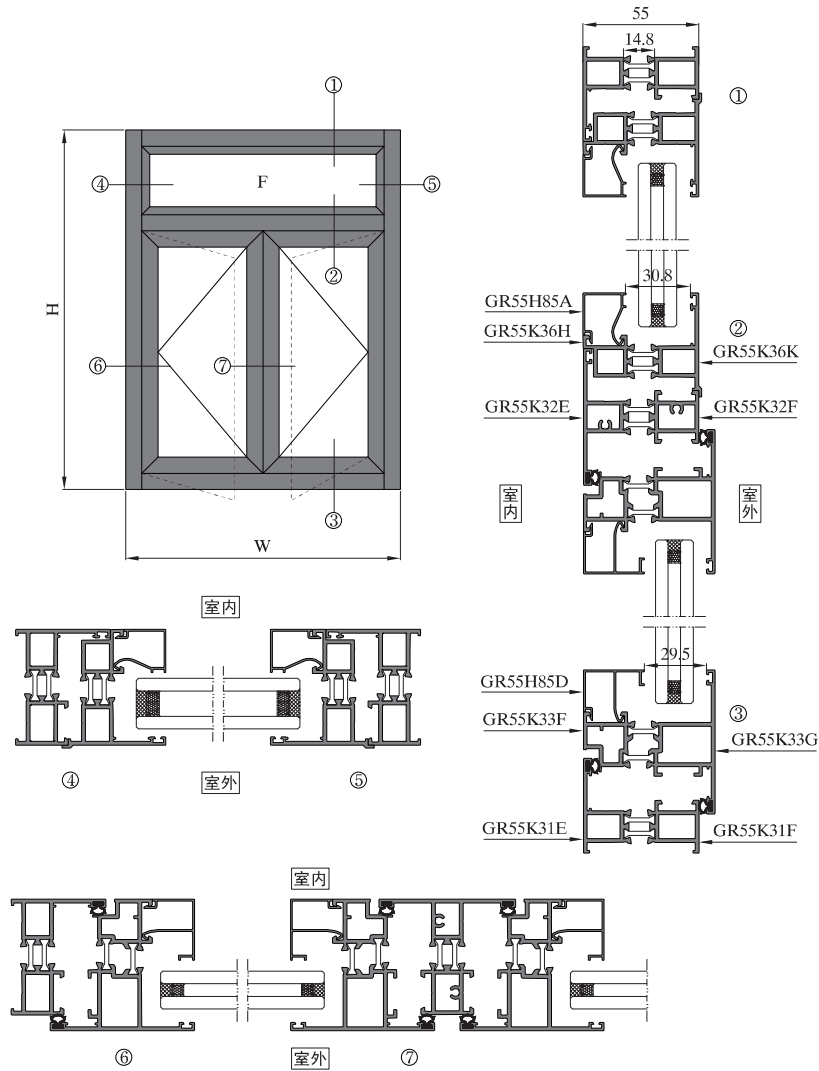

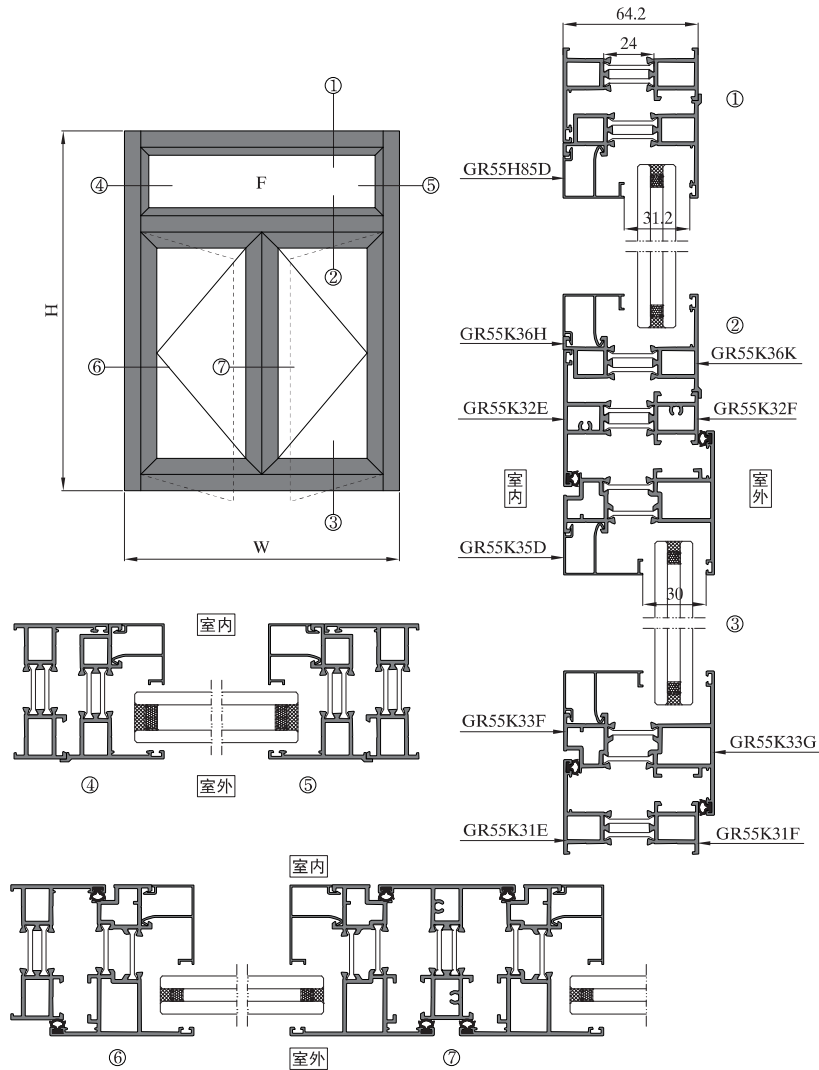

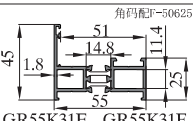
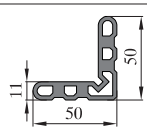
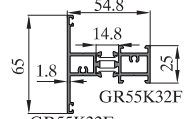
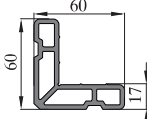
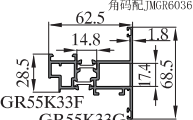
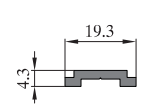
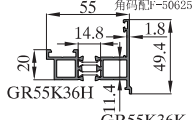
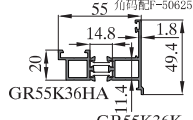
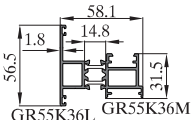
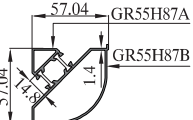
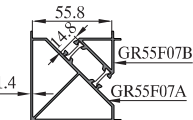
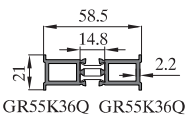
序号 S/N	型号理论重量 JMA Code & KG/M	型材图 Drawing	序号 S/N	型号理论重量 JMA Code & KG/M	型材图 Drawing	序号 S/N	型号理论重量 JMA Code & KG/M	型材图 Drawing
1	窗框 GR55K31E GR55K31F T=1.8 1.158kg/m		10	角码 F-50625 T=2.5 1.786kg/m		19		
2	窗中挺 GR55K32E GR55K32F T=1.8 1.376kg/m		11	角码 JMGR6036 T=3.0 2.278kg/m		20		
3	窗扇 GR55K33F GR55K33G T=1.8 1.549kg/m		12	传动杆 JMGR5507A 0.153kg/m		21		
4	转换框 GR55K36H GR55K36K T=1.8 1.123kg/m		13			22		
5	转换框 GR55K36HA GR55K36K T=1.8 1.093kg/m		14			23		
6	假中挺 GR55K36L GR55K36M T=1.8 1.395kg/m		15			24		
7	转角 GR55H87A GR55H87B T=1.4 1.322kg/m		16			25		
8	转角 GR55F07A GR55F07B T=1.4 1.690kg/m		17			26		
9	拼管 GR55K36Q GR55K36Q T=2.2 1.099kg/m		18			27		

序号 S/N	型号理论重量 JMA Code & KG/M	型材图 Drawing	序号 S/N	型号理论重量 JMA Code & KG/M	型材图 Drawing	序号 S/N	型号理论重量 JMA Code & KG/M	型材图 Drawing
1	窗框 GR55K31E GR55K31F T=1.8 1.184kg/m		10	角码 JMGR6036 T=3.0 2.278kg/m		19		
2	窗中挺 GR55K32E GR55K32F T=1.8 1.402kg/m		11	传动杆 JMGR5507A 0.153kg/m		20		
3	窗扇 GR55K33F GR55K33G T=1.8 1.575kg/m		12			21		
4	转换框 GR55K36H GR55K36K T=1.8 1.149kg/m		13			22		
5	转换框 GR55K36HA GR55K36K T=1.8 1.119kg/m		14			23		
6	转角 GR60D44A GR60D44B T=1.5 1.898kg/m		15			24		
7	假中挺 GR55K36L GR55K36M T=1.8 1.421kg/m		16			25		
8	拼管 GR55K36Q GR55K36Q T=2.2 1.125kg/m		17			26		
9	角码 F-50625 T=2.5 1.786kg/m		18			27		

序号 S/N	型号理论重量 JMA Code & KG/M	型材图 Drawing	序号 S/N	型号理论重量 JMA Code & KG/M	型材图 Drawing	序号 S/N	型号理论重量 JMA Code & KG/M	型材图 Drawing
1	窗框 GR55K31E GR55K31F T=1.8 1.214kg/m		10	角码 JMGR6036 T=3.0 2.278kg/m		19		
2	窗中挺 GR55K32E GR55K32F T=1.8 1.432kg/m		11	传动杆 JMGR5507A 0.153kg/m		20		
3	窗扇 GR55K33F GR55K33G T=1.8 1.605kg/m		12			21		
4	转换框 GR55K36H GR55K36K T=1.8 1.179kg/m		13			22		
5	转换框 GR55K36HA GR55K36K T=1.8 1.149kg/m		14			23		
6	转角 GR55K36N GR55K36P T=1.8 1.851kg/m		15			24		
7	假中挺 GR55K36L GR55K36M T=1.8 1.452kg/m		16			25		
8	拼管 GR55K36Q GR55K36Q T=2.2 1.156kg/m		17			26		
9	角码 F-50625 T=2.5 1.786kg/m		18			27		

图中所示型材截面、装配、编号、尺寸及重量仅供参考。如有疑问，请向本公司查询。
 Information above just for your reference. Please contact us if you have any questions, Thank you!

图中所示型材截面、装配、编号、尺寸及重量仅供参考。如有疑问，请向本公司查询。
 Information above just for your reference. Please contact us if you have any questions, Thank you!

序号 S/N	型号理论重量 JMA Code & KG/M	型材图 Drawing	序号 S/N	型号理论重量 JMA Code & KG/M	型材图 Drawing	序号 S/N	型号理论重量 JMA Code & KG/M	型材图 Drawing
1	框压线 GR55K35A T=0.9 0.222kg/m		10	框压线 GR55H85A T=0.9 0.206kg/m		19		
2	框压线 GR55K35B T=0.9 0.235kg/m		11	框压线 GR55H85B T=0.9 0.187kg/m		20		
3	框压线 GR55K35C T=0.9 0.335kg/m		12	框压线 GR55H85C T=0.9 0.228kg/m		21		
4	框压线 GR55K35D T=0.9 0.266kg/m		13	框压线 GR55H85D T=0.9 0.243kg/m		22		
5	框压线 GR55K35E T=0.9 0.253kg/m		14	框压线 GR55H85E T=0.9 0.311kg/m		23		
6	框压线 GR55K35F T=0.9 0.246kg/m		15			24		
7	框压线 GR55K35G T=0.9 0.235kg/m		16			25		
8	框压线 GR55K35K T=0.9 0.201kg/m		17			26		
9	框压线 GR55K35M T=0.9 0.256kg/m		18			27		

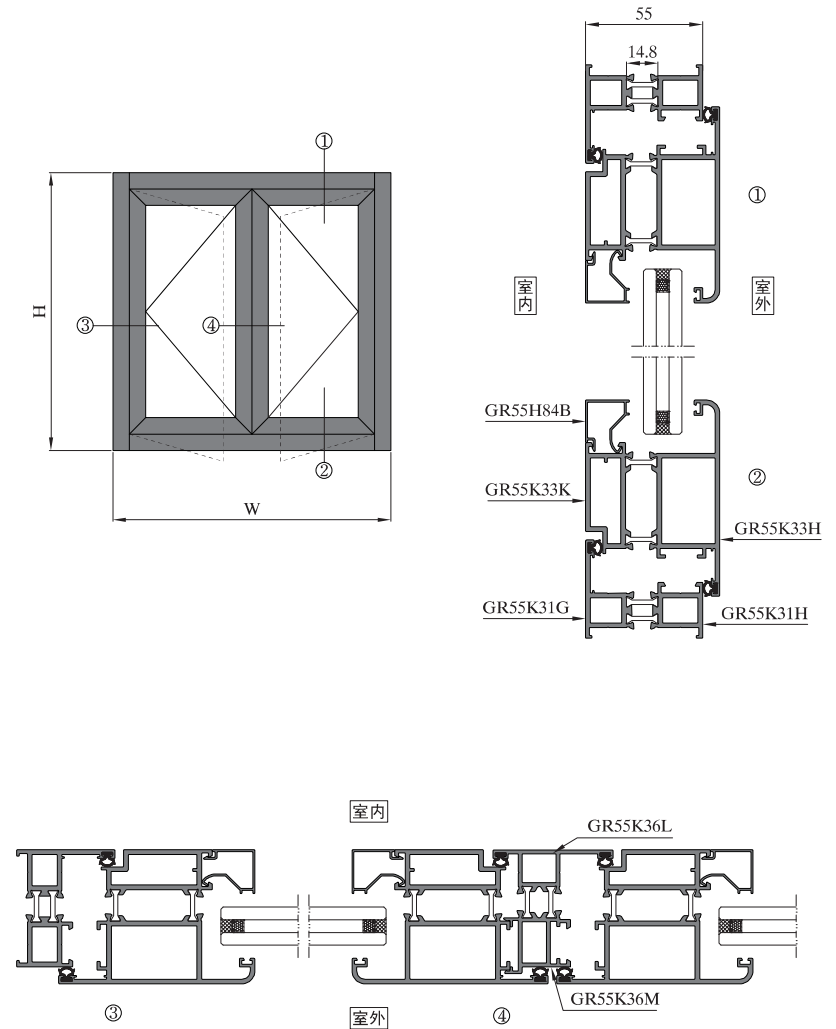

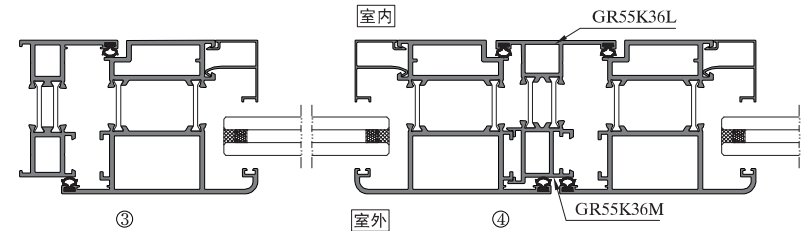
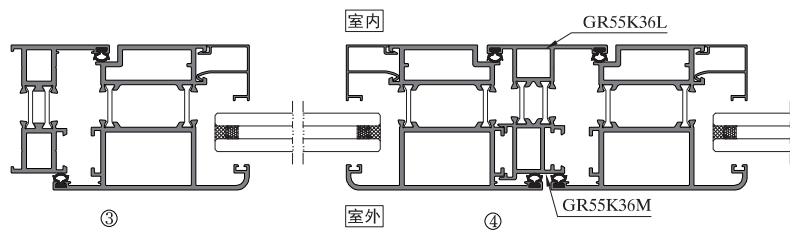
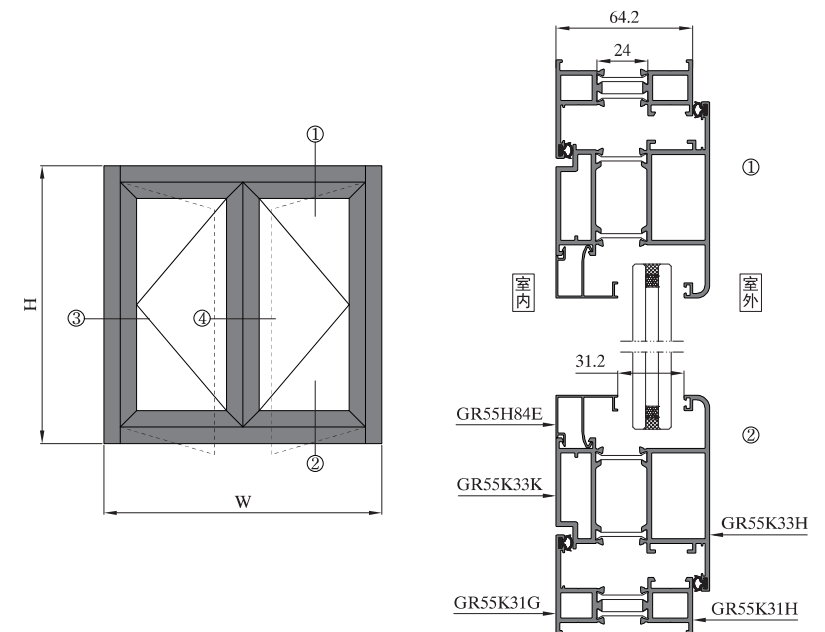
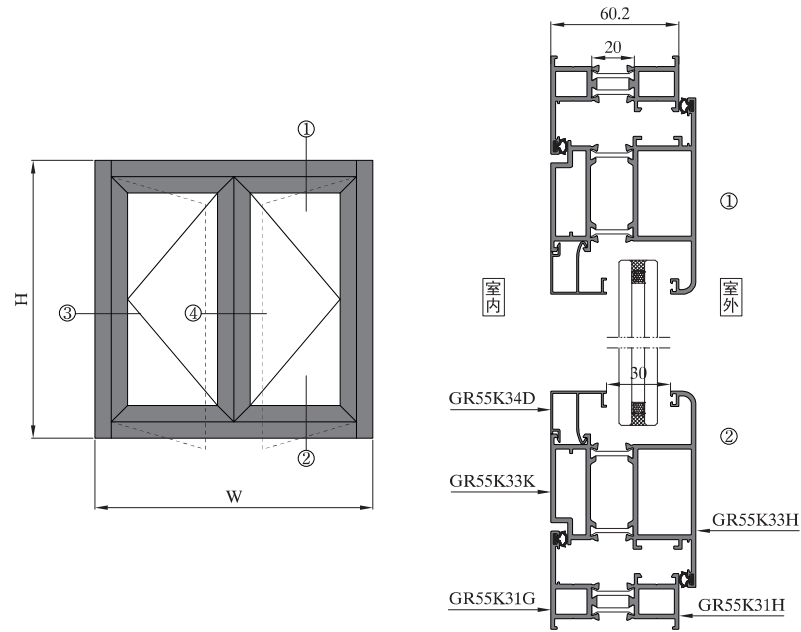

序号 S/N	型号理论重量 JMA Code & KG/M	型材图 Drawing	序号 S/N	型号理论重量 JMA Code & KG/M	型材图 Drawing	序号 S/N	型号理论重量 JMA Code & KG/M	型材图 Drawing
1	门框 GR55K31G GR55K31H T=2.2 1.353kg/m		10	角码 F-50625 T=2.5 1.786kg/m		19		
2	窗中挺 GR55K32E GR55K32F T=1.8 1.376kg/m		11	角码 GR50A18 2.649kg/m		20		
3	门扇 GR55K33K GR55K33H T=2.2 2.438kg/m		12	角码 JMGR7535A T=3.5 4.996kg/m		21		
4	转换框 GR55K36H GR55K36K T=1.8 1.123kg/m		13	传动杆 JMGR5507A 0.153kg/m		22		
5	转换框 GR55K36HA GR55K36K T=1.8 1.093kg/m		14			23		
6	假中挺 GR55K36L GR55K36M T=1.8 1.395kg/m		15			24		
7	转角 GR55H87A GR55H87B T=1.4 1.322kg/m		16			25		
8	转角 GR55F07A GR55F07B T=1.4 1.690kg/m		17			26		
9	拼管 GR55K36Q GR55K36Q T=2.2 1.099kg/m		18			27		

序号 S/N	型号理论重量 JMA Code & KG/M	型材图 Drawing	序号 S/N	型号理论重量 JMA Code & KG/M	型材图 Drawing	序号 S/N	型号理论重量 JMA Code & KG/M	型材图 Drawing
1	门框 GR55K31G GR55K31H T=2.2 1.379kg/m		10	角码 JMGR6036 T=3.0 2.278kg/m		19		
2	窗中挺 GR55K32E GR55K32F T=1.8 1.402kg/m		11	角码 GR50A18 2.649kg/m		20		
3	门扇 GR55K33K GR55K33H T=2.2 2.463kg/m		12	角码 JMGR7535A T=3.5 4.996kg/m		21		
4	转换框 GR55K36H GR55K36K T=1.8 1.149kg/m		13	传动杆 JMGR5507A 0.153kg/m		22		
5	转换框 GR55K36HA GR55K36K T=1.8 1.119kg/m		14			23		
6	转角 GR60D44A GR60D44B T=1.5 1.898kg/m		15			24		
7	假中挺 GR55K36L GR55K36M T=1.8 1.421kg/m		16			25		
8	拼管 GR55K36Q GR55K36Q T=2.2 1.125kg/m		17			26		
9	角码 F-50625 T=2.5 1.786kg/m		18			27		

序号 S/N	型号理论重量 JMA Code & KG/M	型材图 Drawing	序号 S/N	型号理论重量 JMA Code & KG/M	型材图 Drawing	序号 S/N	型号理论重量 JMA Code & KG/M	型材图 Drawing
1	门框 GR55K31G GR55K31H T=2.2 1.409kg/m		10	角码 JMGR6036 T=3.0 2.278kg/m		19		
2	窗中挺 GR55K32E GR55K32F T=1.8 1.432kg/m		11	角码 GR50A18 2.649kg/m		20		
3	门扇 GR55K33K GR55K33H T=2.2 2.494kg/m		12	角码 JMGR7535A T=3.5 4.996kg/m		21		
4	转换框 GR55K36H GR55K36K T=1.8 1.179kg/m		13	传动杆 JMGR5507A 0.153kg/m		22		
5	转换框 GR55K36HA GR55K36K T=1.8 1.149kg/m		14			23		
6	转角 GR55K36N GR55K36P T=1.8 1.851kg/m		15			24		
7	假中挺 GR55K36L GR55K36M T=1.8 1.452kg/m		16			25		
8	拼管 GR55K36Q GR55K36Q T=2.2 1.156kg/m		17			26		
9	角码 F-50625 T=2.5 1.786kg/m		18			27		

序号 S/N	型号理论重量 JMA Code & KG/M	型材图 Drawing	序号 S/N	型号理论重量 JMA Code & KG/M	型材图 Drawing	序号 S/N	型号理论重量 JMA Code & KG/M	型材图 Drawing
1	扇压线 GR55K34D T=0.9 0.235kg/m		10	框压线 GR55K35E T=0.9 0.253kg/m		19	框压线 GR55H85E T=0.9 0.311kg/m	
2	扇压线 GR55K34F T=0.9 0.217kg/m		11	框压线 GR55K35F T=0.9 0.246kg/m		20		
3	扇压线 GR55H84B T=0.9 0.212kg/m		12	框压线 GR55K35G T=0.9 0.235kg/m		21		
4	扇压线 GR55H84E T=0.9 0.243kg/m		13	框压线 GR55K35K T=0.9 0.201kg/m		22		
5	扇压线 GR55H84F T=0.9 0.227kg/m		14	框压线 GR55K35M T=0.9 0.256kg/m		23		
6	框压线 GR55K35A T=0.9 0.222kg/m		15	框压线 GR55H85A T=0.9 0.206kg/m		24		
7	框压线 GR55K35B T=0.9 0.235kg/m		16	框压线 GR55H85B T=0.9 0.187kg/m		25		
8	框压线 GR55K35C T=0.9 0.335kg/m		17	框压线 GR55H85C T=0.9 0.228kg/m		26		
9	框压线 GR55K35D T=0.9 0.266kg/m		18	框压线 GR55H85D T=0.9 0.243kg/m		27		

图中所示型材截面、装配、编号、尺寸及重量仅供参考。如有疑问，请向本公司查询。
 Information above just for your reference. Please contact us if you have any questions, Thank you!

图中所示型材截面、装配、编号、尺寸及重量仅供参考。如有疑问，请向本公司查询。
 Information above just for your reference. Please contact us if you have any questions, Thank you!

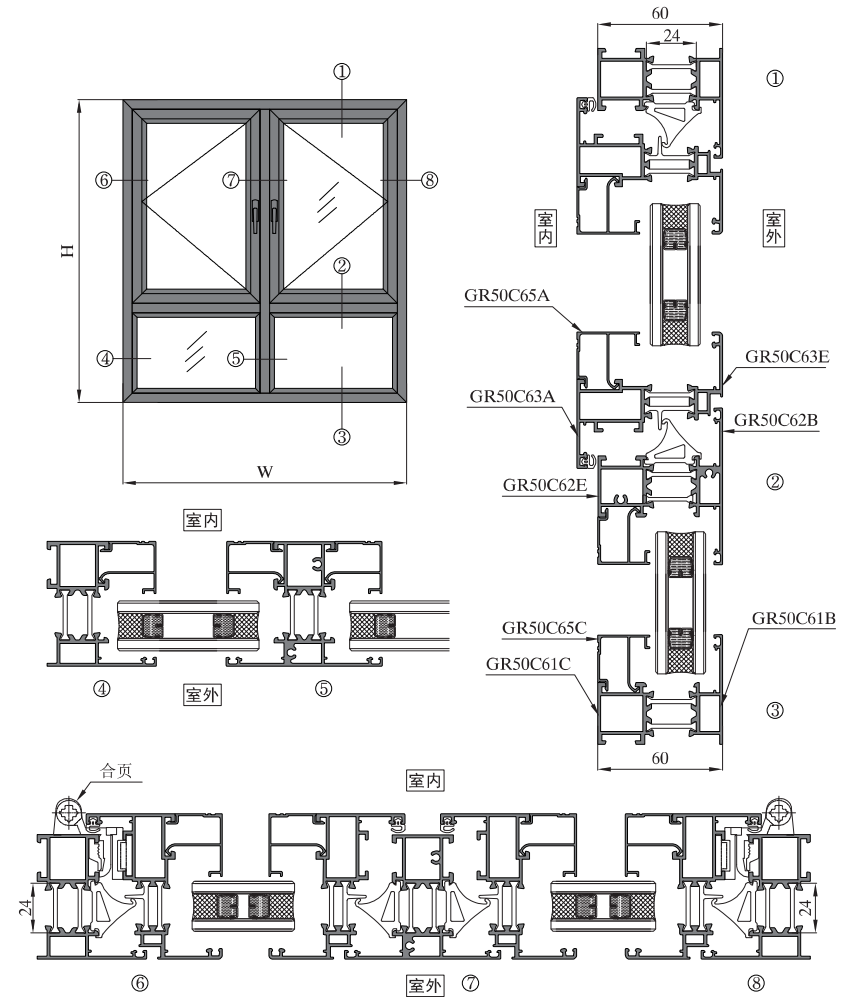
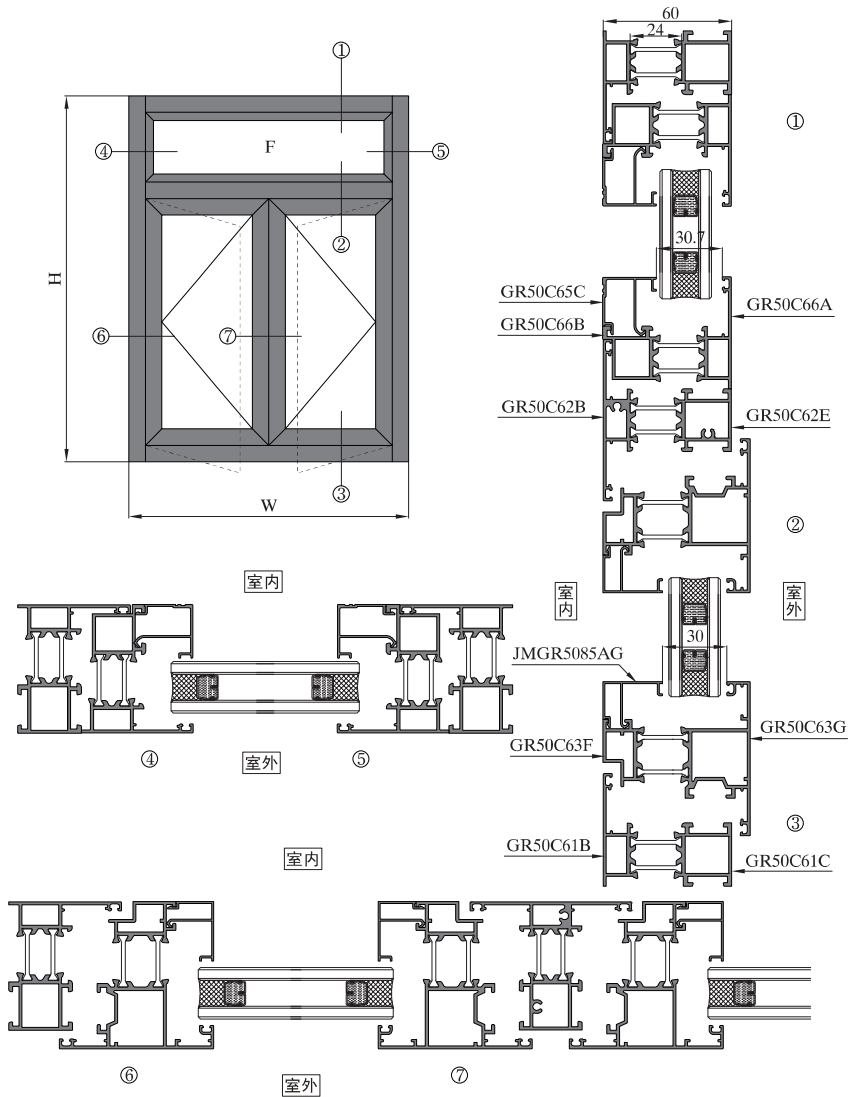

序号 S/N	型号理论重量 JMA Code & KG/M	型材图 Drawing	序号 S/N	型号理论重量 JMA Code & KG/M	型材图 Drawing	序号 S/N	型号理论重量 JMA Code & KG/M	型材图 Drawing
1	JMGR63A12 JMGR63A12 2.722kg/m		10	JMGR6379B 0.184kg/m		19		
2	JMGR63A12A JMGR63A12A 2.953kg/m		11	JMGR6378A 0.140kg/m		20		
3	JMGR63A13 JMGR63A13 2.211kg/m		12	JM100320 0.281kg/m		21		
4	JMGR63A13A JMGR63A13A 2.375kg/m		13			22		
5	JMGR63A14 JMGR63A14 1.947kg/m		14			23		
6	JMGR63A14A JMGR63A14A 2.085kg/m		15			24		
7	JMGR63A15 JMGR63A15 2.213kg/m		16			25		
8	JMGR63A15A JMGR63A15A 2.377kg/m		17			26		
9	JMGR6379E 0.193kg/m		18			27		

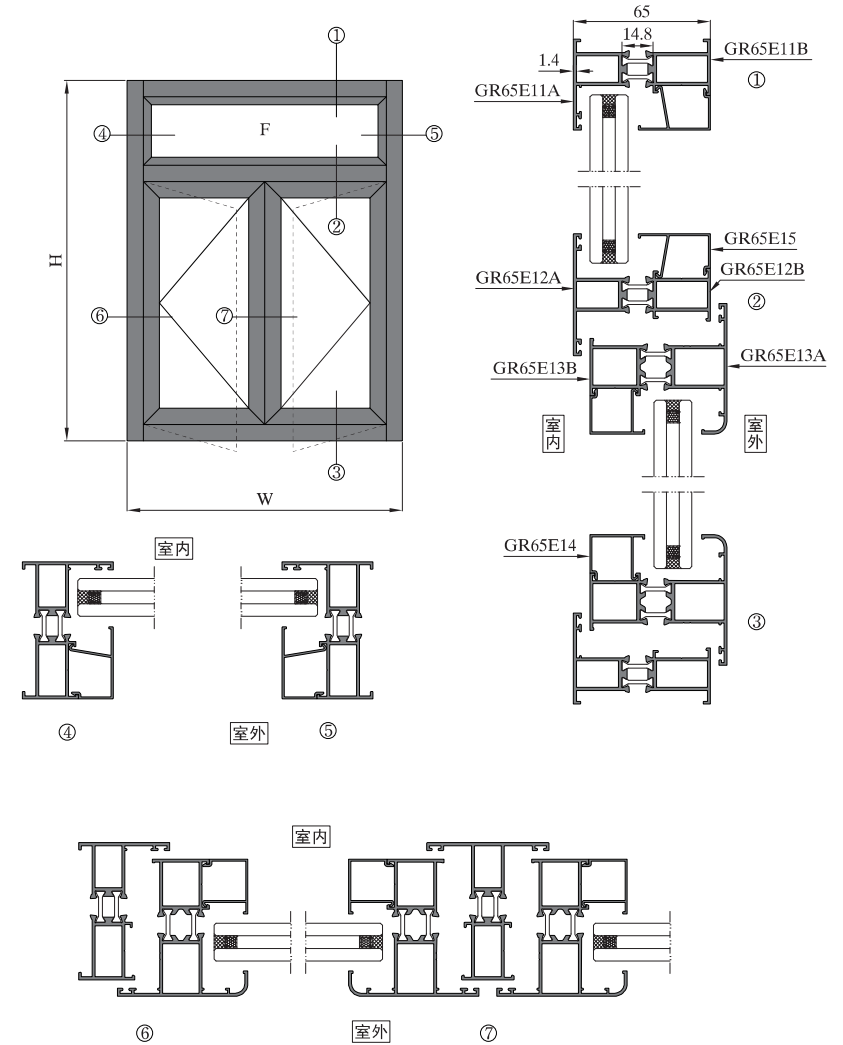

序号 S/N	型号理论重量 JMA Code & KG/M	型材图 Drawing	序号 S/N	型号理论重量 JMA Code & KG/M	型材图 Drawing	序号 S/N	型号理论重量 JMA Code & KG/M	型材图 Drawing
1	框料 GR65E11A GR65E11B 1.091kg/m		10	槽铝 JM203720 0.432kg/m		19		
2	中挺 GR65E12A GR65E12B 1.166kg/m		11	隔热转角 GR65A05 JMGR50B15D 1.578kg/m		20		
3	扇料 GR65E13A GR65E13B 1.261kg/m		12			21		
4	压线 GR65E14 0.213kg/m		13			22		
5	压线 GR65E15 0.230kg/m		14			23		
6	压线 GR65E15A 0.239kg/m		15			24		
7	中挺 GR65E16C GR65E16D 1.194kg/m		16			25		
8	角码 JM5004A 2.354kg/m		17			26		
9	角码 JMGR6036 2.278kg/m		18			27		

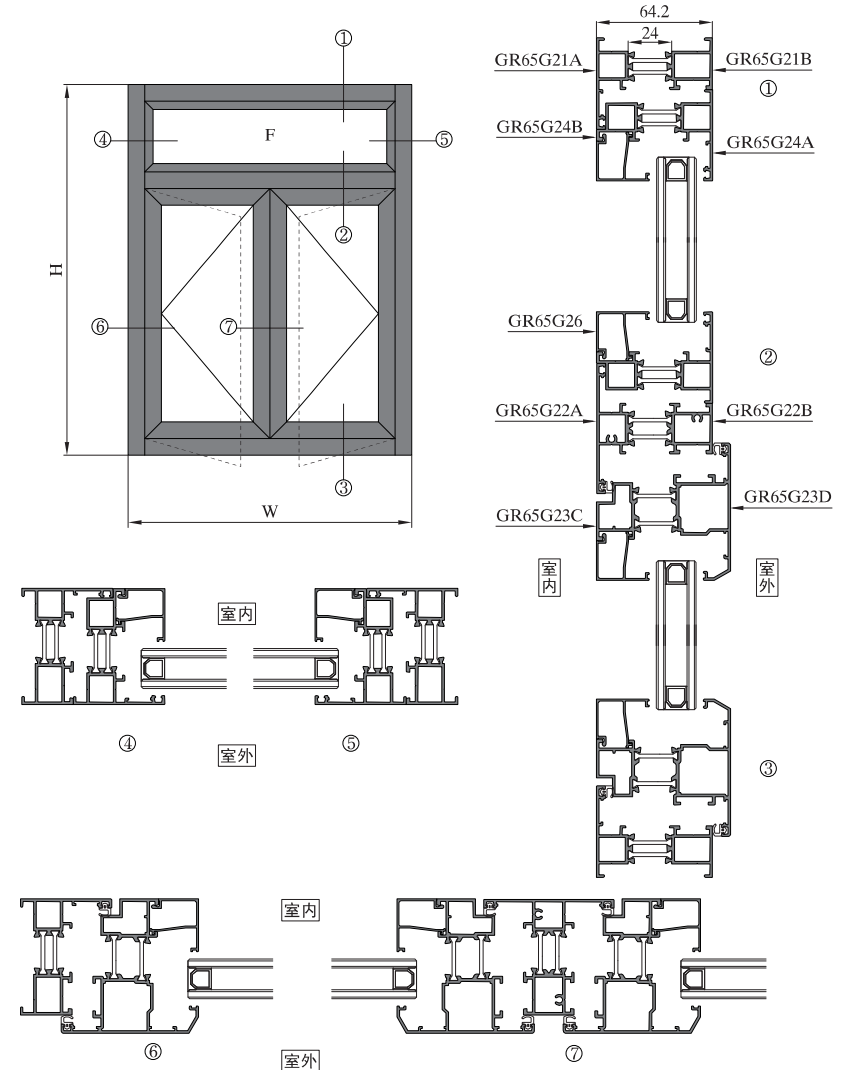

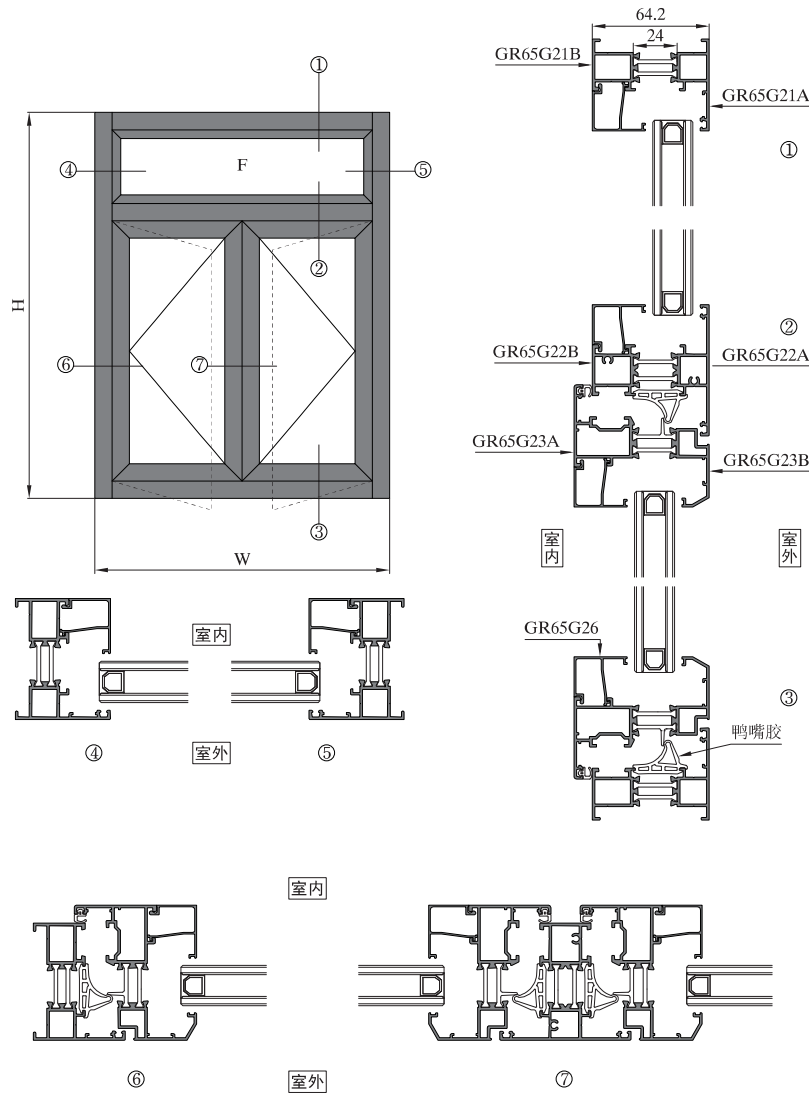

序号 S/N	型号理论重量 JMA Code & KG/M	型材图 Drawing	序号 S/N	型号理论重量 JMA Code & KG/M	型材图 Drawing	序号 S/N	型号理论重量 JMA Code & KG/M	型材图 Drawing
1	框料 GR65G21A GR65G21B 1.183kg/m	角码配GR65G29A GR65G21A GR65G21B	10	压线 GR65G26B 0.226kg/m	玻璃槽口45mm	19		
2	中挺 GR65G22A GR65G22B 1.450kg/m	GR65G22A GR65G22B	11	转角 GR65G27A GR65G27B 1.521kg/m	GR65G27B GR65G27A	20		
3	加强中挺 GR65G22B GR65G22C 1.847kg/m	GR65G22C GR65G22B	12	拼管 GR65G28 GR65G28 0.987kg/m	GR65G28	21		
4	内开扇 GR65G23A GR65G23B 1.417kg/m	角码配GR65G29A GR65G23A GR65G23B	13	角码 GR65G29 2.533kg/m	GR65G29	22		
5	外开扇 GR65G23C GR65G23D 1.590kg/m	角码配GR65G29 GR65G23C GR65G23D	14	角码 GR65G29A 2.448kg/m	GR65G29A	23		
6	转换框 GR65G24A GR65G24B 1.119kg/m	角码配GR65G29A GR65G24A GR65G24B	15			24		
7	假中挺 GR65G25A GR65G25B 1.369kg/m	GR65G25A GR65G25B	16			25		
8	压线 GR65G26 0.275kg/m	玻璃槽口30mm	17			26		
9	压线 GR65G26A 0.262kg/m	玻璃槽口34.2mm	18			27		

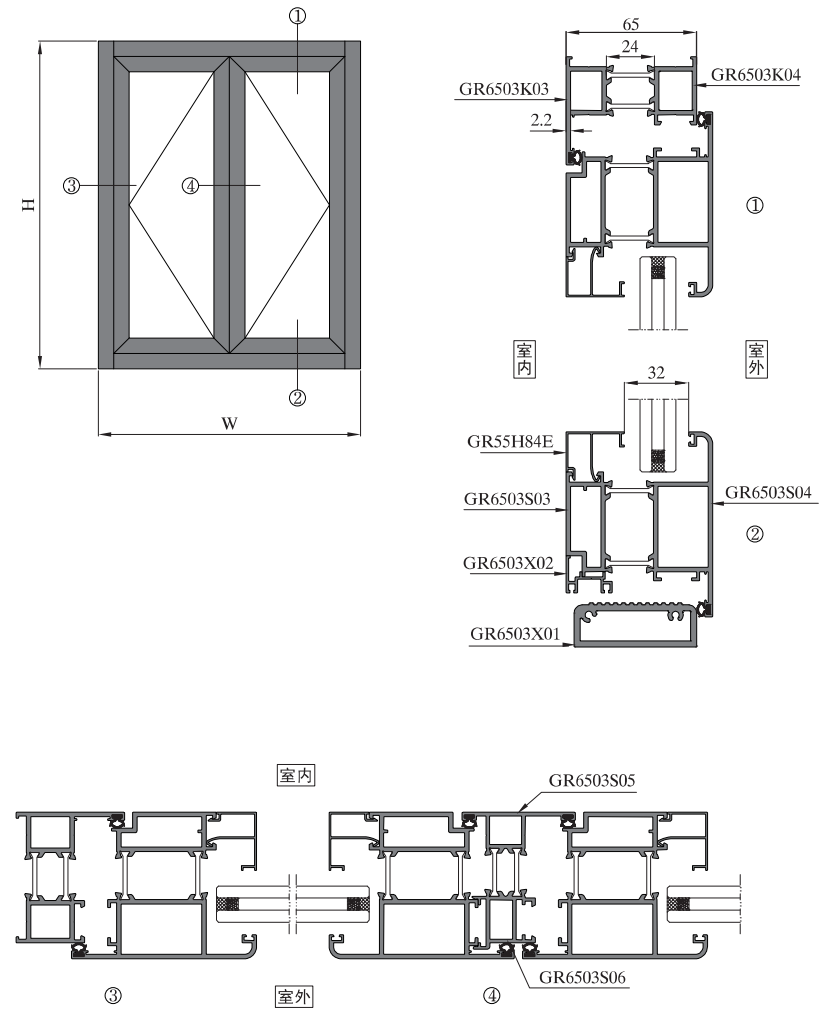
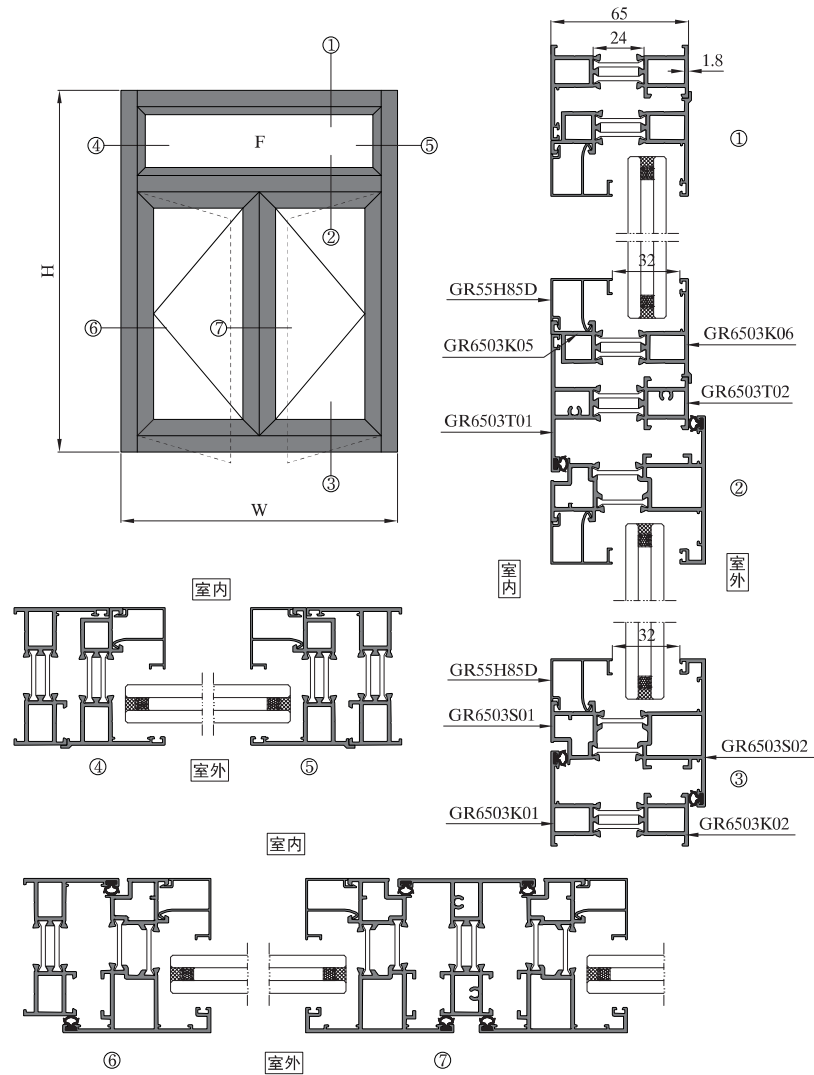

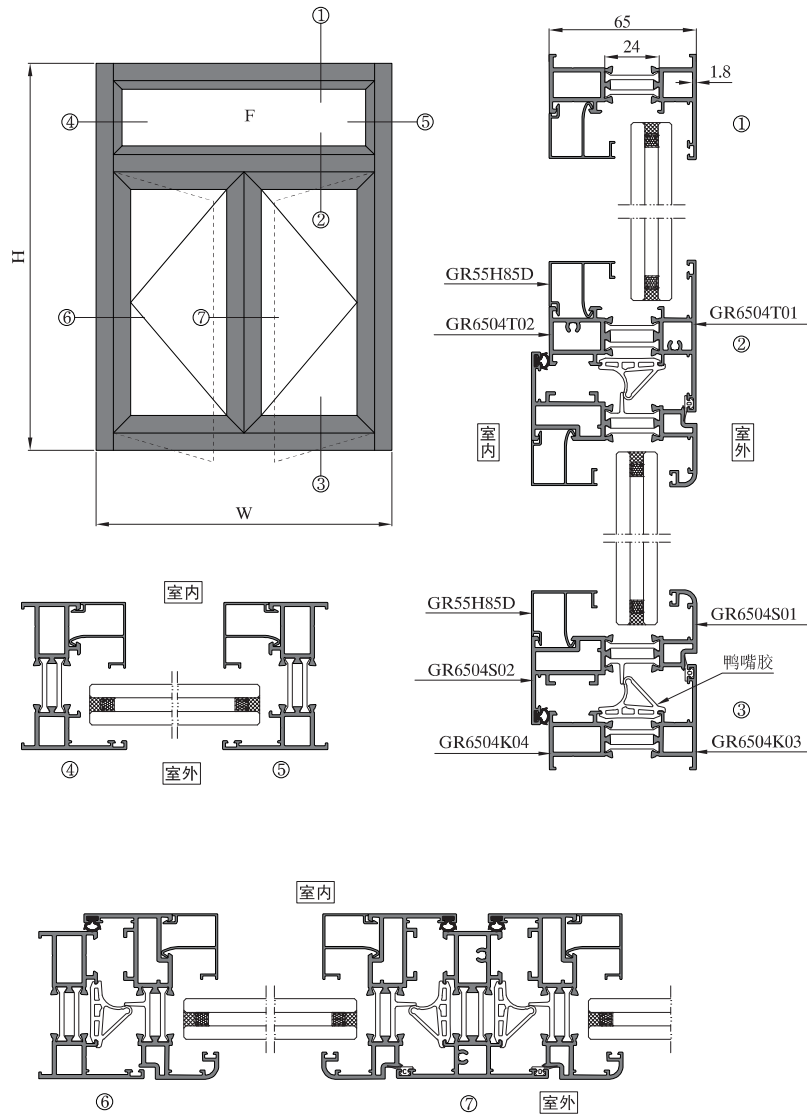

序号 S/N	型号理论重量 JMA Code & KG/M	型材图 Drawing	序号 S/N	型号理论重量 JMA Code & KG/M	型材图 Drawing	序号 S/N	型号理论重量 JMA Code & KG/M	型材图 Drawing
1	框料 GR6504K01 GR6504K02 T=1.8 1.420kg/m	角码配JMGR6036 65 1.8 24 1.8 52.5 17.4 7.4 1.8 5.2	10	框扇压线 GR55K35B T=0.9 0.235kg/m	玻璃开口35mm 26 0.9 20 16.3	19	框扇压线 GR55H85B T=0.9 0.187kg/m	玻璃开口49mm 0.9 12 20 16.3
2	框料 GR6504K03 GR6504K04 T=1.8 1.267kg/m	角码配F-50625 65 1.8 24 1.8 46.5 1.4 1.8 24 1.8 2.0	11	框扇压线 GR55K35C T=0.9 0.335kg/m	玻璃开口15.3mm 55.7 0.9 20 16.3	20	框扇压线 GR55H85C T=0.9 0.228kg/m	玻璃开口38mm 0.9 23 20 16.3
3	中挺 GR6504T01 GR6504T02 T=1.8 1.549kg/m	64.8 1.8 24 1.8 67 1.8 2.0	12	框扇压线 GR55K35D T=0.9 0.266kg/m	玻璃开口23.3mm 0.9 37.7 20 16.3	21	框扇压线 GR55H85D T=0.9 0.243kg/m	玻璃开口32mm 0.9 29 20 16.3
4	加强中挺 GR6504T02 GR6504T03 T=1.8 2.141kg/m	109 1.8 64.8 24 1.8 2.0 67 1.8 2.0	13	框扇压线 GR55K35E T=0.9 0.253kg/m	玻璃开口28.3mm 0.9 32.7 20 16.3	22	框扇压线 GR55H85E T=0.9 0.311kg/m	玻璃开口12.8mm 0.9 48.2 20 16.3
5	扇料 GR6504S01 GR6504S02 T=1.8 1.504kg/m	角码配PC3855A 73 1.8 24 1.8 50.5 30	14	框扇压线 GR55K35F T=0.9 0.246kg/m	玻璃开口30.8mm 0.9 30.2 20 16.3	23		
6	角码 F-50625 T=2.5 1.786kg/m	50 50 11	15	框扇压线 GR55K35G T=0.9 0.235kg/m	玻璃开口134.8mm 0.9 26.2 20 16.3	24		
7	角码 JMGR6036 T=3.0 2.278kg/m	60 60 17	16	框扇压线 GR55K35K T=0.9 0.201kg/m	玻璃开口41.8mm 0.9 19.2 20 16.3	25		
8	角码 PC3855A T=5.1 1.307kg/m	41.91 41.91 8.1	17	框扇压线 GR55K35M T=0.9 0.256kg/m	玻璃开口27.3mm 0.9 33.7 20 16.3	26		
9	框扇压线 GR55K35A T=0.9 0.222kg/m	玻璃开口40mm 21 0.9 20 16.3	18	框扇压线 GR55H85A T=0.9 0.206kg/m	玻璃开口40.5mm 0.9 20.5 20 16.3	27		

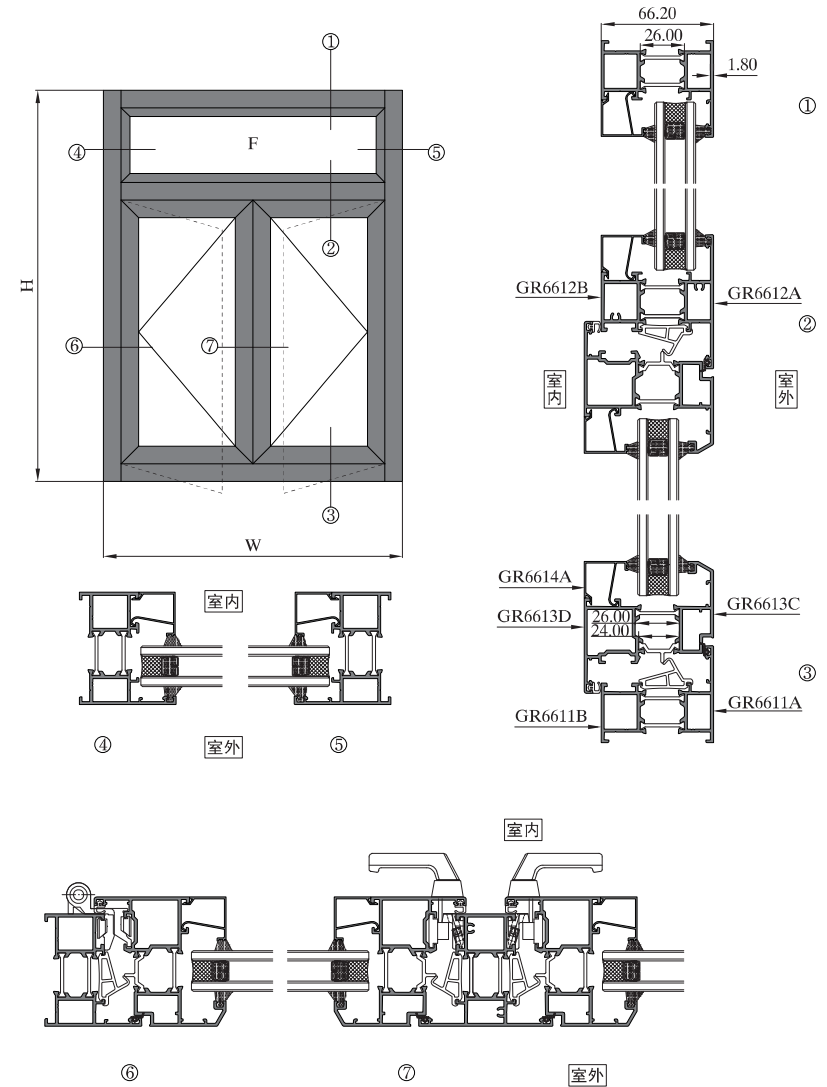
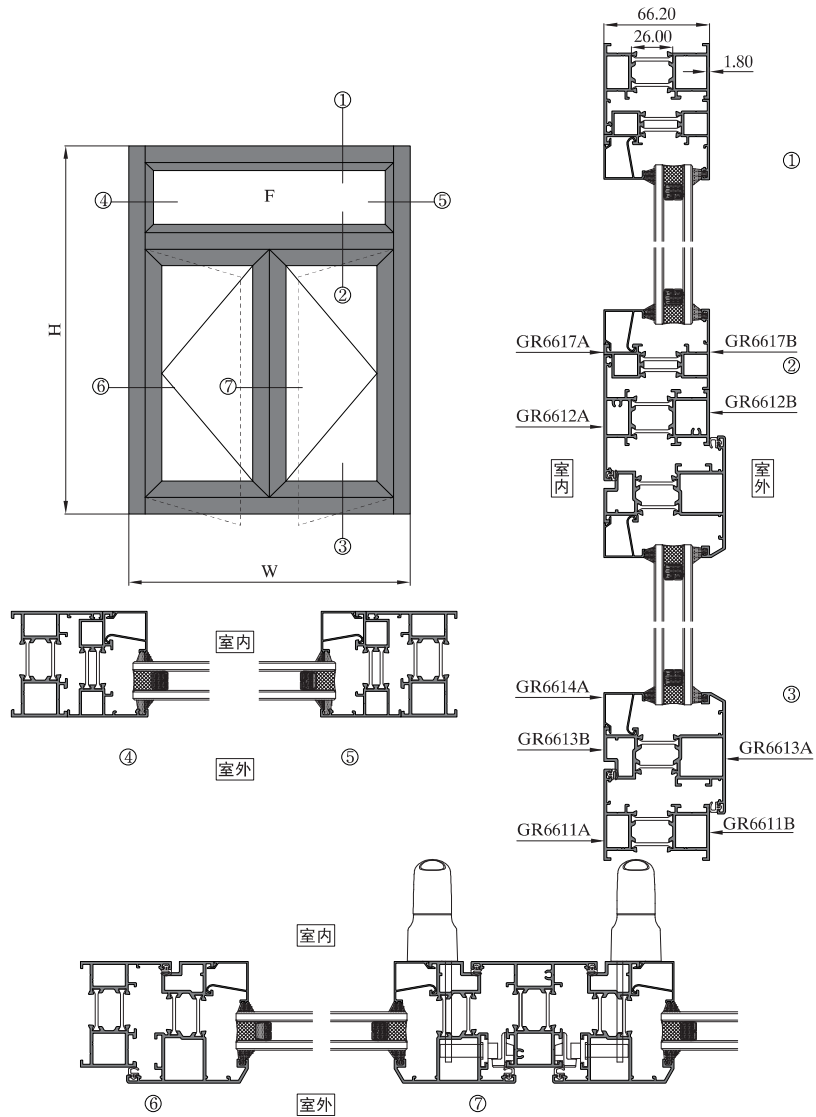

序号 S/N	型号理论重量 JMA Code & KG/M	型材图 Drawing	序号 S/N	型号理论重量 JMA Code & KG/M	型材图 Drawing	序号 S/N	型号理论重量 JMA Code & KG/M	型材图 Drawing
1	框料 GR6611A GR6611B 1.554kg/m		10			19		
2	中挺 GR6612A GR6612B 1.814kg/m		11			20		
3	外开扇 GR6613A GR6613B 1.887kg/m		12			21		
4	内开扇 GR6613C GR6613D 1.940kg/m		13			22		
5	转换料 GR6617A GR6617B 1.151kg/m		14			23		
6	压线 GR6614A 0.241kg/m		15			24		
7	压线 GR6614B 0.260kg/m		16			25		
8			17			26		
9			18			27		

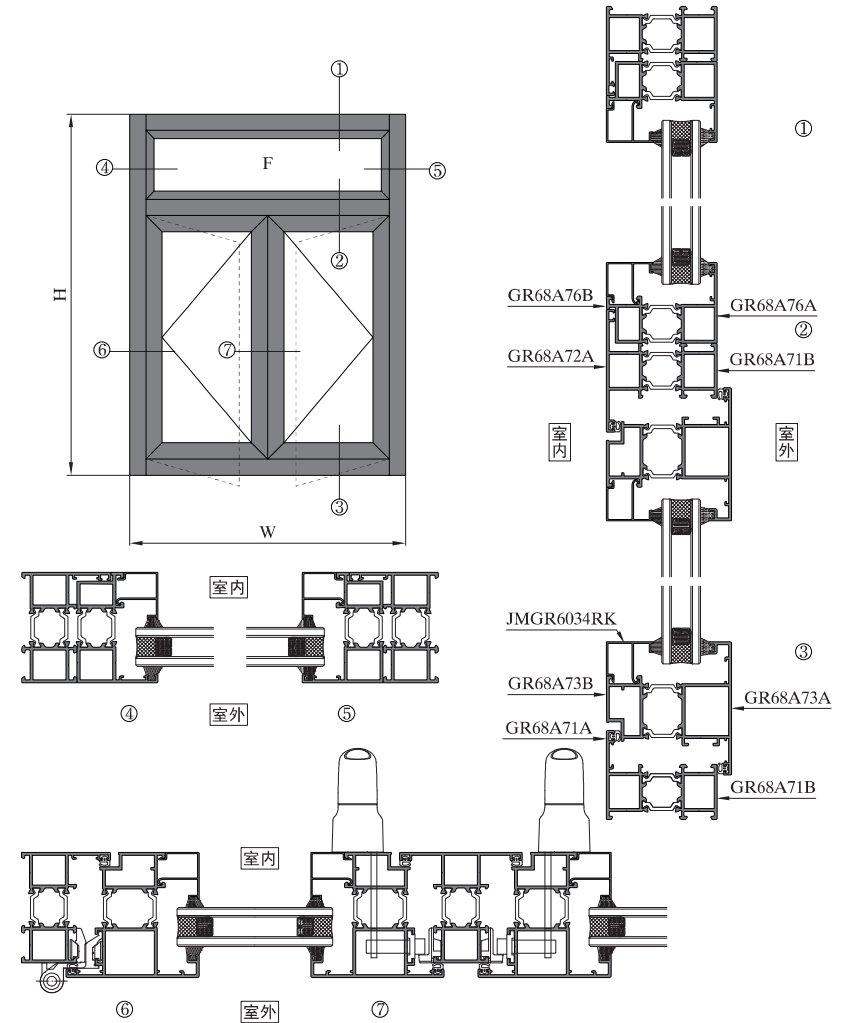

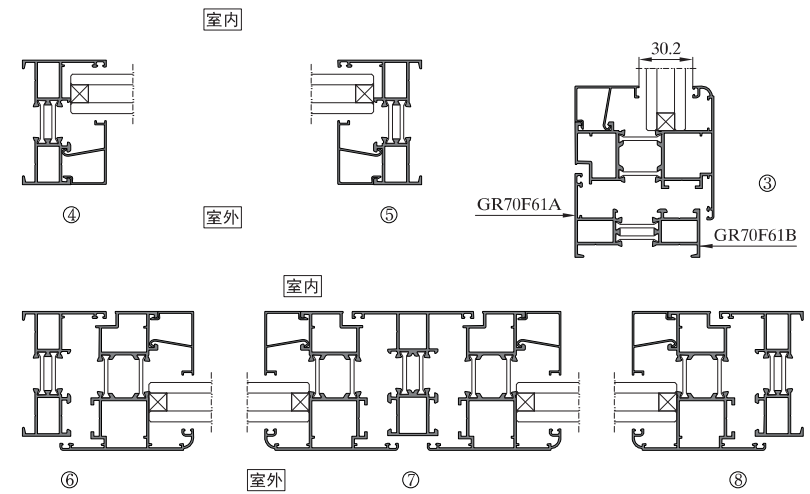
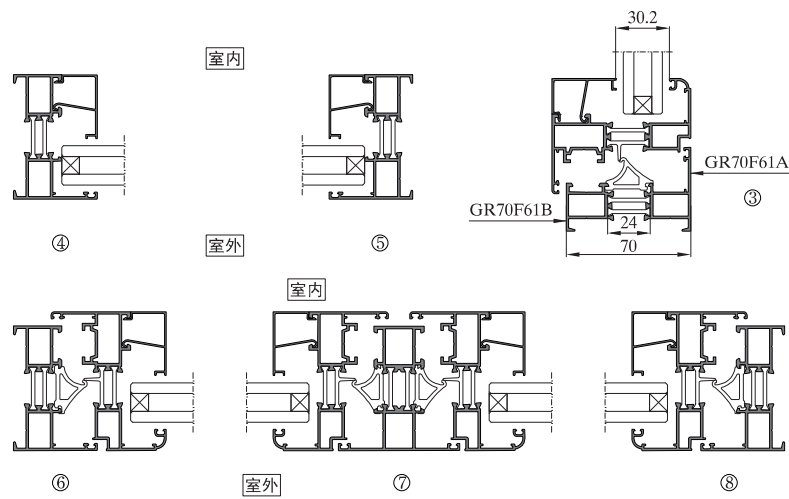
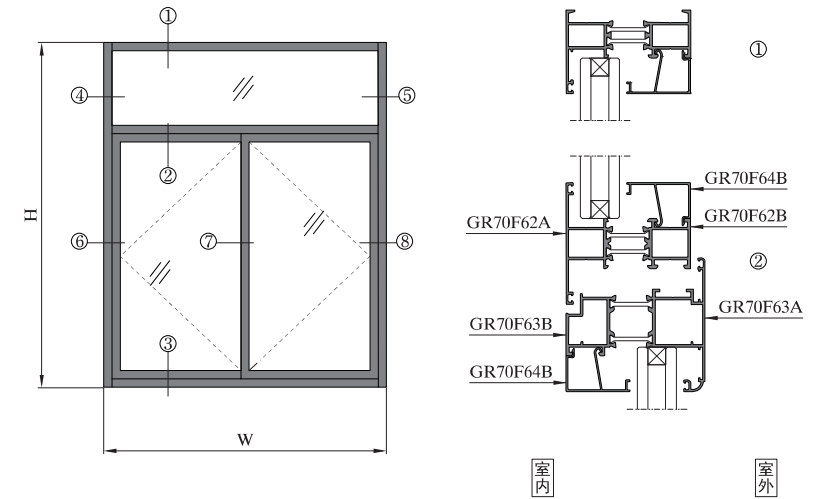
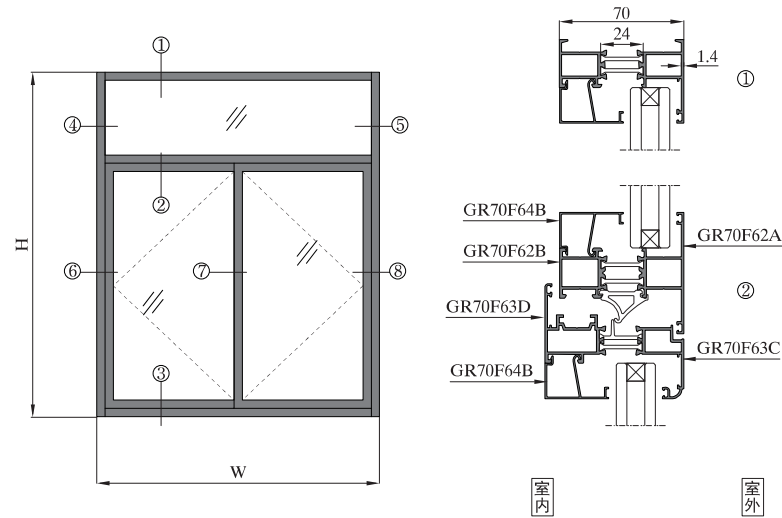



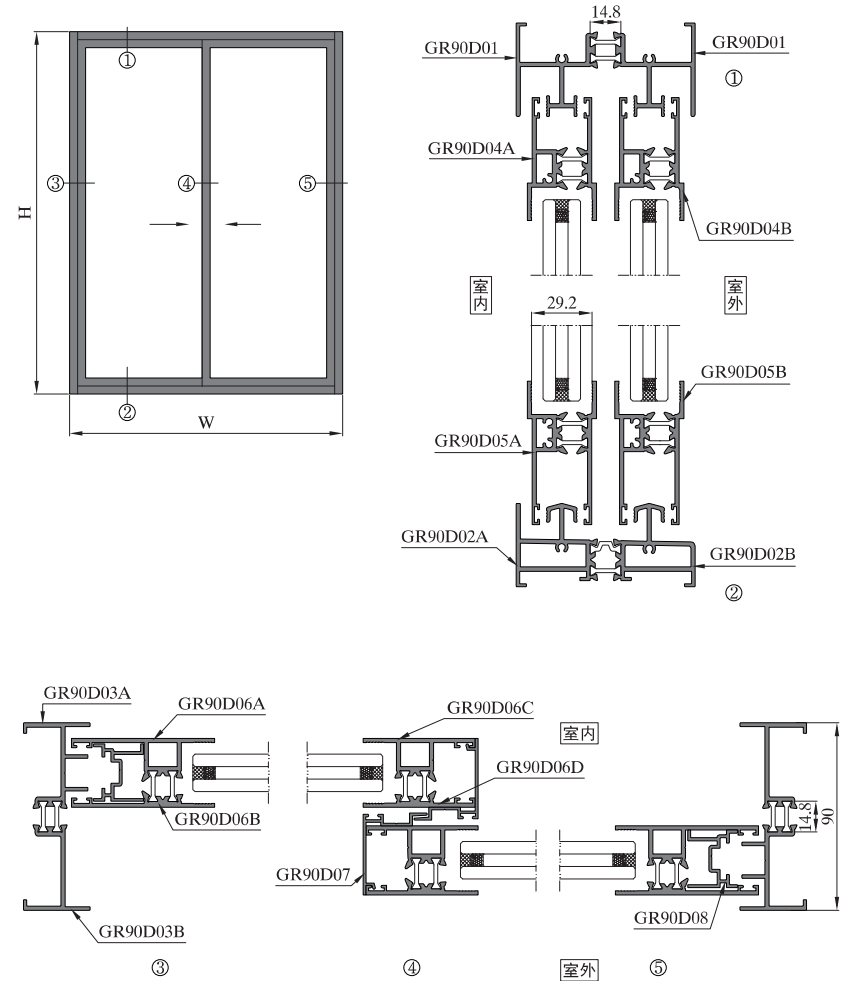

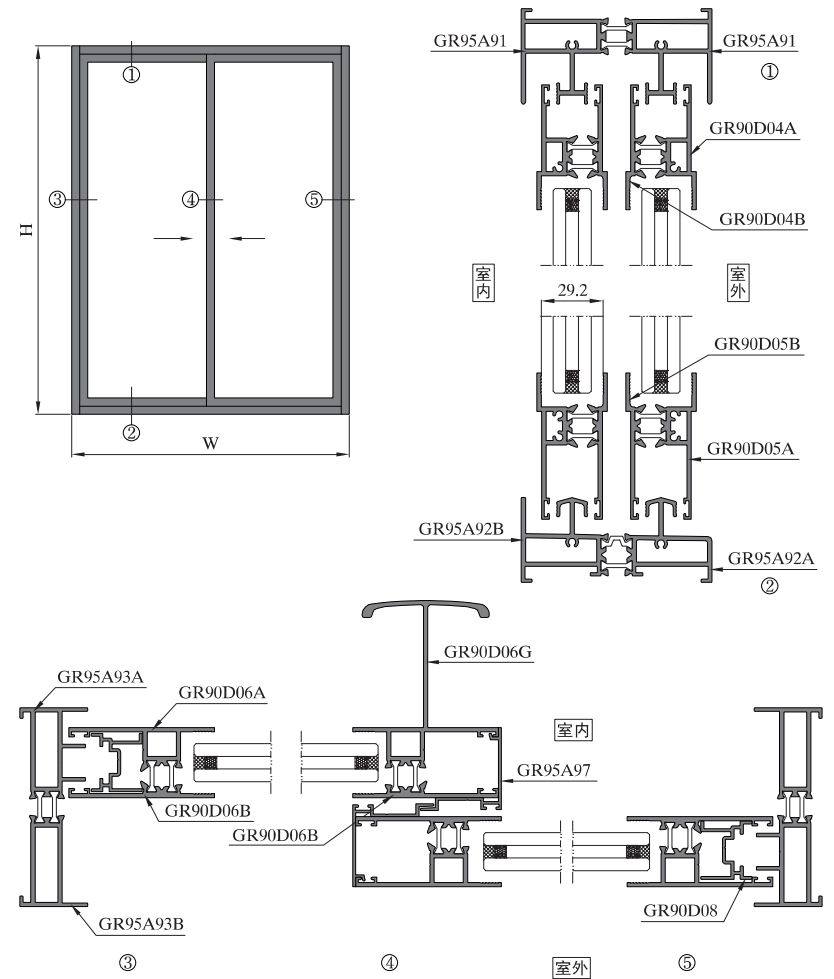
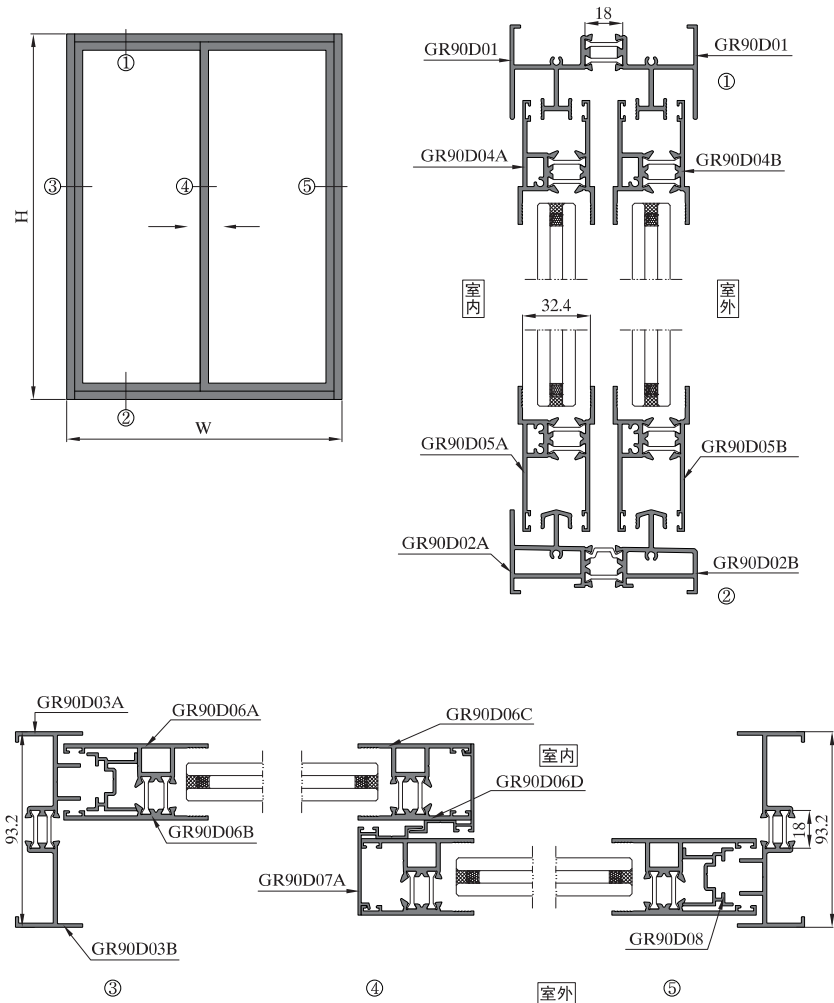
序号 S/N	型号理论重量 JMA Code & KG/M	型材图 Drawing	序号 S/N	型号理论重量 JMA Code & KG/M	型材图 Drawing	序号 S/N	型号理论重量 JMA Code & KG/M	型材图 Drawing
1	边框 GR70F61A GR70F61B 1.179kg/m	角码JMGR55B47J GR70F61A GR70F61B 47 1.4 24 70 12.2 27	10	中挺连接件 JMGR5707 0.592kg/m	15 28	19		
2	中挺 GR70F62A GR70F62B 1.388kg/m	GR70F62A GR70F62B 68.2 1.4 24 69.8 15.4 28.2	11	中挺连接件 JMGR55A97F 1.422kg/m	19.8 64.5	20		
3	中挺 GR70F62B GR70F62C 2.019kg/m	GR70F62C GR70F62B 68.2 34.4 1.4 2 24 70 12.4	12	连杆 JMGR5507A 0.153kg/m	4.3 19.3	21		
4	外扇 GR70F63A GR70F63B 1.622kg/m	角码JMGR55B47B GR70F63A GR70F63B 75 1.4 24 78 25.2	13	拼料 JMGR7598A JMGR7598A 0.604kg/m	JMGR7598A JMGR7598A 21.4 14.8 71.4	22		
5	内扇 GR70F63C GR70F63D 1.414kg/m	角码JMGR55B47J GR70F63D GR70F63C 64.7 1.4 24 78 12.2	14	转角 JMGR7598B GR80A18D 1.434kg/m	JMGR7598B GR80A18D 1.4 14.8 71.1	23		
6	压线 GR70F64A 0.255kg/m	开L135, 2mm 30.8 24.8 1	15	转角 JMGR7597C JMGR7638C 1.850kg/m	JMGR7638C JMGR7597C 1.4 14.8 71	24		
7	压线 GR70F64B 0.270kg/m	开L130, 2mm 35.8 24.8 1	16			25		
8	角码 JMGR55B47J 1.819kg/m	55 55 11.9	17			26		
9	角码 JMGR55B47B 2.146kg/m	60 60 24.9	18			27		

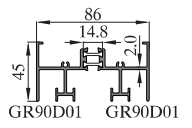
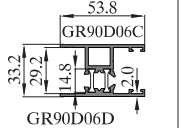
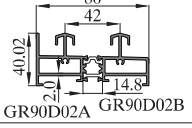
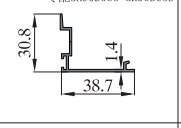
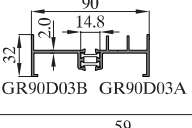
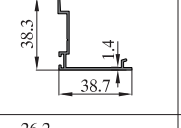
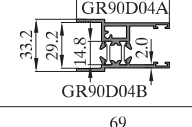
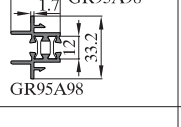
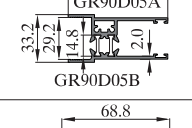
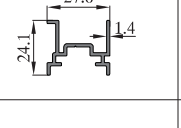
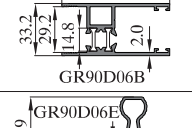
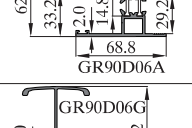

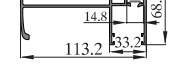

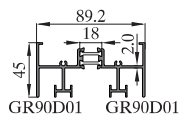
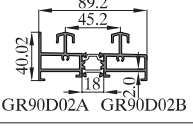
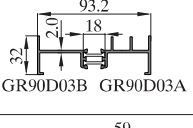
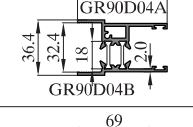
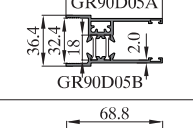
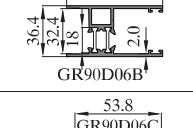
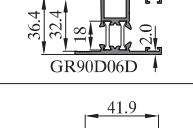
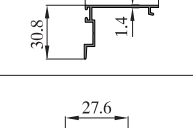
序号 S/N	型号理论重量 JMA Code & KG/M	型材图 Drawing	序号 S/N	型号理论重量 JMA Code & KG/M	型材图 Drawing	序号 S/N	型号理论重量 JMA Code & KG/M	型材图 Drawing
1	上滑 GR90D01 GR90D01 1.871kg/m		10	光企 GR90D06C GR90D06D 1.224kg/m		19		
2	下滑 GR90D02A GR90D02B 2.122kg/m		11	勾企扣条 GR90D07 0.324kg/m		20		
3	边封 GR90D03A GR90D03B 1.271kg/m		12	勾企扣条 GR95A97 0.350kg/m		21		
4	上方 GR90D04A GR90D04B 1.214kg/m		13	收口 GR95A98 GR95A98 0.611kg/m		22		
5	下方 GR90D05A GR90D05B 1.349kg/m		14	锁槽 GR90D08 0.374kg/m		23		
6	光企 GR90D06A GR90D06B 1.399kg/m		15			24		
7	光企 GR90D06A GR90D06E 1.834kg/m		16			25		
8	光企 GR90D06B GR90D06G 2.189kg/m		17			26		
9	光企 GR90D06B GR90D06F 2.306kg/m		18			27		

序号 S/N	型号理论重量 JMA Code & KG/M	型材图 Drawing	序号 S/N	型号理论重量 JMA Code & KG/M	型材图 Drawing	序号 S/N	型号理论重量 JMA Code & KG/M	型材图 Drawing
1	上滑 GR90D01 GR90D01 1.888kg/m		10			19		
2	下滑 GR90D02A GR90D02B 2.142kg/m		11			20		
3	边封 GR90D03A GR90D03B 1.288kg/m		12			21		
4	上方 GR90D04A GR90D04B 1.231kg/m		13			22		
5	下方 GR90D05A GR90D05B 1.366kg/m		14			23		
6	光企 GR90D06A GR90D06B 1.416kg/m		15			24		
7	光企 GR90D06C GR90D06D 1.241kg/m		16			25		
8	勾企扣条 GR90D07A 0.337kg/m		17			26		
9	锁槽 GR90D08 0.374kg/m		18			27		

图中所示型材截面、装配、编号、尺寸及重量仅供参考。如有疑问，请向本公司查询。
 Information above just for your reference. Please contact us if you have any questions, Thank you!

图中所示型材截面、装配、编号、尺寸及重量仅供参考。如有疑问，请向本公司查询。
 Information above just for your reference. Please contact us if you have any questions, Thank you!

序号 S/N	型号理论重量 JMA Code & KG/M	型材图 Drawing	序号 S/N	型号理论重量 JMA Code & KG/M	型材图 Drawing	序号 S/N	型号理论重量 JMA Code & KG/M	型材图 Drawing
1	上滑 GR95A91 2.313kg/m		10	光企 GR90D06C GR90D06D 1.224kg/m		19		
2	下滑 GR95A92A 2.173kg/m		11	勾企扣条 GR90D07 0.324kg/m		20		
3	边封 GR95A93A GR95A93B 1.719kg/m		12	勾企扣条 GR95A97 0.350kg/m		21		
4	上方 GR90D04A GR90D04B 1.214kg/m		13	收口 GR95A98 0.611kg/m		22		
5	下方 GR90D05A GR90D05B 1.349kg/m		14	锁槽 GR90D08 0.374kg/m		23		
6	光企 GR90D06A GR90D06B 1.399kg/m		15			24		
7	光企 GR90D06A GR90D06E 1.834kg/m		16			25		
8	光企 GR90D06B GR90D06G 2.189kg/m		17			26		
9	光企 GR90D06B GR90D06F 2.306kg/m		18			27		

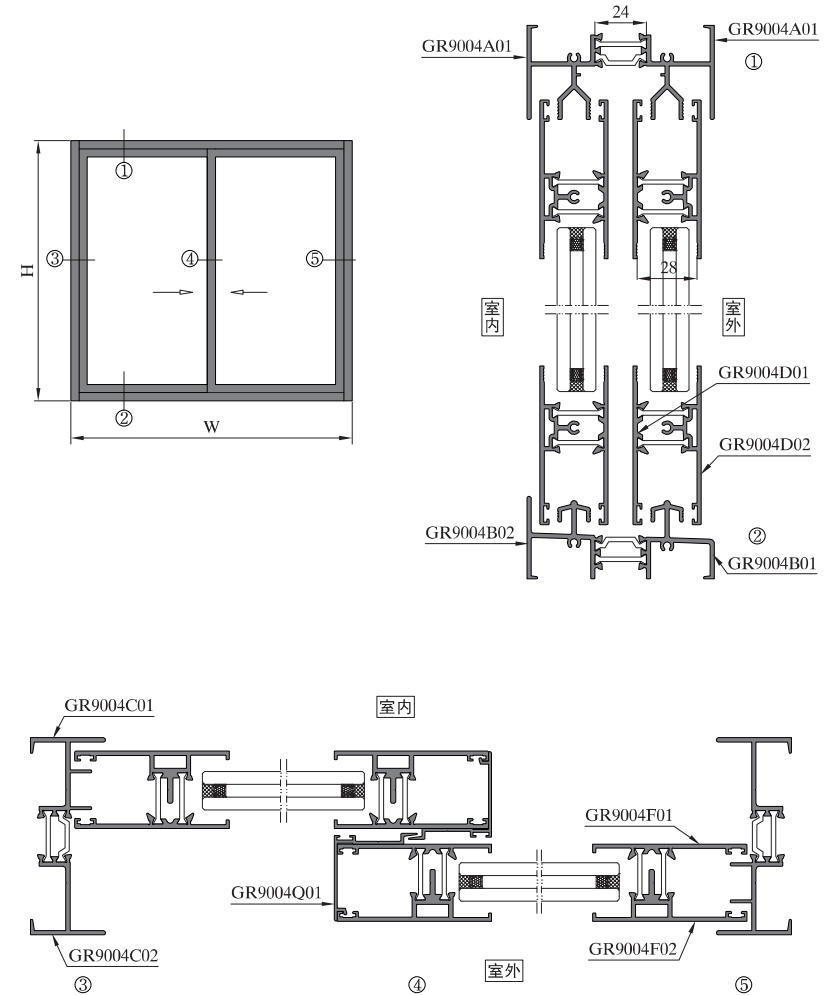



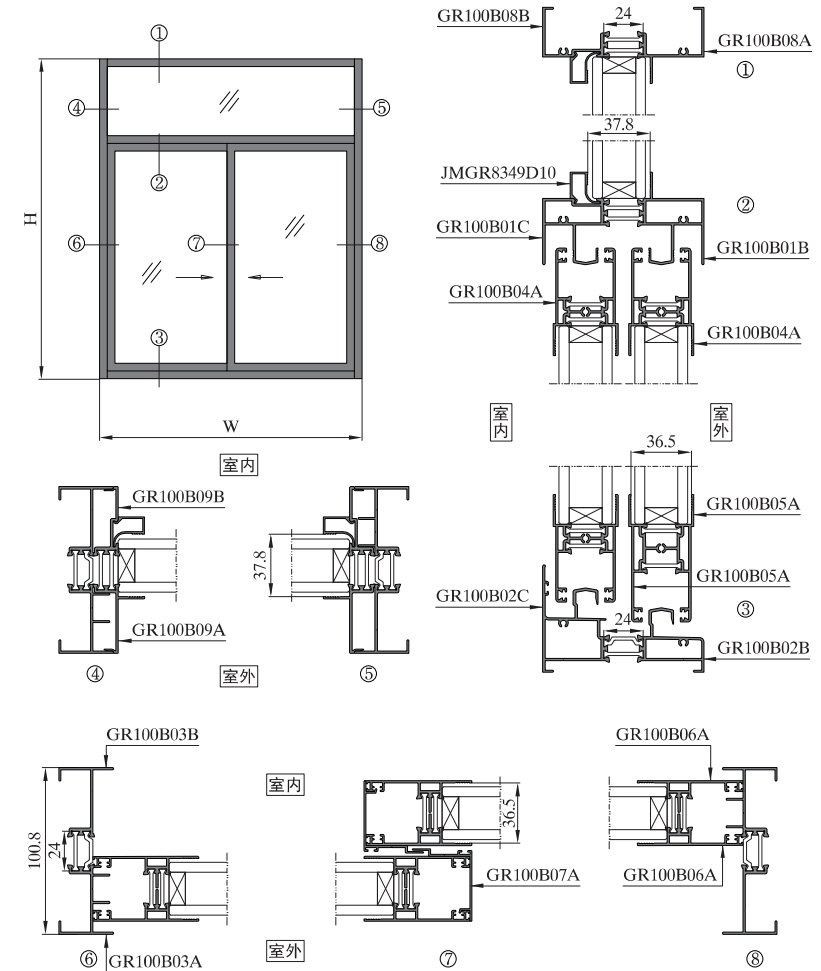

图中所示型材截面、装配、编号、尺寸及重量仅供参考。如有疑问，请向本公司查询。
Information above just for your reference. Please contact us if you have any questions, Thank you!

图中所示型材截面、装配、编号、尺寸及重量仅供参考。如有疑问，请向本公司查询。
Information above just for your reference. Please contact us if you have any questions, Thank you!

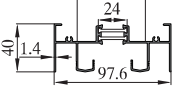
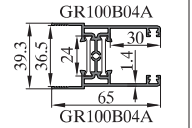
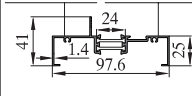
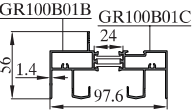
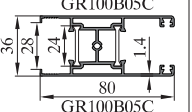
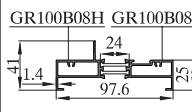
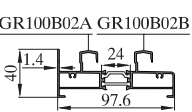
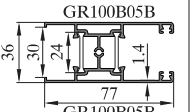
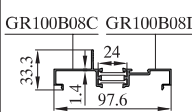
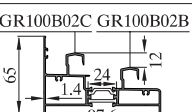
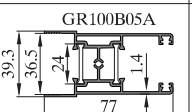
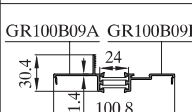
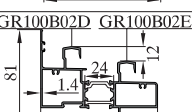
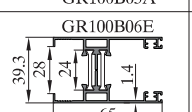
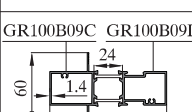
序号 S/N	型号理论重量 JMA Code & KG/M	型材图 Drawing	序号 S/N	型号理论重量 JMA Code & KG/M	型材图 Drawing	序号 S/N	型号理论重量 JMA Code & KG/M	型材图 Drawing
1	上滑 GR9004A01 GR9004A01 1.901kg/m		10			19		
2	下滑 GR9004B01 GR9004B02 1.702kg/m		11			20		
3	边封 GR9004C01 GR9004C02 1.335kg/m		12			21		
4	上下方 GR9004D01 GR9004D02 1.412kg/m		13			22		
5	光企 GR9004F01 GR9004F02 1.502kg/m		14			23		
6	勾企扣条 GR9004Q01 0.360kg/m		15			24		
7			16			25		
8			17			26		
9			18			27		

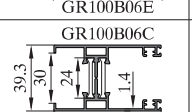
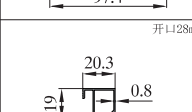

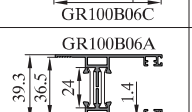
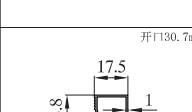
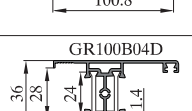
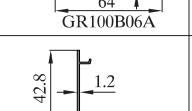
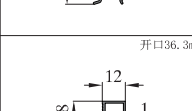
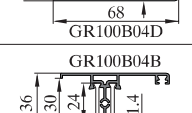
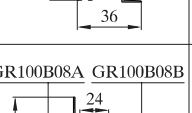
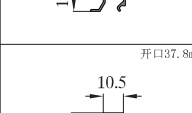
序号 S/N	型号理论重量 JMA Code & KG/M	型材图 Drawing	序号 S/N	型号理论重量 JMA Code & KG/M	型材图 Drawing	序号 S/N	型号理论重量 JMA Code & KG/M	型材图 Drawing
1	上滑 GR100B01A GR100B01A 1.471kg/m	GR100B01A GR100B01A 	10	上方 GR100B04A GR100B04A 1.231kg/m	GR100B04A 	19	上固 GR100B08F GR100B08G 1.093kg/m	GR100B08F GR100B08G 
2	固上滑 GR100B01B GR100B01C 1.801kg/m	GR100B01B GR100B01C 	11	下方 GR100B05C GR100B05C 1.499kg/m	GR100B05C 	20	上固 GR100B08H GR100B08J 1.369kg/m	GR100B08H GR100B08J 
3	下滑 GR100B02A GR100B02B 1.612kg/m	GR100B02A GR100B02B 	12	下方 GR100B05B GR100B05B 1.449kg/m	GR100B05B 	21	反插板 GR100B08C GR100B08D 0.962kg/m	GR100B08C GR100B08D 
4	下滑 GR100B02B GR100B02C 1.783kg/m	GR100B02C GR100B02B 	13	下方 GR100B05A GR100B05A 1.443kg/m	GR100B05A 	22	边封插板 GR100B09A GR100B09B 0.860kg/m	GR100B09A GR100B09B 
5	固下滑 GR100B02D GR100B02E 1.970kg/m	GR100B02D GR100B02E 	14	光企 GR100B06E GR100B06E 1.244kg/m	GR100B06E 	23	中柱 GR100B09C GR100B09D 1.589kg/m	GR100B09C GR100B09D 
6	边封 GR100B03A GR100B03B 1.116kg/m	GR100B03A GR100B03B 	15	光企 GR100B06C GR100B06C 1.216kg/m	GR100B06C 	24	压线 GR100B08E 0.165kg/m	
7	边封 GR100B03C GR100B03D 1.403kg/m	GR100B03C GR100B03D 	16	光企 GR100B06A GR100B06A 1.186kg/m	GR100B06A 	25	压线 JMGR8349B10 0.178kg/m	
8	上方 GR100B04D GR100B04D 1.290kg/m	GR100B04D 	17	勾企扣条 GR100B07A 0.309kg/m		26	压线 JMGR8349I10 0.168kg/m	
9	上方 GR100B04B GR100B04B 1.240kg/m	GR100B04B 	18	上固 GR100B08A GR100B08B 1.134kg/m	GR100B08A GR100B08B 	27	压线 JMGR8349D10 0.164kg/m	

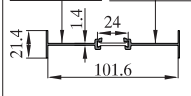
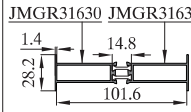
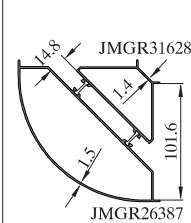
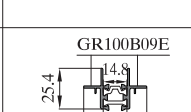
序号 S/N	型号理论重量 JMA Code & KG/M	型材图 Drawing	序号 S/N	型号理论重量 JMA Code & KG/M	型材图 Drawing	序号 S/N	型号理论重量 JMA Code & KG/M	型材图 Drawing
28	拼料 GR100B09F GR100B09F 0.694kg/m	GR100B09F GR100B09F 	36			45		
29	拼料 JMGR31630 JMGR31630 1.270kg/m	JMGR31630 JMGR31630 	37			46		
30	转角 JMGR26387 JMGR31628 2.915kg/m		38			47		
			39			48		
31	收口 GR100B09E GR100B09E 0.563kg/m	GR100B09E 	40			49		
32			41			50		
33			42			51		
34			43			52		
35			44			53		

图中所示型材截面、装配、编号、尺寸及重量仅供参考。如有疑问，请向本公司查询。
 Information above just for your reference. Please contact us if you have any questions, Thank you!

图中所示型材截面、装配、编号、尺寸及重量仅供参考。如有疑问，请向本公司查询。
 Information above just for your reference. Please contact us if you have any questions, Thank you!

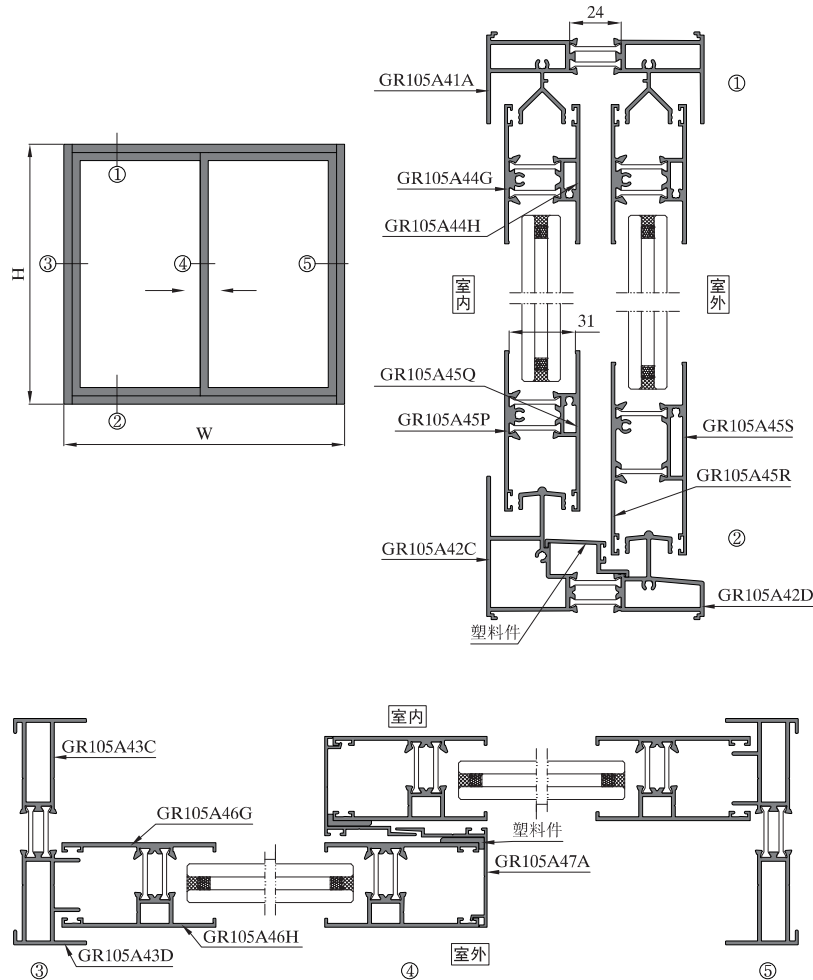

序号 S/N	型号理论重量 JMA Code & KG/M	型材图 Drawing	序号 S/N	型号理论重量 JMA Code & KG/M	型材图 Drawing	序号 S/N	型号理论重量 JMA Code & KG/M	型材图 Drawing
1	上滑 GR105A41A GR105A41A T=1.8 2.240kg/m		10	下方 GR105A45M GR105A45N T=1.8 1.666kg/m		19		
2	下滑 GR105A42C GR105A42D T=1.8 2.436kg/m		11	光企 GR105A46H GR105A46G T=1.8 1.372kg/m		20		
3	固下滑 GR105A42E GR105A42F T=1.8 2.520kg/m		12	光企 GR105A46E GR105A46F T=1.8 1.346kg/m		21		
4	边封 GR105A43C GR105A43D T=1.8 1.740kg/m		13	勾企扣条 GR105A47A T=1.4 0.414kg/m		22		
5	上方 GR105A44G GR105A44H T=1.8 1.308kg/m		14	上固 GR105A48C GR105A48D T=1.8 1.647kg/m		23		
6	上方 GR105A44E GR105A44F T=1.8 1.319kg/m		15	压线 GR105A09A T=0.9 0.183kg/m		24		
7	下方 GR105A45P GR105A45Q T=1.8 1.413kg/m		16	压线 GR105A09B T=0.9 0.201kg/m		25		
8	下方 GR105A45R GR105A45S T=1.8 1.655kg/m		17	收口 GR105A09C GR105A09C 0.609kg/m		26		
9	下方 GR105A45K GR105A45L T=1.8 1.425kg/m		18	连杆槽 GR105A09D 0.348kg/m		27		

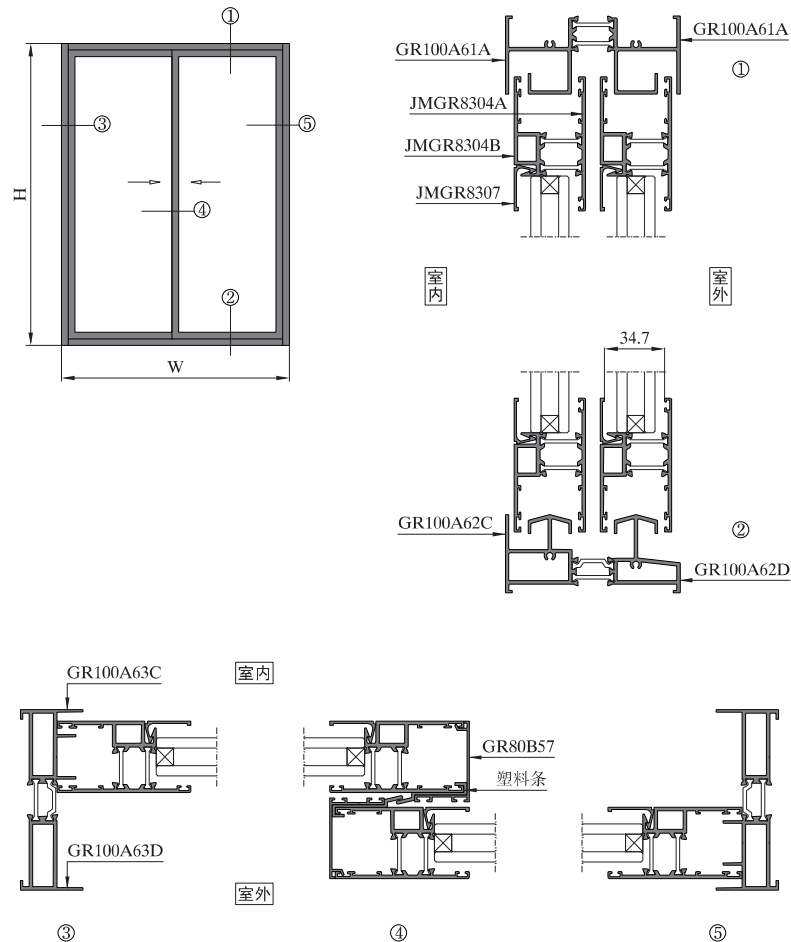

序号 S/N	型号理论重量 JMA Code & KG/M	型材图 Drawing	序号 S/N	型号理论重量 JMA Code & KG/M	型材图 Drawing	序号 S/N	型号理论重量 JMA Code & KG/M	型材图 Drawing
1	上滑 GR100A61A GR100A61A 2.195kg/m		10	收口 JMGR8305A JMGR8305A 0.702kg/m		19		
2	下滑 GR100A62C GR100A62D 2.395kg/m		11	角码 JMGR9013B 2.017kg/m		20		
3	边封 GR100A63C GR100A63D 1.824kg/m		12			21		
4	扇料 JMGR8304A JMGR8304B 1.461kg/m		13			22		
5	压线 JMGR8307D 0.253kg/m		14			23		
6	压线 JMGR8307P 0.192kg/m		15			24		
7	压线 JMGR8307 0.160kg/m		16			25		
8	勾企盖板 GR80B57 0.359kg/m		17			26		
9	锁槽 GR100A69 0.380kg/m		18			27		

序号 S/N	型号理论重量 JMA Code & KG/M	型材图 Drawing	序号 S/N	型号理论重量 JMA Code & KG/M	型材图 Drawing	序号 S/N	型号理论重量 JMA Code & KG/M	型材图 Drawing
28	1.410kg/m	压线配GRI9014 玻璃开口25mm GRI9010E GRI9010F	37	2.607kg/m	压线配GRI9014 玻璃开口25mm GRI9011S20 GRI9011S20	46	2.402kg/m	压线配GRI9014 玻璃开口25mm GRI9017B
29	2.125kg/m	压线配GRI9014 玻璃开口25mm GRI9010B20 GRI9010A20	38	2.628kg/m	压线配GRI9014 玻璃开口25mm GRI9011E GRI9011C	47	4.494kg/m	压线配GRI9014 玻璃开口33mm GRI9018B
30	2.400kg/m	压线配GRI9014 玻璃开口25mm GRI9009B20 GRI9009A20	39	3.865kg/m	压线配GRI9014 玻璃开口25mm GRI9011G GRI9011F	48	3.412kg/m	压线配GRI9014 玻璃开口25mm GRI9017C
31	2.468kg/m	压线配GRI9014 玻璃开口25mm GRI9011B20 GRI9011A20	40	2.786kg/m	压线配GRI9014 玻璃开口25mm GRI9011B20 GRI9011T20	49	GRI9014 0.215kg/m	
32	1.833kg/m	压线配GRI9014 玻璃开口25mm GRI9011B GRI9011J14	41	4.184kg/m	压线配GRI9014 玻璃开口25mm GRI9011G GRI9011G	50	GRI9014A 0.189kg/m	
33	2.182kg/m	压线配GRI9014 玻璃开口25mm GRI9022 GRI9022	42	4.534kg/m	压线配GRI9014 玻璃开口25mm GRI9011WA GRI9011WA	51	GRI9014B 0.179kg/m	
34	2.511kg/m	压线配GRI9014 玻璃开口25mm GRI9011D GRI9011C	43	2.840kg/m	压线配GRI9014 玻璃开口25mm GRI9011R20 GRI9011R20	52	GRI9014C 0.186kg/m	
35	2.803kg/m	压线配GRI9014 玻璃开口33mm GRI9021B GRI9021A	44	6.769kg/m	压线配GRI9014 玻璃开口25mm GRI9011W GRI9011W	53	GRI9014D 0.175kg/m	
36	2.781kg/m	压线配GRI9014 玻璃开口33mm GRI9019B GRI9019A	45	2.452kg/m	压线配GRI9014 玻璃开口25mm GRI9016B	54	GRI9015A 0.055kg/m	

序号 S/N	型号理论重量 JMA Code & KG/M	型材图 Drawing	序号 S/N	型号理论重量 JMA Code & KG/M	型材图 Drawing	序号 S/N	型号理论重量 JMA Code & KG/M	型材图 Drawing
55	2.246kg/m	JMGR5089	64	2.676kg/m	JMGR6040ZB JMGR6040ZB	73	1.892kg/m	JMGR6040CA
56	0.890kg/m	JMGR6040R JMGR6040R	65	2.579kg/m	JMGR6040PA JMGR6040PB	74	1.636kg/m	JMGR6040CD
57	0.866kg/m	GRC6008 GRC6008	66	3.429kg/m	JMGR6040PC JMGR6040PB	75	1.387kg/m	JMGR6040CH
58	1.331kg/m	JMGR6040A JMGR6040A	67	4.253kg/m	JMGR6040MA JMGR6040LA	76	3.002kg/m	JMGR6040ZA
59	1.223kg/m	GRC7630 GRC7630	68	2.304kg/m	JMGR6040E	77	2.067kg/m	JMGR6040GA16
60	1.333kg/m	JMGR6040BA16 JMGR6040BA16	69	2.538kg/m	JMGR6040G	78	0.809kg/m	JMZJ0016C
61	1.739kg/m	JMGR6040B JMGR6040B	70	2.555kg/m	JMGR6040G	79	0.875kg/m	JMZJ0016B
62	2.091kg/m	JMGR6040ZD JMGR6040ZC	71	3.406kg/m	JMGR6040C	80	1.161kg/m	JMZJ0016A
63	1.953kg/m	JMGR6040BC JMGR6040BC	72	1.773kg/m	JMGR6040CF	81	1.284kg/m	JMZJ0016

图中所示型材截面、装配、编号、尺寸及重量仅供参考。如有疑问，请向本公司查询。
Information above just for your reference. Please contact us if you have any questions, Thank you!

图中所示型材截面、装配、编号、尺寸及重量仅供参考。如有疑问，请向本公司查询。
Information above just for your reference. Please contact us if you have any questions, Thank you!

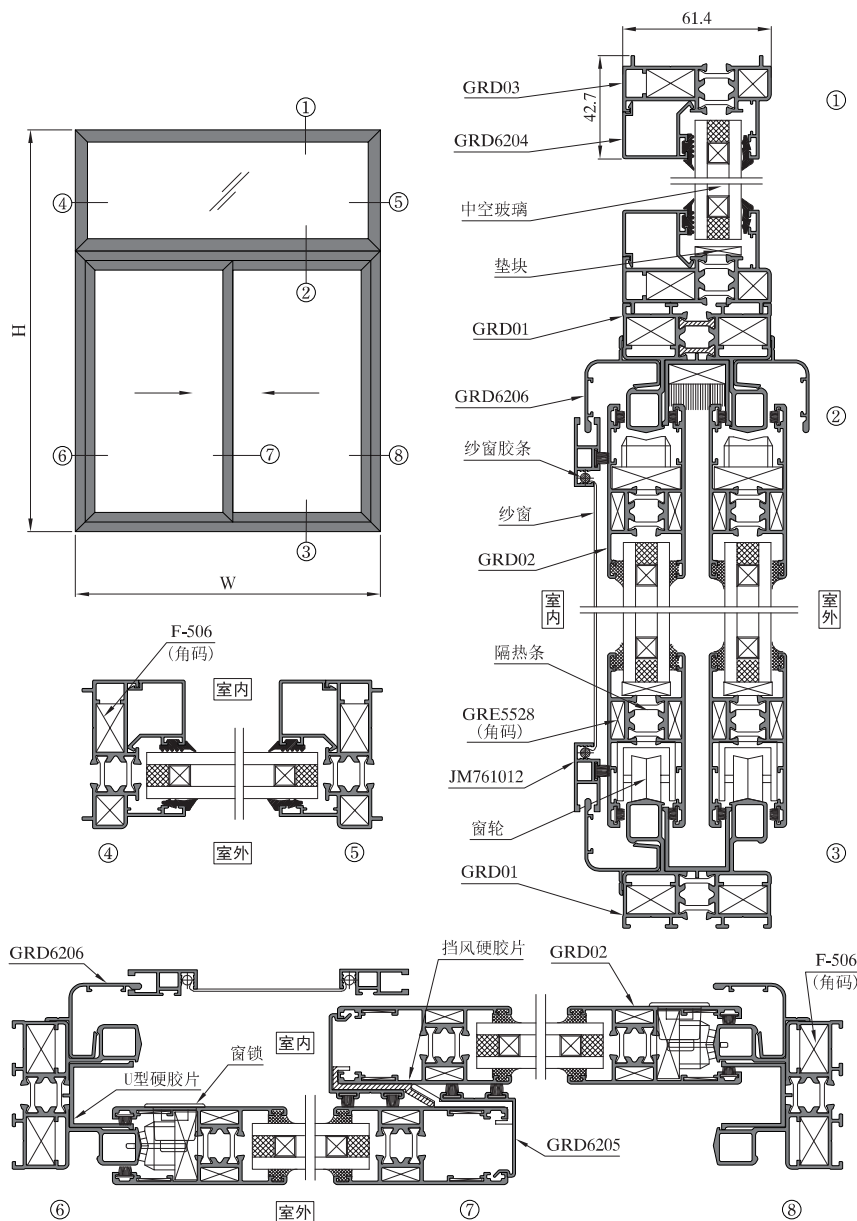

序号 S/N	型号理论重量 JMA Code & KG/M	型材图 Drawing	序号 S/N	型号理论重量 JMA Code & KG/M	型材图 Drawing	序号 S/N	型号理论重量 JMA Code & KG/M	型材图 Drawing
1	框料 GRD6201A GRD6201A 1.691kg/m		10	压线 GRD6204 0.296kg/m		19		
2	框料 GRD6201A GRD6201B GRD6201A 2.718kg/m		11	压线 GRD6204A 0.240kg/m		20		
3	框料 GRD6201A GRD6201E 1.895kg/m		12	压线 GRD6204B 0.288kg/m		21		
4	扇料 GRD6202A GRD6202A 1.255kg/m		13	勾企扣条 GRD6205 0.292kg/m		22		
5	光企 GRD6202A16 GRD6202B16 1.865kg/m		14	GRD6206 0.336kg/m		23		
6	光企 GRD6202D GRD6202D 1.225kg/m		15	收口 GRD6210A GRD6210A 0.613kg/m		24		
7	框料 GRD6203A GRD6203B 1.094kg/m		16			25		
8	中挺 GRD6207A GRD6207B 1.236kg/m		17			26		
9	转角 GRD6209A GRD6209B 2.156kg/m		18			27		

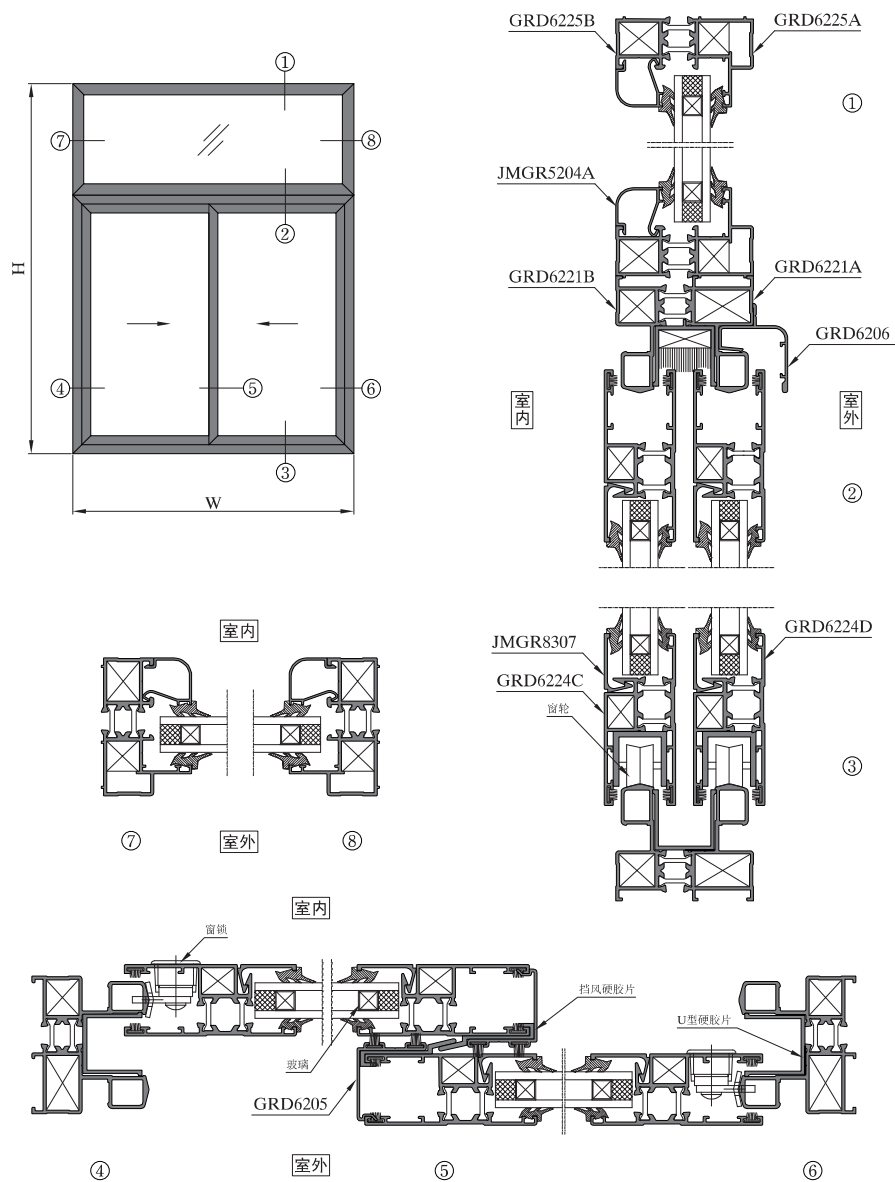

序号 S/N	型号理论重量 JMA Code & KG/M	型材图 Drawing	序号 S/N	型号理论重量 JMA Code & KG/M	型材图 Drawing	序号 S/N	型号理论重量 JMA Code & KG/M	型材图 Drawing
1	框料 GRD6221A GRD6221B 1.599kg/m	角码配JMGR9013 GRD6221A 57 14.8 1.6 52.5 22.5 14.7 61.8	10			19		
2	框料 GRD6221B GRD6221C 1.800kg/m	角码配JMGR9013 GRD6221C 57 14.8 4.6 14.7 23.7 61.8 77.2	11			20		
3	框料 GRD6222A GRD6222B 1.960kg/m	角码配JMGR9013 GRD6222B 57 14.8 12 14.7 23.7 62.6 53.7	12			21		
4	扇料 GRD6224C GRD6224D 1.176kg/m	角码配JMGR9013 GRD6224C 14.7 1.4 14.7 5.2 77.2	13			22		
5	框料 GRD6225A GRD6225B 1.126kg/m	角码配JMGR9013 GRD6225A GRD6225B 14 14.8 1.4 14 23.5 61.8	14			23		
6	勾企扣条 GRD6205 0.292kg/m	35.1 1.2 31	15			24		
7	GRD6206 0.336kg/m	40 1.2 31	16			25		
8	压线 JMGR5204A 0.193kg/m	玻璃开口27mm 21 1.3 21.9 15.8	17			26		
9	角码 JMGR9013 2.051kg/m	60 14.4 60	18			27		

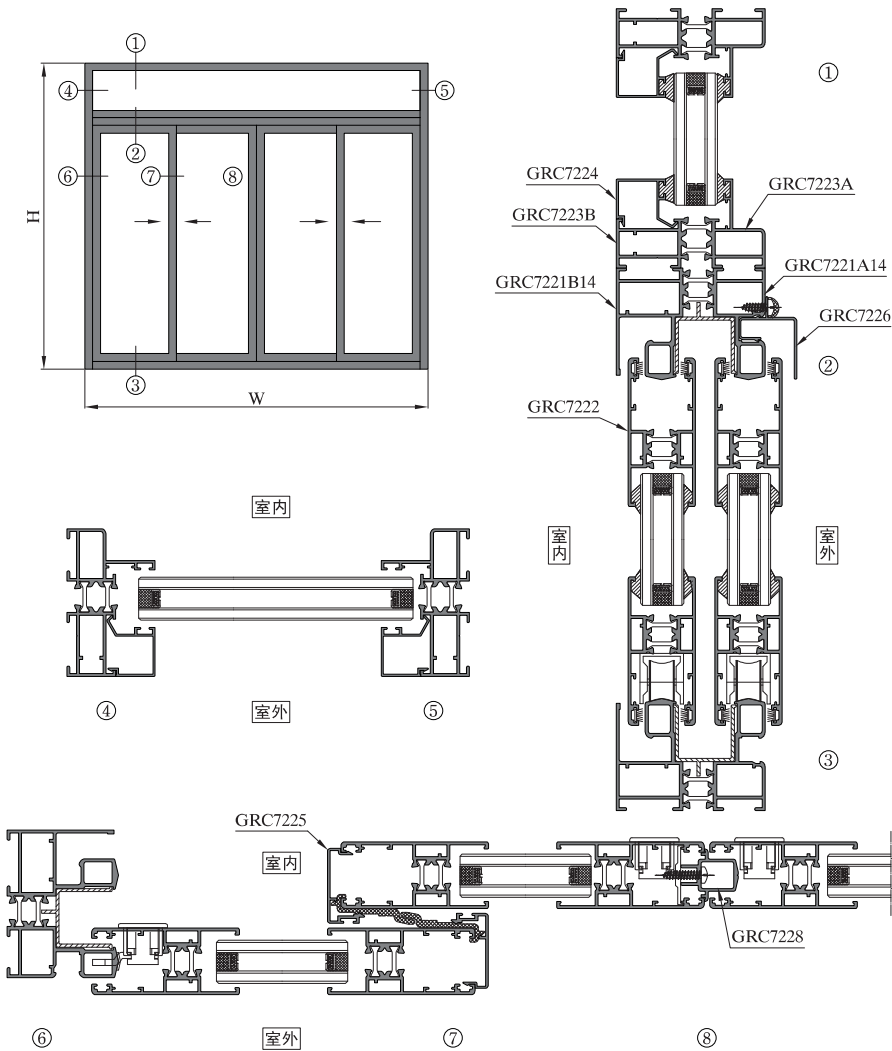

序号 S/N	型号理论重量 JMA Code & KG/M	型材图 Drawing	序号 S/N	型号理论重量 JMA Code & KG/M	型材图 Drawing	序号 S/N	型号理论重量 JMA Code & KG/M	型材图 Drawing
1	框料 GRC7221A14 GRC7221B14 1.971kg/m		10			19		
2	框料 GRC7221C GRC7221D GRC7221E 3.465kg/m		11			20		
3	扇料 GRC7222 GRC7222 1.268kg/m		12			21		
4	扇料 GRC7222A GRC7222A 1.508kg/m		13			22		
5	固定框 GRC7223A GRC7223B 1.278kg/m		14			23		
6	压线 GRC7224 0.255kg/m		15			24		
7	勾企扣条 GRC7225 0.274kg/m		16			25		
8	挡水板 GRC7226 0.276kg/m		17			26		
9	收口 GRC7228 0.387kg/m		18			27		

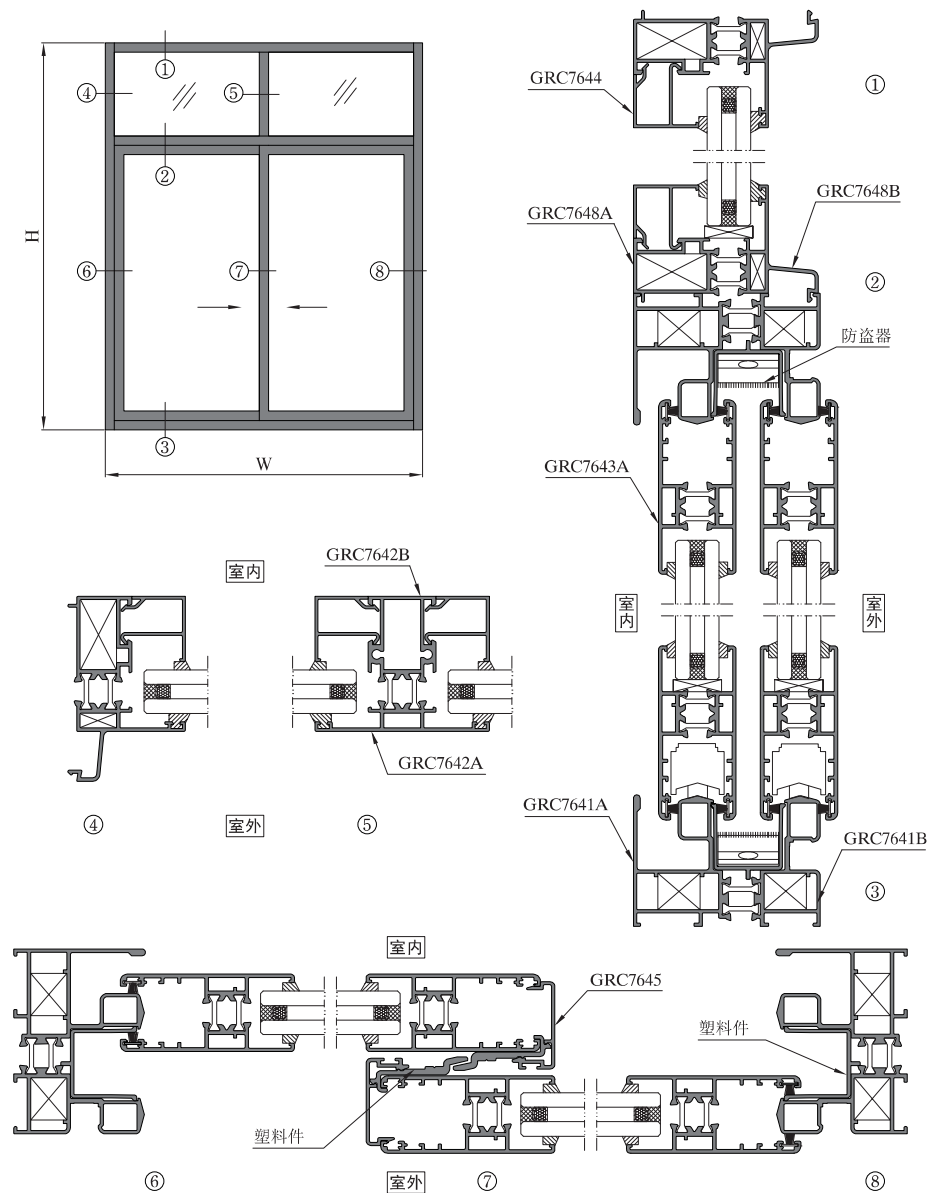
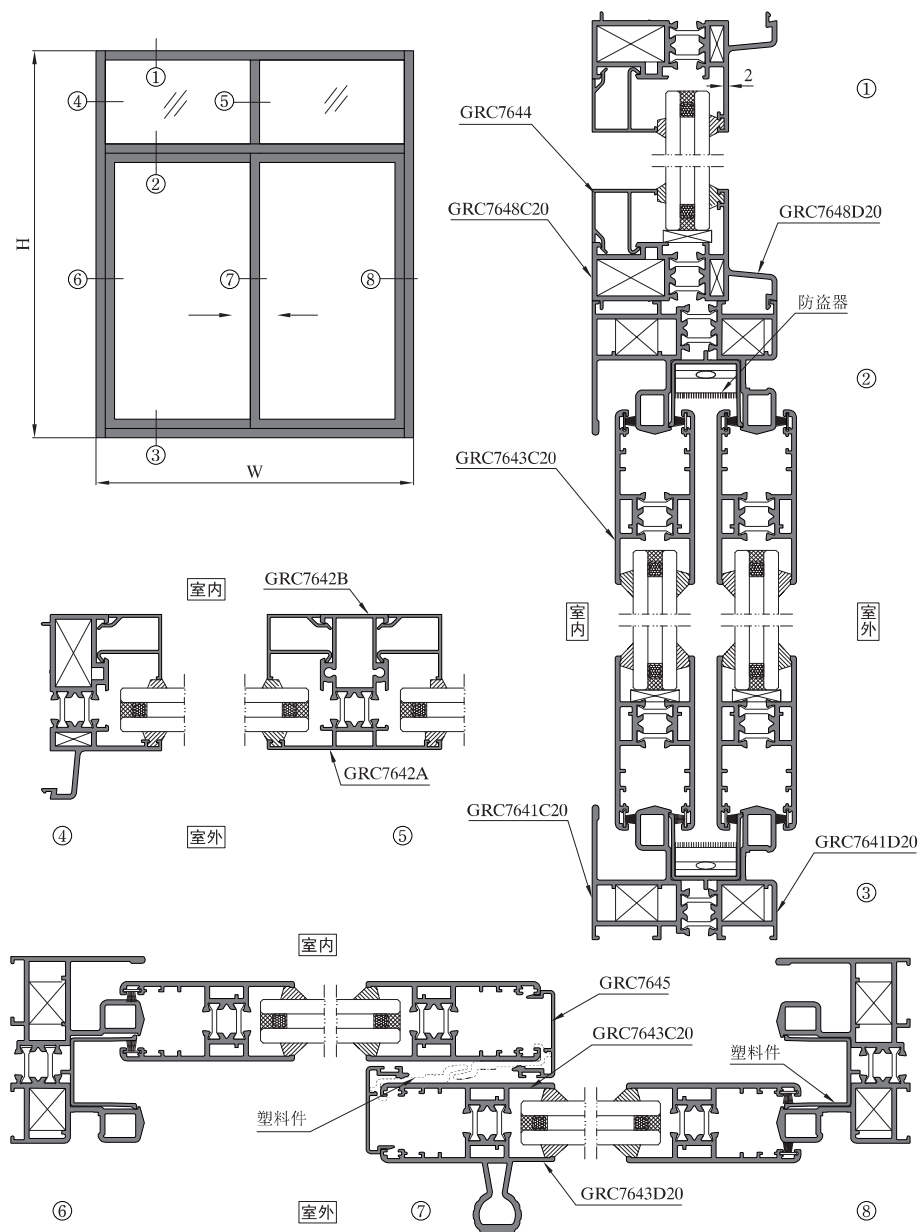

序号 S/N	型号理论重量 JMA Code & KG/M	型材图 Drawing	序号 S/N	型号理论重量 JMA Code & KG/M	型材图 Drawing	序号 S/N	型号理论重量 JMA Code & KG/M	型材图 Drawing
1	框料 GRC7641A GRC7641B 1.949kg/m		10	勾企扣条 GRC7645 0.301kg/m		19	纱窗压线 GRC7649 0.160kg/m	
2	框料 GRC7641C20 GRC7641D20 2.508kg/m		11	勾企扣条 GRC7645A 0.449kg/m		20	纱窗 GRC7649A 1.077kg/m	
3	框料 GRC7641A GRC7641E GRC7641B 2.924kg/m		12	勾企扣条 GRC7645B 0.712kg/m		21		
4	中柱 GRC7642A GRC7642B 1.405kg/m		13	收口 GRC7646 0.270kg/m		22		
5	扇料 GRC7643A GRC7643A 1.279kg/m		14	90° 转角 GRC7647A GRC7647B 1.790kg/m		23		
6	扇料 GRC7643C20 GRC7643C20 1.542kg/m		15	135° 转角 GRC7647C GRC7647D 1.455kg/m		24		
7	扇料 GRC7643A GRC7643B 1.783kg/m		16	拼管 GRC7647E GRC7647E 0.561kg/m		25		
8	扇料 GRC7643C20 GRC7643D20 2.073kg/m		17	框料 GRC7648A GRC7648B 1.257kg/m		26		
9	框压线 GRC7644 0.312kg/m		18	框料 GRC7648C20 GRC7648D20 1.622kg/m		27		

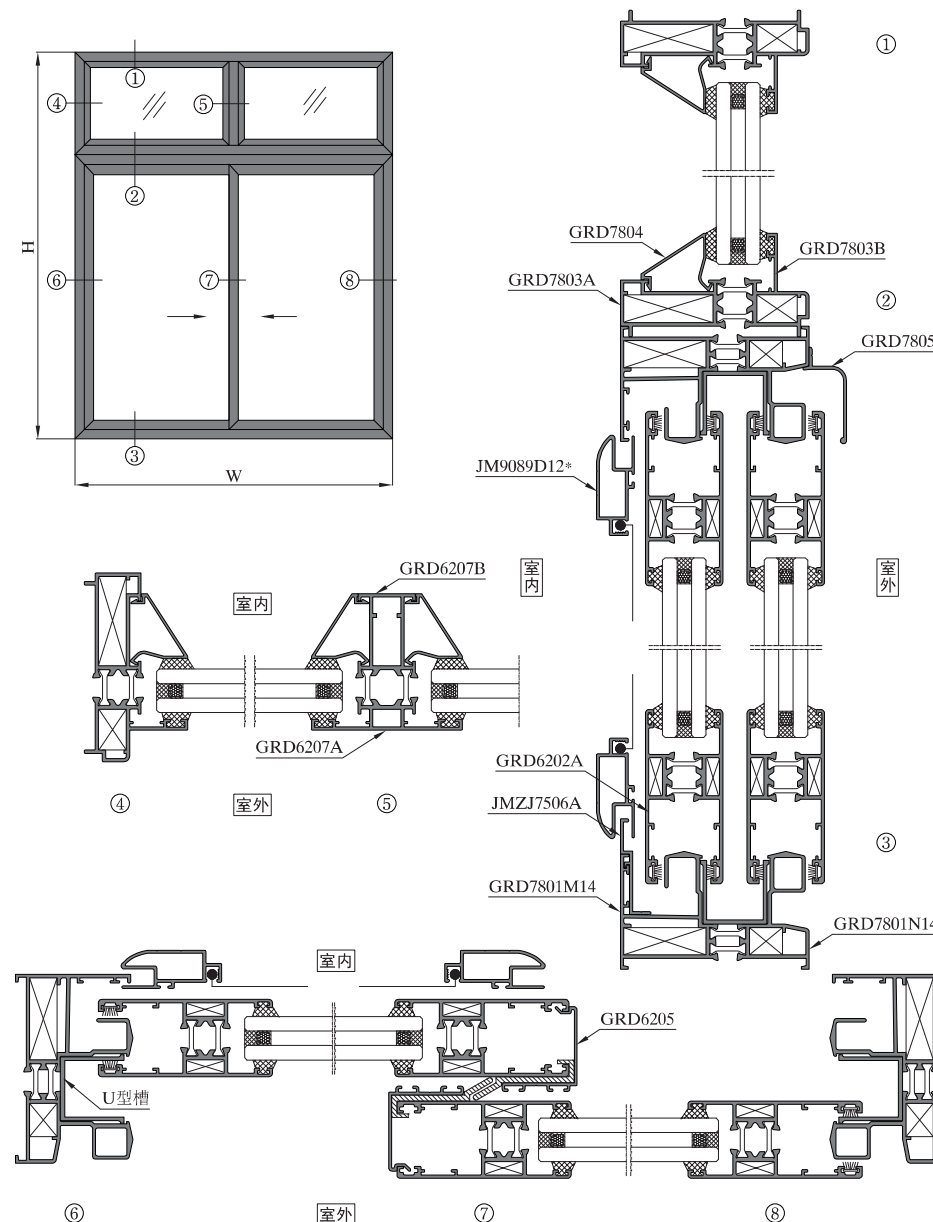

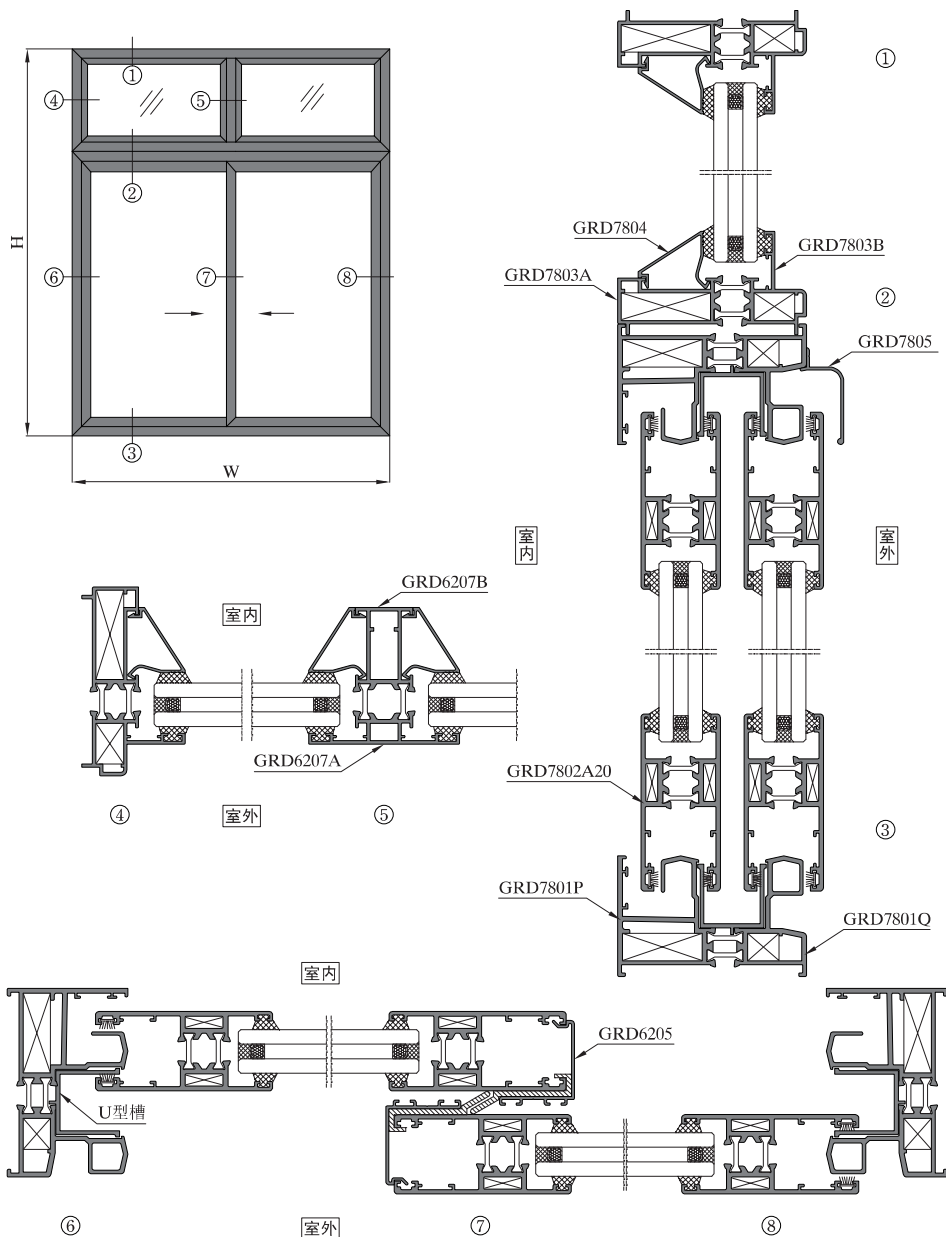

序号 S/N	型号理论重量 JMA Code & KG/M	型材图 Drawing	序号 S/N	型号理论重量 JMA Code & KG/M	型材图 Drawing	序号 S/N	型号理论重量 JMA Code & KG/M	型材图 Drawing
1	框料 GRD7801P GRD7801Q 2.030kg/m	角码配F-50625 GRD7801P GRD7801Q 49.8 2 11.3 14.8 78	10	压线 GRD6204 0.296kg/m	玻璃开口25mm 26.9 1.2 23.8	19	纱窗料 JM9089D12 [®] 0.423kg/m	15.7 1.2 41.5
2	框料 GRD7801M14 GRD7801N14 1.697kg/m	角码配F-50625 GRD7801M14 GRD7801N14 48.6 1.4 11.3 14.8 78	11	压线 GRD7804 0.200kg/m	玻璃开口25mm 26.9 23.7 23.7	20	收口 GRD6210A GRD6210A 0.613kg/m	GRD6210A 12 14.5 30 29.4
3	扇料 GRD7802A20 GRD7802B20 2.094kg/m	GRD7802B20 2 2 14.8 32.8 73.2 GRD7802A20	12	压线 GRD6204B 0.288kg/m	玻璃开口29mm 22.9 19.2 1.2 23.8	21		
4	扇料 GRD7802A20 GRD7802A20 1.540kg/m	GRD7802A20 GRD7802A20 2 2 14.8 32.8 73.2	13	压线 GRD7804A 0.190kg/m	玻璃开口29mm 22.9 19.2 23.7 23.7	22		
5	扇料 GRD6202A GRD6202A 1.255kg/m	GRD6202A GRD6202A 2 2 14.8 32.8 72	14	压线 GRD6204A 0.240kg/m	玻璃开口25mm 26.9 19.2 0.9 23.8	23		
6	扇料 GRD6202D GRD6202D 1.225kg/m	GRD6202D GRD6202D 2 2 14.8 32.8 72	15	勾企扣条 GRD6205 0.292kg/m	35.1 1.2 31	24		
7	扇料 GRD7802C20 GRD7802C20 1.503kg/m	GRD7802C20 GRD7802C20 2 2 14.8 32.8 73.2	16	转角 JMGR6040G JMGR6040H 2.555kg/m	JMGR6040G 2 85 14.8 JMGR6040H 85	25		
8	框料 GRD7803A GRD7803B 1.242kg/m	角码配F-50625 GRD7803A GRD7803B 4 14.8 11.3 42.7 78	17	JMZJ7506A 0.195kg/m	12.6 1.2 39.5	26		
9	中挺 GRD6207A GRD6207B 1.236kg/m	GRD6207A GRD6207B 62.3 14.8 1.4 23.7 56.4	18	档水板 GRD7805 0.197kg/m	1.2 18 40	27		

图中所示型材截面、装配、编号、尺寸及重量仅供参考。如有疑问，请向本公司查询。
Information above just for your reference. Please contact us if you have any questions, Thank you!

图中所示型材截面、装配、编号、尺寸及重量仅供参考。如有疑问，请向本公司查询。
Information above just for your reference. Please contact us if you have any questions, Thank you!

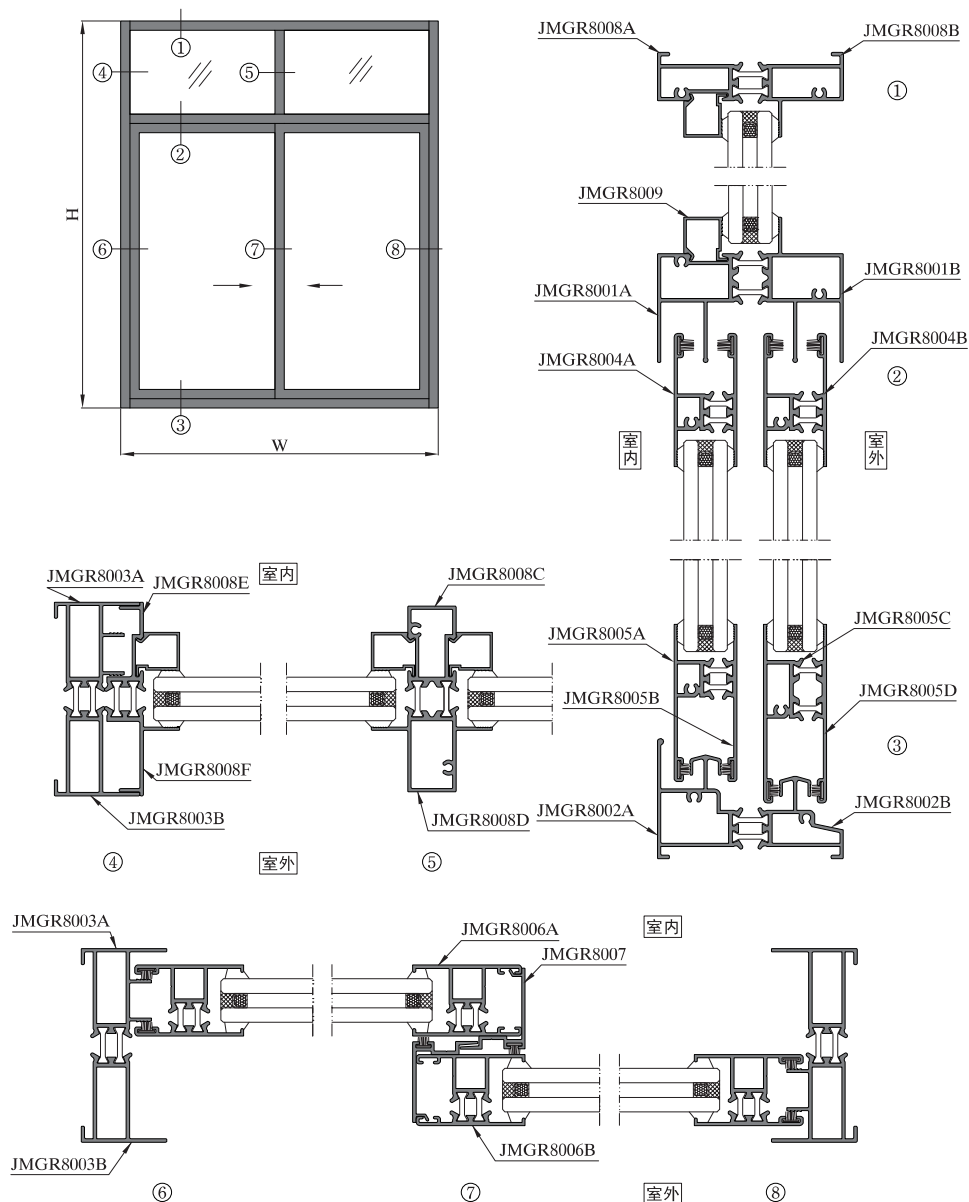

序号 S/N	型号理论重量 JMA Code & KG/M	型材图 Drawing	序号 S/N	型号理论重量 JMA Code & KG/M	型材图 Drawing	序号 S/N	型号理论重量 JMA Code & KG/M	型材图 Drawing
1	上滑 JMGR8001A JMGR8001B 1.643kg/m		10	上固 JMGR8008A JMGR8008B 1.178kg/m		19		
2	上滑 JMGR8001C JMGR8001C 1.516kg/m		11	中柱 JMGR8008C JMGR8008D 1.317kg/m		20		
3	下滑 JMGR8002A JMGR8002B 1.515kg/m		12	插板 JMGR8008E JMGR8008F 0.805kg/m		21		
4	边封 JMGR8003A JMGR8003B 1.267kg/m		13	压线 JMGR8009 0.172kg/m		22		
5	上方 JMGR8004A JMGR8004B 0.917kg/m		14	压线 JMGR8009A 0.150kg/m		23		
6	下方 JMGR8005A JMGR8005B 0.999kg/m		15			24		
7	下方 JMGR8005C JMGR8005D 1.157kg/m		16			25		
8	光企 JMGR8006A JMGR8006B 0.845kg/m		17			26		
9	勾企 JMGR8007 0.293kg/m		18			27		

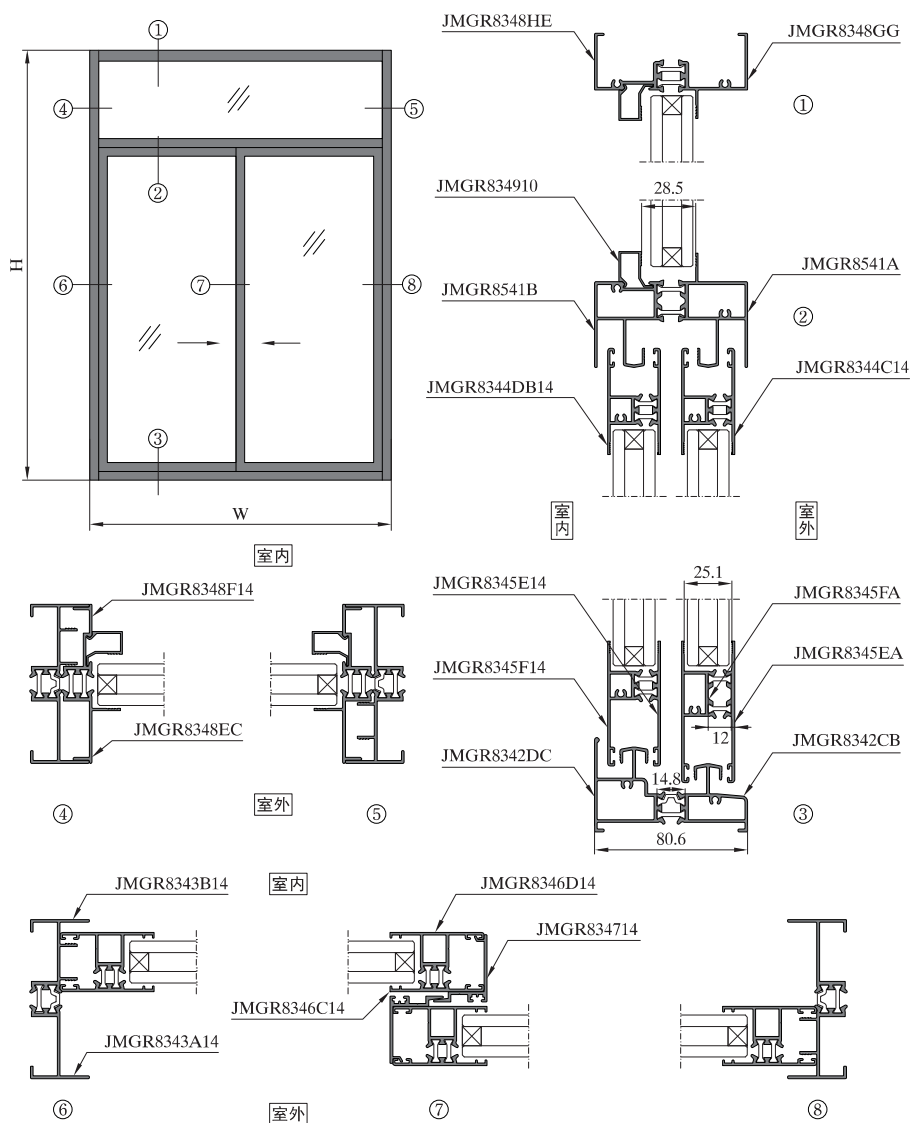

序号 S/N	型号理论重量 JMA Code & KG/M	型材图 Drawing	序号 S/N	型号理论重量 JMA Code & KG/M	型材图 Drawing	序号 S/N	型号理论重量 JMA Code & KG/M	型材图 Drawing
1	固上滑 JMGR8541A JMGR8541B 1.724kg/m		10	下方 JMGR8345EA JMGR8345FA 1.196kg/m		19	收口 JMGR8348K14 JMGR8348K14 0.553kg/m	
2	固上滑 JMGR8541C JMGR8541C 1.374kg/m		11	光企 JMGR8346C14 JMGR8346D14 0.918kg/m		20	压线 JMGR834910 0.168kg/m	
3	下滑 JMGR8342L14 JMGR8342J14 1.488kg/m		12	光企 JMGR8346E14 JMGR8346F14 1.097kg/m		21	反插板 JMGR8549A JMGR8348ZB14 0.679kg/m	
4	下滑 JMGR8342DC JMGR8342CB 1.629kg/m		13	勾企 JMGR834714 0.323kg/m		22	拼料 JMGR8349P JMGR8349P 0.963kg/m	
5	固下滑 JMGR8342HC JMGR8342R14 1.744kg/m		14	勾企 JMGR8347A14 0.334kg/m		23	转角 GR80A18D JMGR8548A 1.596kg/m	
6	边封 JMGR8343A14 JMGR8343B14 1.037kg/m		15	固定框 JMGR8348HE JMGR8348GG 1.039kg/m		24	转角 JMGR6040FA14 JMGR6040GA14 1.927kg/m	
7	边封 JMGR8343C14 JMGR8343D14 1.278kg/m		16	边封插板 JMGR8348EC JMGR8348F14 0.81kg/m		25		
8	上方 JMGR8344C14 JMGR8344DB14 0.949kg/m		17	中柱 JMGR8348CC JMGR8348D14 1.328kg/m		26		
9	下方 JMGR8345E14 JMGR8345F14 1.037kg/m		18	中柱 JMGR8348CD JMGR8348DE 1.57kg/m		27		

图中所示型材截面、装配、编号、尺寸及重量仅供参考。如有疑问，请向本公司查询。
Information above just for your reference. Please contact us if you have any questions, Thank you!

图中所示型材截面、装配、编号、尺寸及重量仅供参考。如有疑问，请向本公司查询。
Information above just for your reference. Please contact us if you have any questions, Thank you!

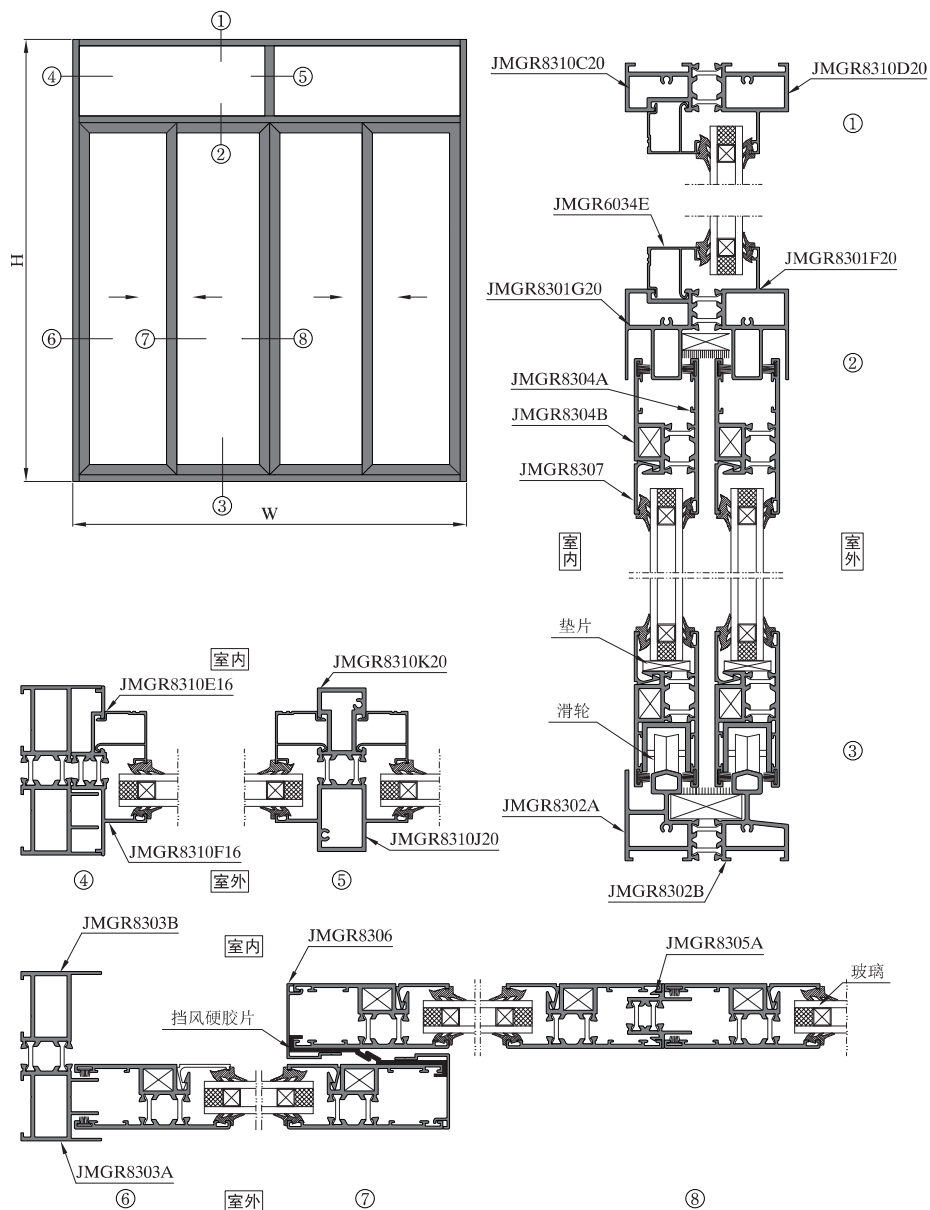

序号 S/N	型号理论重量 JMA Code & KG/M	型材图 Drawing	序号 S/N	型号理论重量 JMA Code & KG/M	型材图 Drawing	序号 S/N	型号理论重量 JMA Code & KG/M	型材图 Drawing
1	上滑 JMGR8301A JMGR8301A 2.231kg/m		10	上方 JMGR8304D JMGR8304E JMGR8307B14 1.522kg/m		19	勾企 JMGR8306 0.261kg/m	
2	上滑 JMGR8301C16 JMGR8301D16 2.195kg/m		11	收口 JMGR8305A JMGR8305A 0.646kg/m		20	勾企 JMGR8306A12 0.267kg/m	
3	上滑 JMGR8301F20 JMGR8301G20 2.341kg/m		12	上固 JMGR8310C20 JMGR8310D20 1.758kg/m		21	角码 JMGR9013 2.051kg/m	
4	下滑 JMGR8302A JMGR8302B 2.311kg/m		13	上固 JMGR8310C16 JMGR8310D16 1.560kg/m		22		
5	下滑 JMGR8302A16 JMGR8302B16 1.961kg/m		14	中柱 JMGR8310K20 JMGR8310J20 1.868kg/m		23		
6	边封 JMGR8303A JMGR8303B 1.827kg/m		15	只适用于 四扇推拉门 JMGR8310E16 JMGR8310F16 0.919kg/m		24		
7	边封 JMGR8303A16 JMGR8303B16 1.594kg/m		16	压线 JMGR8307 0.160kg/m		25		
8	上方 JMGR8304A JMGR8304B 1.405kg/m		17	压线 JMGR6034YA 0.210kg/m		26		
9	上方 JMGR8304A16 JMGR8304B16 1.280kg/m		18	压线 JMGR6034E 0.254kg/m		27		

图中所示型材截面、装配、编号、尺寸及重量仅供参考。如有疑问，请向本公司查询。
Information above just for your reference. Please contact us if you have any questions, Thank you!

图中所示型材截面、装配、编号、尺寸及重量仅供参考。如有疑问，请向本公司查询。
Information above just for your reference. Please contact us if you have any questions, Thank you!

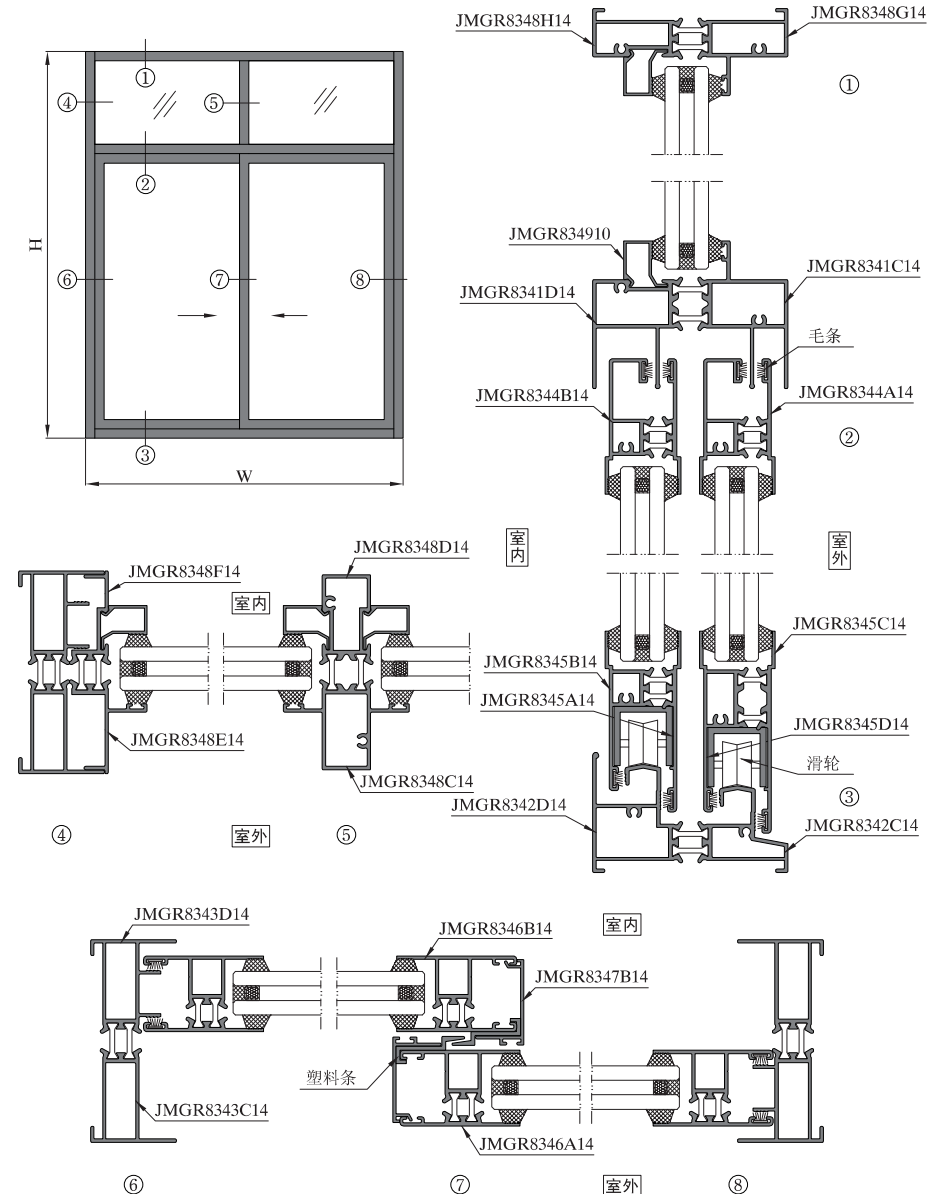
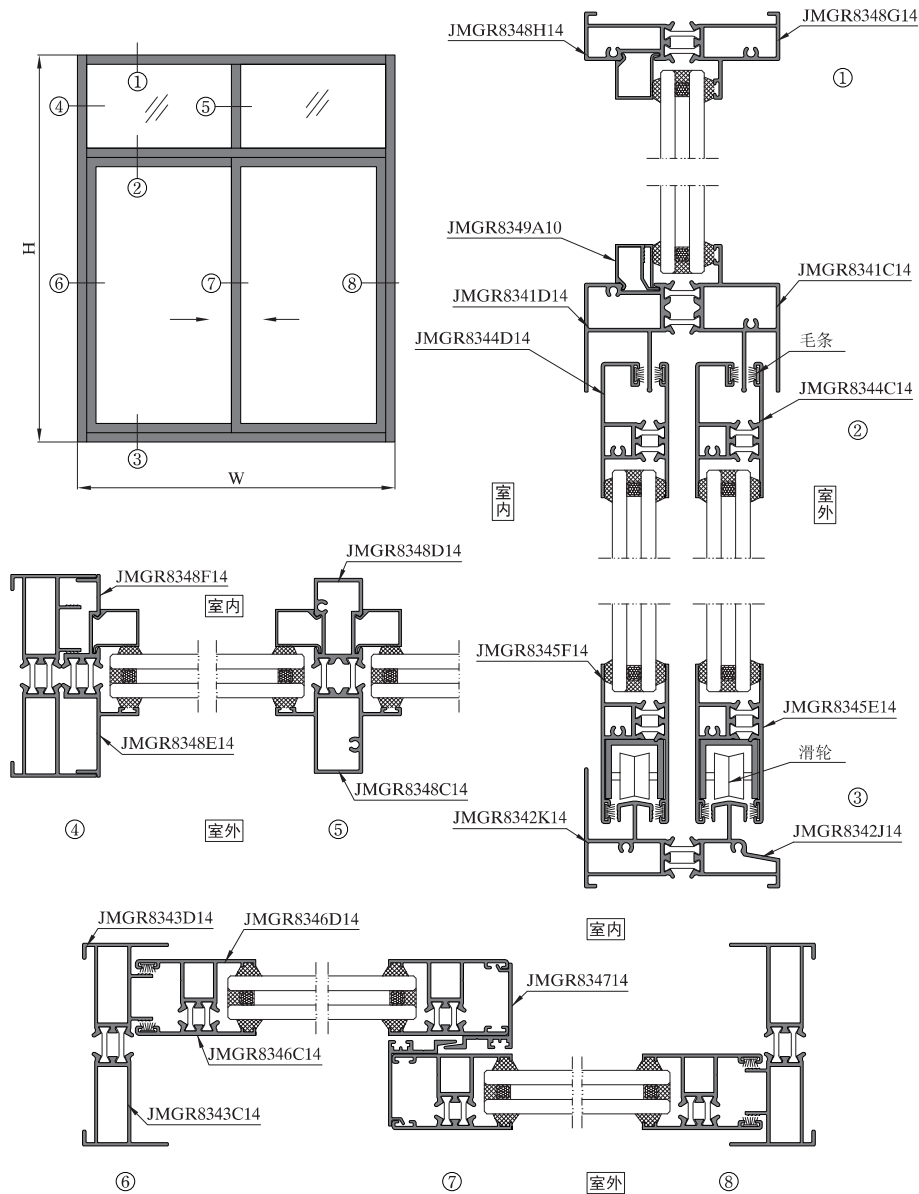

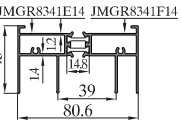
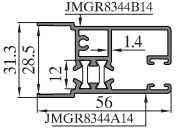
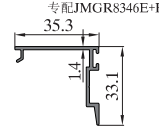
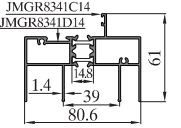
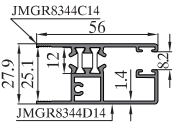
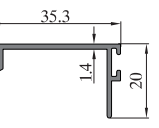
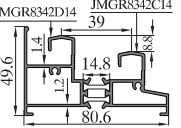
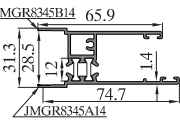
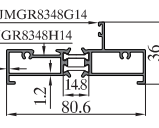
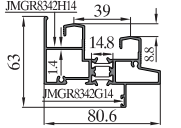
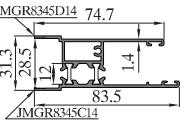
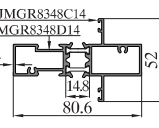
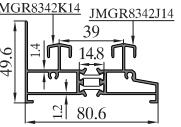
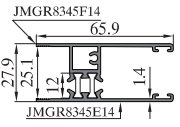
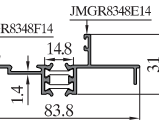
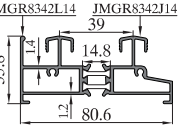
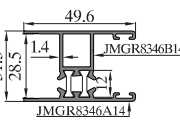
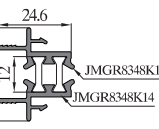
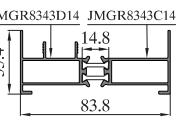
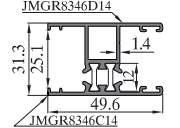
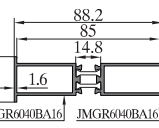
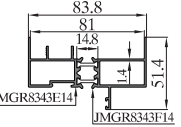
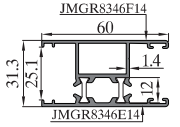
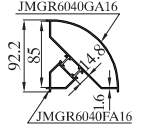
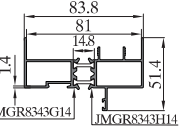
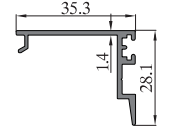
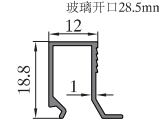
序号 S/N	型号理论重量 JMA Code & KG/M	型材图 Drawing	序号 S/N	型号理论重量 JMA Code & KG/M	型材图 Drawing	序号 S/N	型号理论重量 JMA Code & KG/M	型材图 Drawing
1	上滑 JMGR8341E14 JMGR8341F14 1.512kg/m		10	上方 JMGR8344A14 JMGR8344B14 1.037kg/m		19	勾企 JMGR8347A14 0.334kg/m	
2	上滑 JMGR8341C14 JMGR8341D14 1.700kg/m		11	上方 JMGR8344C14 JMGR8344D14 1.022kg/m		20	勾企 JMGR8347B14 0.254kg/m	
3	下滑 JMGR8342C14 JMGR8342D14 1.562kg/m		12	下方 JMGR8345A14 JMGR8345B14 1.078kg/m		21	上固 JMGR8348H14 JMGR8348G14 1.201kg/m	
4	下滑 JMGR8342H14 JMGR8342G14 1.718kg/m		13	下方 JMGR8345C14 JMGR8345D14 1.236kg/m		22	中柱 JMGR8348C14 JMGR8348D14 1.402kg/m	
5	下滑 JMGR8342K14 JMGR8342J14 1.523kg/m		14	下方 JMGR8345E14 JMGR8345F14 1.024kg/m		23	反插板 JMGR8348E14 JMGR8348F14 0.846kg/m	
6	下滑 JMGR8342L14 JMGR8342I14 1.472kg/m		15	光企 JMGR8346A14 JMGR8346B14 0.881kg/m		24	收口 JMGR8348K14 JMGR8348K14 0.542kg/m	
7	边封 JMGR8343C14 JMGR8343D14 1.261kg/m		16	光企 JMGR8346C14 JMGR8346D14 0.905kg/m		25	拼管 JMGR6040BA16 1.333kg/m	
8	边封 JMGR8343E14 JMGR8343F14 1.449kg/m		17	光企 JMGR8346E14 JMGR8346F14 1.084kg/m		26	转角 JMGR6040GA16 JMGR6040FA16 2.067kg/m	
9	边封 JMGR8343G14 JMGR8343H14 1.449kg/m		18	勾企 JMGR8347I4 0.323kg/m		27	压线 JMGR8349I0 0.168kg/m	

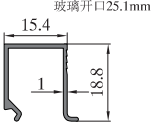
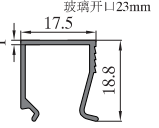
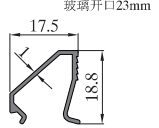
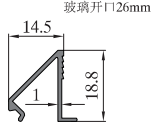
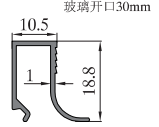
序号 S/N	型号理论重量 JMA Code & KG/M	型材图 Drawing	序号 S/N	型号理论重量 JMA Code & KG/M	型材图 Drawing	序号 S/N	型号理论重量 JMA Code & KG/M	型材图 Drawing
28	压线 JMGR8349A10 0.162kg/m		37			46		
29	压线 JMGR8349B10 0.178kg/m		38			47		
30	压线 JMGR8349BA 0.159kg/m		39			48		
31	压线 JMGR8349C10 0.151kg/m		40			49		
32	压线 JMGR8349D10 0.164kg/m		41			50		
33			42			51		
34			43			52		
35			44			53		
36			45			54		

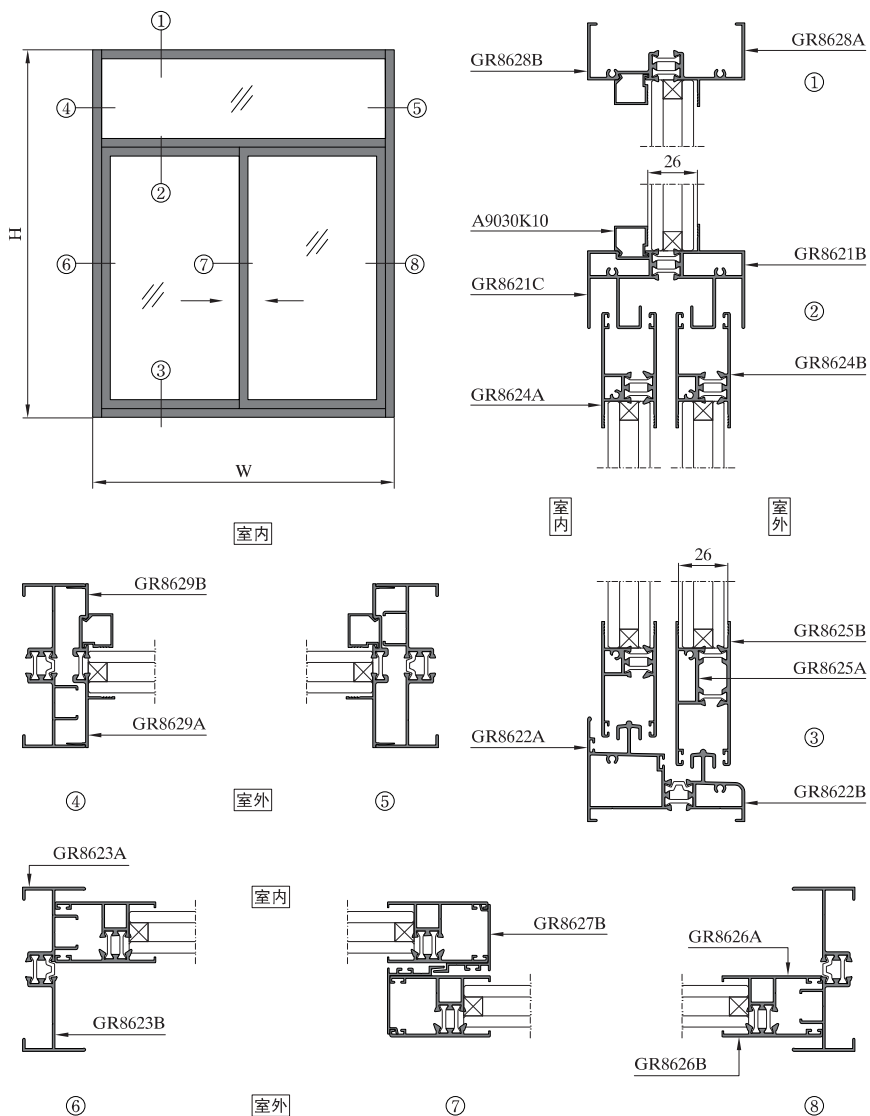

序号 S/N	型号理论重量 JMA Code & KG/M	型材图 Drawing	序号 S/N	型号理论重量 JMA Code & KG/M	型材图 Drawing	序号 S/N	型号理论重量 JMA Code & KG/M	型材图 Drawing
1	上滑 GR8621A GR8621A 1.436kg/m		10	固定框 GR8628A GR8628B 1.021kg/m		19		
2	固上滑 GR8621B GR8621C 1.716kg/m		11	边封插板 GR8629A GR8629B 0.592kg/m		20		
3	下滑 GR8622A GR8622B 1.702kg/m		12	中柱 GR8628C GR8628D 1.395kg/m		21		
4	固下滑 GR8622C GR8622D 1.88kg/m		13	收口 GR8629E 0.221kg/m		22		
5	边封 GR8623A GR8623B 1.056kg/m		14	压线 A9030K10 0.161kg/m		23		开口26mm
6	上方 GR8624A GR8624B 1.123kg/m		15	工字 GR8628E GR8628E 0.716kg/m		24		
7	下方 GR8625A GR8625B 1.226kg/m		16	转角 GR80A18D GR8628G 1.628kg/m		25		
8	光企 GR8626A GR8626B 0.923kg/m		17	转角 JMGR8048E GR8628F 2.157kg/m		26		
9	勾企盖板 GR8627B 0.272kg/m		18			27		

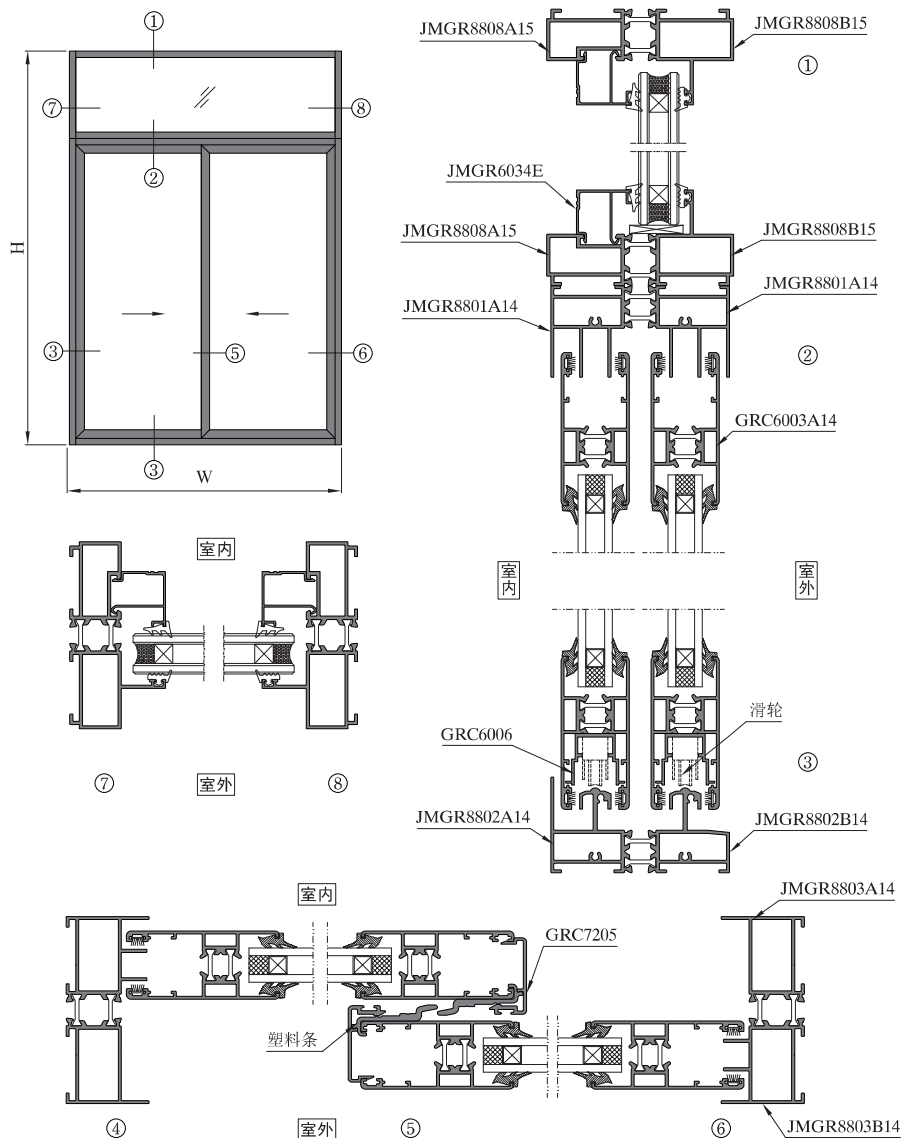

序号 S/N	型号理论重量 JMA Code & KG/M	型材图 Drawing	序号 S/N	型号理论重量 JMA Code & KG/M	型材图 Drawing	序号 S/N	型号理论重量 JMA Code & KG/M	型材图 Drawing
1	上滑 JMGR8801A14 JMGR8801A14 1.801kg/m		10	上方 GRC6003A14 GRC6003A14 1.259kg/m		19	压线 JMGR6034E 0.254kg/m	
2	上滑 JMGR8801A20 JMGR8801A20 2.227kg/m		11	上方 GRC6003A20 GRC6003A20 1.527kg/m		20	压线 JMGR8805A10 0.306kg/m	
3	上滑 JMGR8801B14 JMGR8801B14 1.819kg/m		12	中柱 JMGR6032P JMGR6032Q 1.318kg/m		21	压线 JMGR880510 0.311kg/m	
4	上滑 JMGR8801B20 JMGR8801B20 2.238kg/m		13	上固 JMGR8808A15 JMGR8808B15 1.511kg/m		22		
5	下滑 JMGR8802A14 JMGR8802B14 1.846kg/m		14	上固 JMGR8808C15 JMGR8808D15 1.549kg/m		23		
6	下滑 JMGR8802A20 JMGR8802B20 2.341kg/m		15	上固 JMGR8808E15 JMGR8808F15 1.572kg/m		24		
7	下滑 JMGR8802C14 JMGR8802D14 1.857kg/m		16	勾企 GRC7205 0.327kg/m		25		
8	边封 JMGR8803A14 JMGR8803B14 1.517kg/m		17	GRC7206 0.311kg/m		26		
9	边封 JMGR8803A20 JMGR8803B20 1.915kg/m		18	GRC6006 0.287kg/m		27		

图中所示型材截面、装配、编号、尺寸及重量仅供参考。如有疑问，请向本公司查询。
Information above just for your reference. Please contact us if you have any questions, Thank you!

图中所示型材截面、装配、编号、尺寸及重量仅供参考。如有疑问，请向本公司查询。
Information above just for your reference. Please contact us if you have any questions, Thank you!

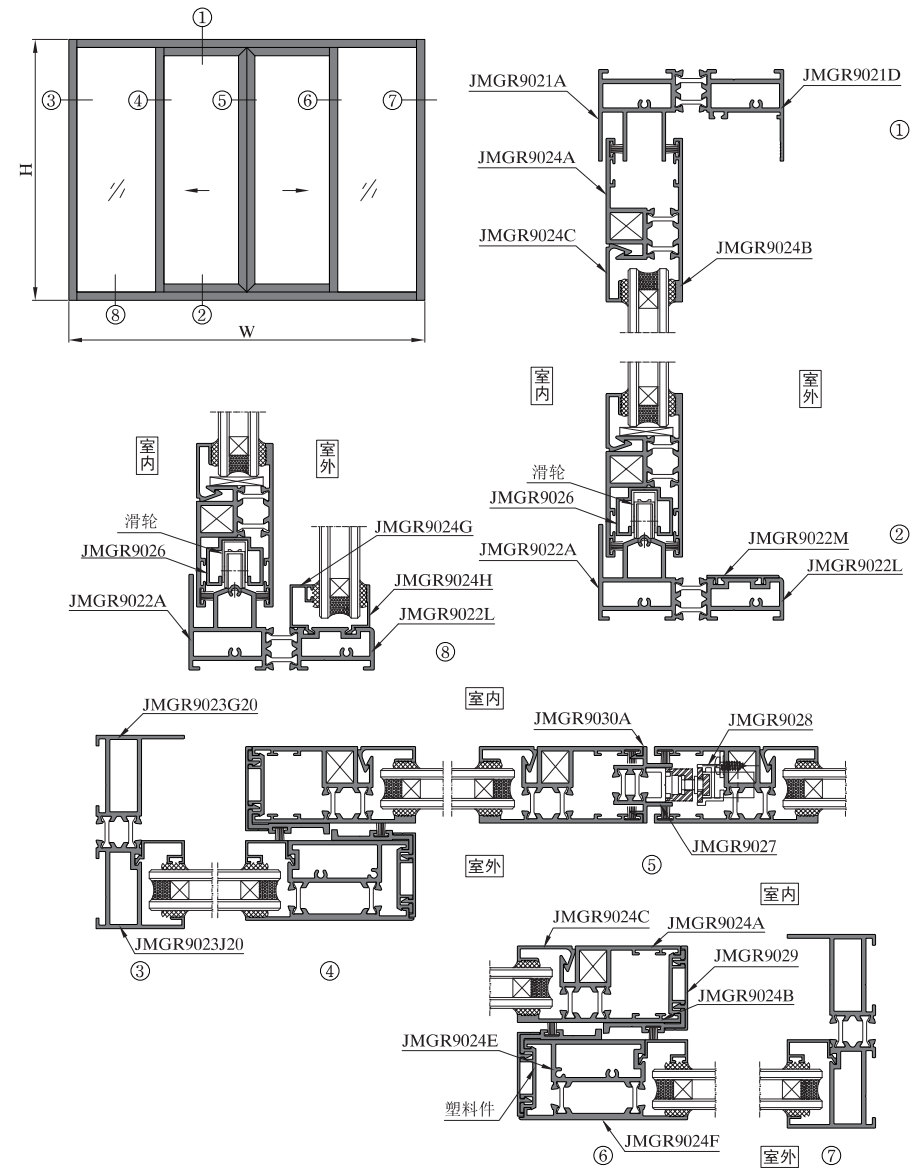
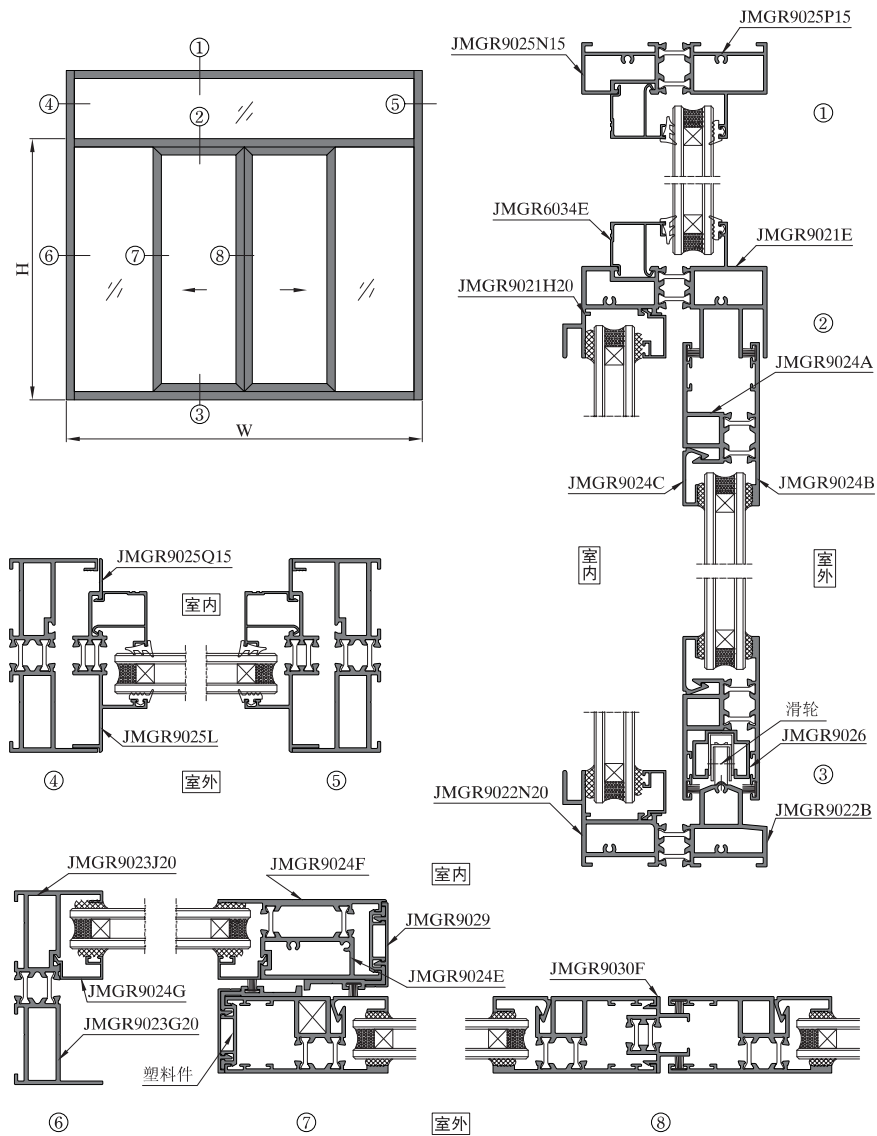

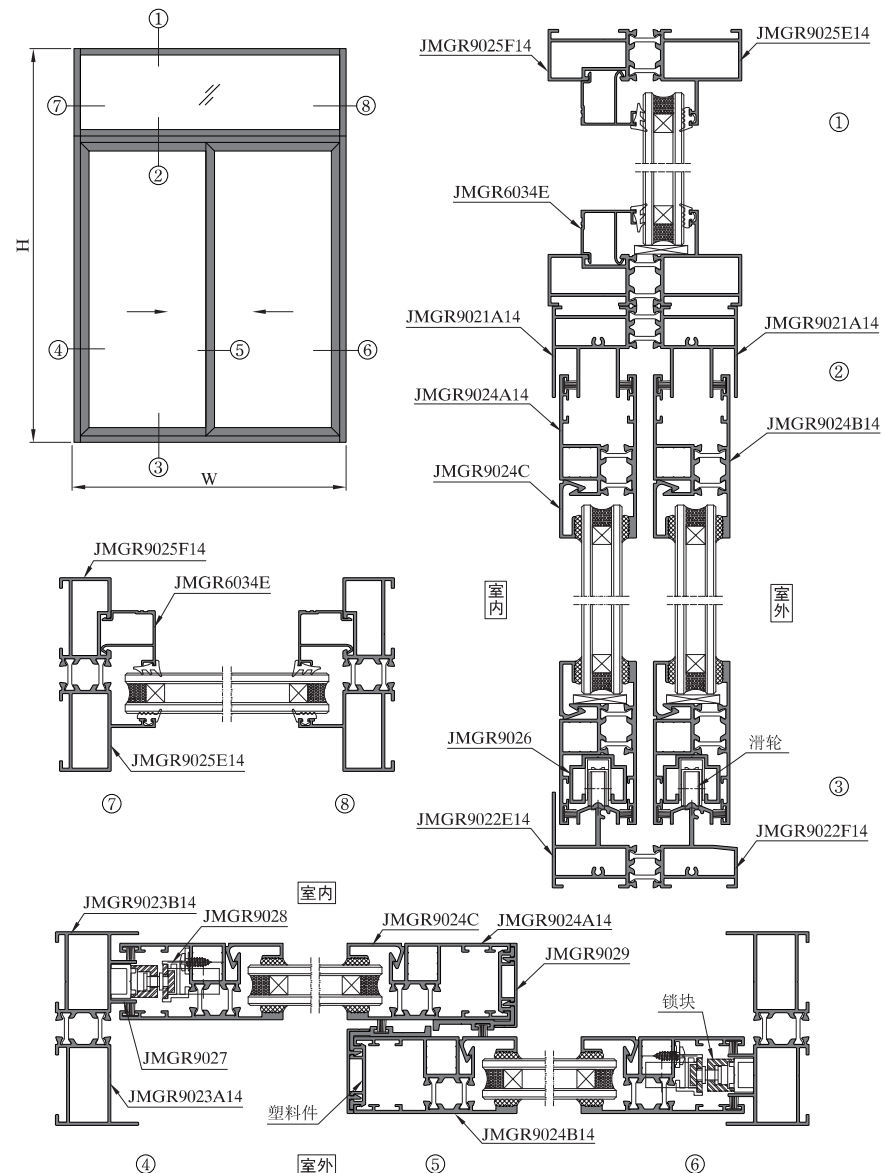
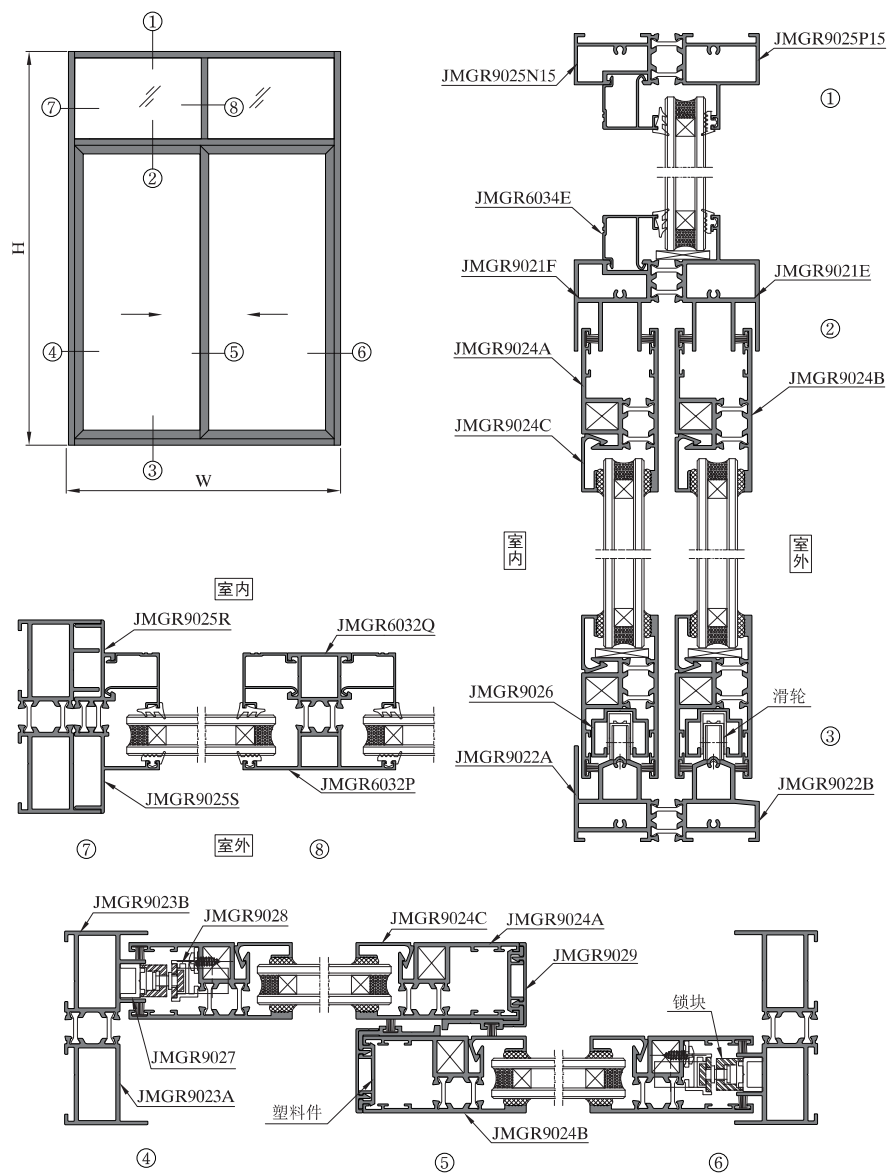

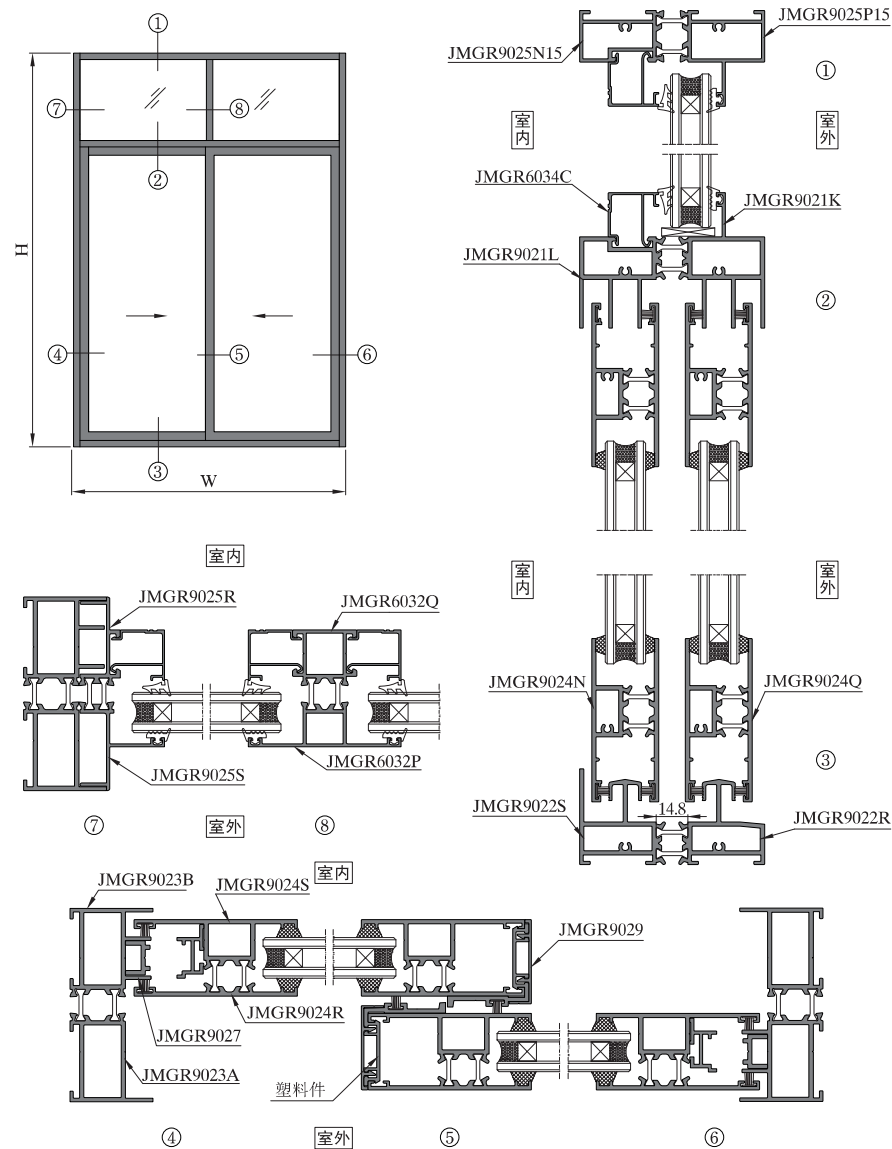
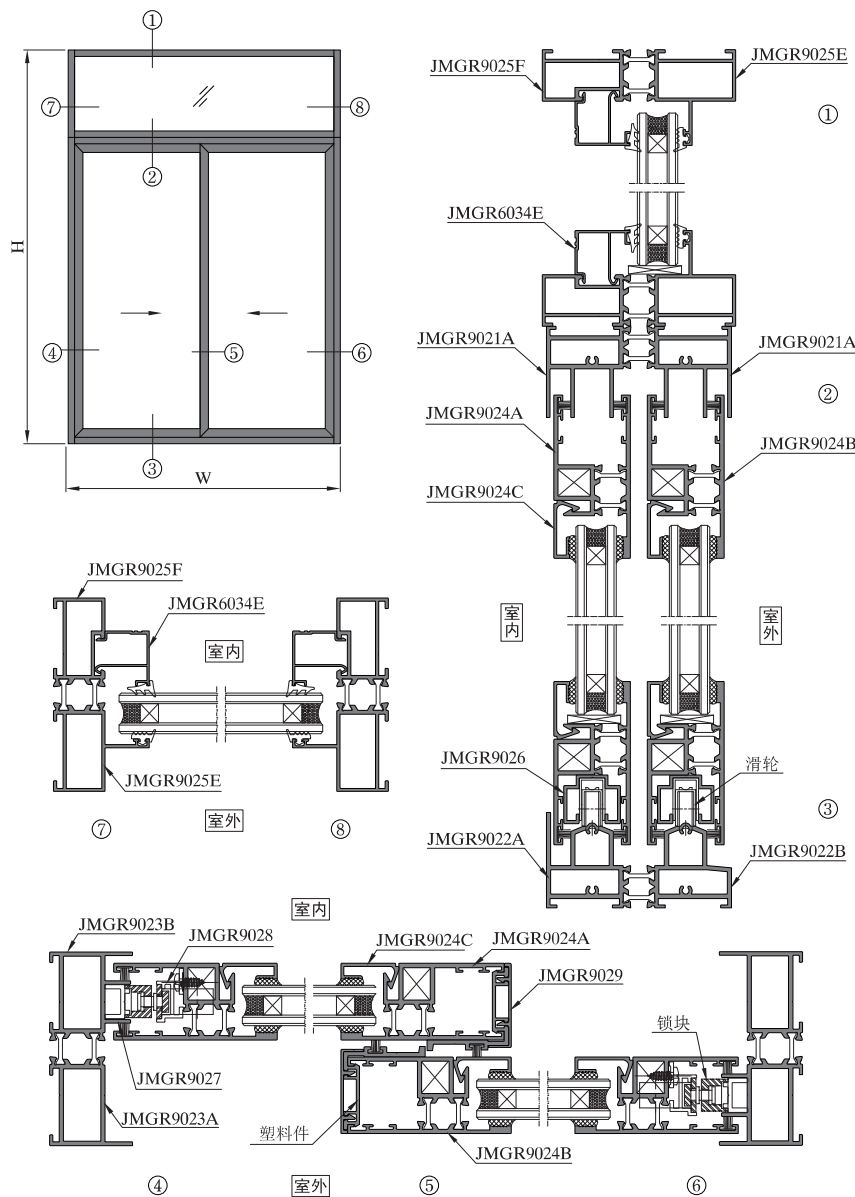

图中所示型材截面、装配、编号、尺寸及重量仅供参考。如有疑问，请向本公司查询。
Information above just for your reference. Please contact us if you have any questions, Thank you!

图中所示型材截面、装配、编号、尺寸及重量仅供参考。如有疑问，请向本公司查询。
Information above just for your reference. Please contact us if you have any questions, Thank you!

序号 S/N	型号理论重量 JMA Code & KG/M	型材图 Drawing	序号 S/N	型号理论重量 JMA Code & KG/M	型材图 Drawing	序号 S/N	型号理论重量 JMA Code & KG/M	型材图 Drawing
1	上滑 JMGR9021A JMGR9021A 2.262kg/m		10	上滑 JMGR9021M JMGR9021M 2.262kg/m		19	下滑 JMGR9022A JMGR9022L 2.110kg/m	
2	上滑 JMGR9021B JMGR9021B 2.394kg/m		11	上滑 JMGR9021K JMGR9021L 2.399kg/m		20	下滑 JMGR9022N20 JMGR9022B 2.203kg/m	
3	固上滑 JMGR9021E JMGR9021G20 2.519kg/m		12	下滑 JMGR9022R JMGR9022S 2.215kg/m		21	边封 JMGR9023A JMGR9023B 1.949kg/m	
4	上滑 JMGR9021A14 JMGR9021A14 1.830kg/m		13	下滑 JMGR9022A JMGR9022B 2.327kg/m		22	边封 JMGR9023H20 JMGR9023G20 1.944kg/m	
5	上滑 JMGR9021B14 JMGR9021B14 1.925kg/m		14	下滑 JMGR9022B JMGR9022C 2.460kg/m		23	边封 JMGR9023G20 JMGR9023J20 1.862kg/m	
6	上滑 JMGR9021E14 JMGR9021G14 2.024kg/m		15	下滑 JMGR9022B14 JMGR9022C14 1.908kg/m		24	边封 JMGR9023A14 JMGR9023B14 1.545kg/m	
7	上滑 JMGR9021A JMGR9021D 2.071kg/m		16	下滑 JMGR9022P14 JMGR9022Q14 1.965kg/m		25	边封 JMGR9023H14 JMGR9023G14 1.551kg/m	
8	上滑 JMGR9021E JMGR9021H20 2.340kg/m		17	下滑 JMGR9022E14 JMGR9022F14 1.892kg/m		26	上方 JMGR9024A JMGR9024B 1.490kg/m	
9	上滑 JMGR9021E JMGR9021F 2.386kg/m		18	下滑 JMGR9022H20 JMGR9022G20 2.425kg/m		27	上方 JMGR9024A14 JMGR9024B14 1.296kg/m	

序号 S/N	型号理论重量 JMA Code & KG/M	型材图 Drawing	序号 S/N	型号理论重量 JMA Code & KG/M	型材图 Drawing	序号 S/N	型号理论重量 JMA Code & KG/M	型材图 Drawing
28	上方 JMGR9024E JMGR9024F 1.720kg/m		37	上固 JMGR9025C14 JMGR9025D14 1.565kg/m		46	转角 JMGR6040C JMGR6040D 3.406kg/m	
29	上方 JMGR9024N JMGR9024Q 1.514kg/m		38	上固 JMGR9025E14 JMGR9025F14 1.461kg/m		47	JMGR9022M 0.140kg/m	
30	光企 JMGR9024R JMGR9024S 1.558kg/m		39	中柱 JMGR9025G JMGR9025H 1.637kg/m		48	JMGR9026 0.355kg/m	
31	中柱 JMGR6032P JMGR6032Q 1.318kg/m		40	插板 JMGR9025L JMGR9025Q15 0.908kg/m		49	JMGR9027 0.204kg/m	
32	上固 JMGR9025P15 JMGR9025N15 1.516kg/m		41	插板 JMGR9025L JMGR9025M 0.962kg/m		50	JMGR9028 0.258kg/m	
33	上固 JMGR9025A JMGR9025B 1.960kg/m		42	插板 JMGR9025R JMGR9025S 1.011kg/m		51	JMGR9028A 0.403kg/m	
34	上固 JMGR9025A14 JMGR9025B14 1.626kg/m		43	收口 JMGR9030A JMGR9030A 0.650kg/m		52	JMGR9028B 0.362kg/m	
35	上固 JMGR9025C JMGR9025D 1.960kg/m		44	收口 JMGR9030E JMGR9030E 0.732kg/m		53	JMGR9029 0.224kg/m	
36	上固 JMGR9025E JMGR9025F 1.538kg/m		45	收口 JMGR9030F JMGR9030F 0.680kg/m		54	JMGR9029A 0.378kg/m	

图中所示型材截面、装配、编号、尺寸及重量仅供参考。如有疑问，请向本公司查询。
Information above just for your reference. Please contact us if you have any questions, Thank you!

图中所示型材截面、装配、编号、尺寸及重量仅供参考。如有疑问，请向本公司查询。
Information above just for your reference. Please contact us if you have any questions, Thank you!

序号 S/N	型号理论重量 JMA Code & KG/M	型材图 Drawing	序号 S/N	型号理论重量 JMA Code & KG/M	型材图 Drawing	序号 S/N	型号理论重量 JMA Code & KG/M	型材图 Drawing
55	压线 JMGR9024C 0.220kg/m		64			73		
56	压线 JMGR9024W 0.226kg/m		65			74		
57	压线 JMGR9024G 0.173kg/m		66			75		
58	压线 JMGR9024H 0.118kg/m		67			76		
59	压线 JMGR6034E 0.254kg/m		68			77		
60	压线 JMGR6034YA 0.210kg/m		69			78		
61	角码 JM5004A 2.354kg/m		70			79		
62	角码 JMGR6517 2.224kg/m		71			80		
63			72			81		

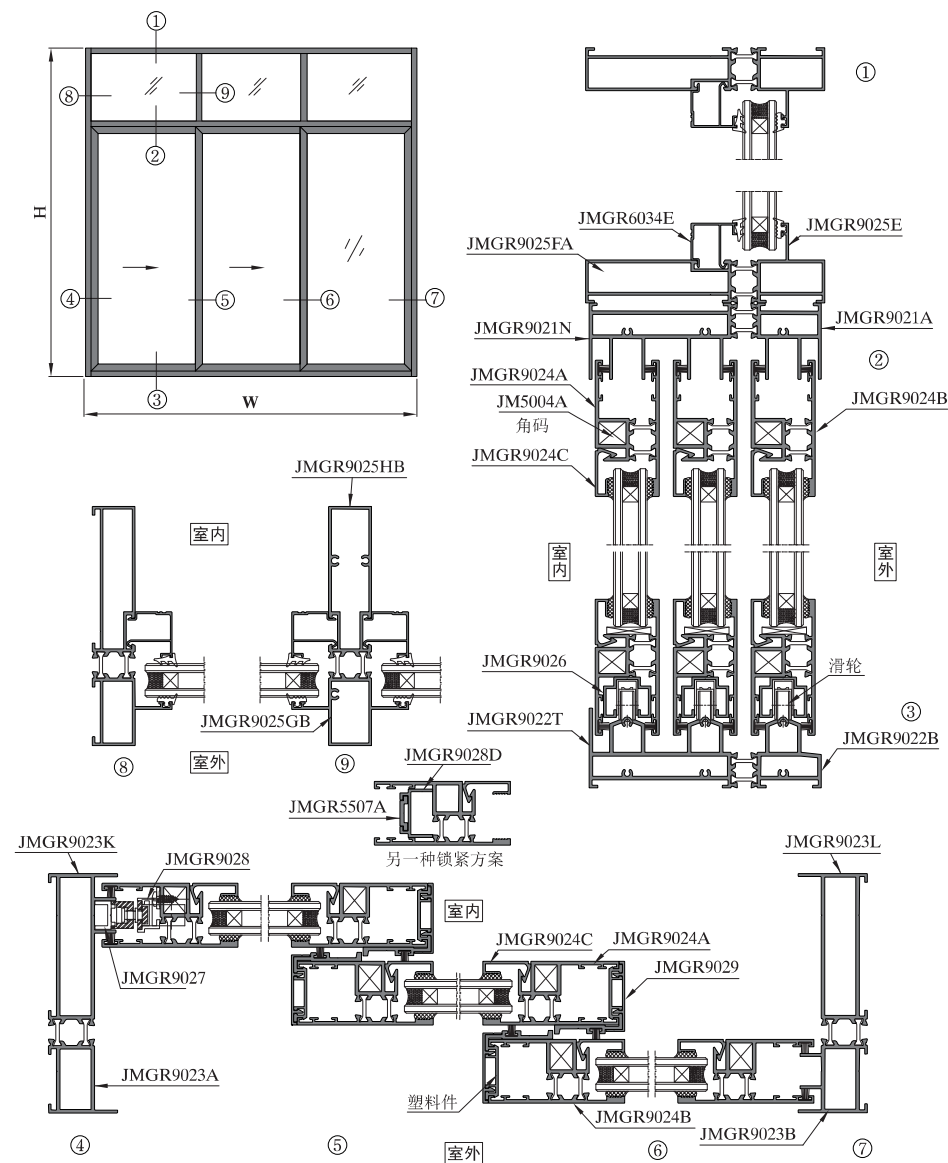

序号 S/N	型号理论重量 JMA Code & KG/M	型材图 Drawing	序号 S/N	型号理论重量 JMA Code & KG/M	型材图 Drawing	序号 S/N	型号理论重量 JMA Code & KG/M	型材图 Drawing
1	上滑 JMGR9021A JMGR9021N 3.040kg/m		10	压线 JMGR9024W 0.226kg/m		19	连杆 JMGR5507A 0.153kg/m	
2	下滑 JMGR9022B JMGR9022T 3.180kg/m		11	压线 JMGR6034E 0.254kg/m		20	角码 JM5004A 2.354kg/m	
3	边封 JMGR9023A JMGR9023K 2.465kg/m		12	压线 JMGR6034YA 0.210kg/m		21		
4	边封 JMGR9023B JMGR9023L 2.466kg/m		13	JMGR9026 0.355kg/m		22		
5	上方 JMGR9024A JMGR9024B 1.490kg/m		14	JMGR9027 0.204kg/m		23		
6	上固 JMGR9025E JMGR9025FA 1.925kg/m		15	JMGR9028 0.258kg/m		24		
7	中柱 JMGR9025GB JMGR9025HB 2.135kg/m		16	JMGR9028D 0.289kg/m		25		
8	收口 JMGR9030A JMGR9030A 0.650kg/m		17	JMGR9029 0.224kg/m		26		
9	压线 JMGR9024C 0.220kg/m		18	勾企扣条 JMGR9029A 0.378kg/m		27		

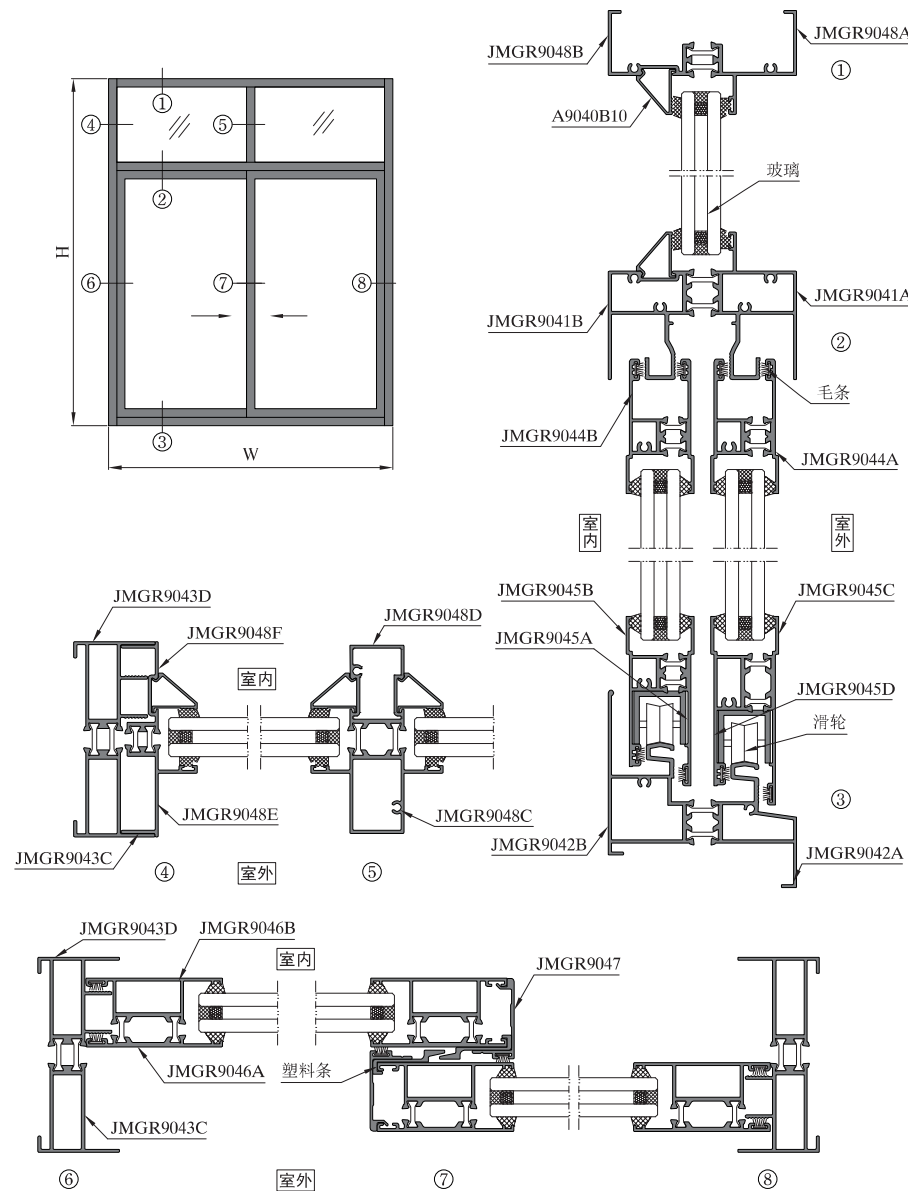

序号 S/N	型号理论重量 JMA Code & KG/M	型材图 Drawing	序号 S/N	型号理论重量 JMA Code & KG/M	型材图 Drawing	序号 S/N	型号理论重量 JMA Code & KG/M	型材图 Drawing
1	上滑 JMGR9041A JMGR9041B 2.187kg/m		10	上固 JMGR9048A JMGR9048B 1.109kg/m		19		
2	上滑 JMGR9041C JMGR9041D 1.948kg/m		11	中柱 JMGR9048C JMGR9048D 1.570kg/m		20		
3	下滑 JMGR9042A JMGR9042B 2.013kg/m		12	边封插板 JMGR9048F JMGR9048E 0.921kg/m		21		
4	带固下滑 JMGR9042C JMGR9042D 2.299kg/m		13	压线 A9040A10 0.160kg/m		22		
5	边封 JMGR9043D JMGR9043C 1.476kg/m		14	压线 A9040B10 0.152kg/m		23		
6	上方 JMGR9044A JMGR9044B 1.115kg/m		15	勾企扣条 JMGR9047 0.279kg/m		24		
7	下方 JMGR9045A JMGR9045B 1.211kg/m		16	下滑 JMGR9042B JMGR9042AB 1.952kg/m		25		
8	下方 JMGR9045C JMGR9045D 1.354kg/m		17			26		
9	光企 JMGR9046A JMGR9046B 1.175kg/m		18			27		

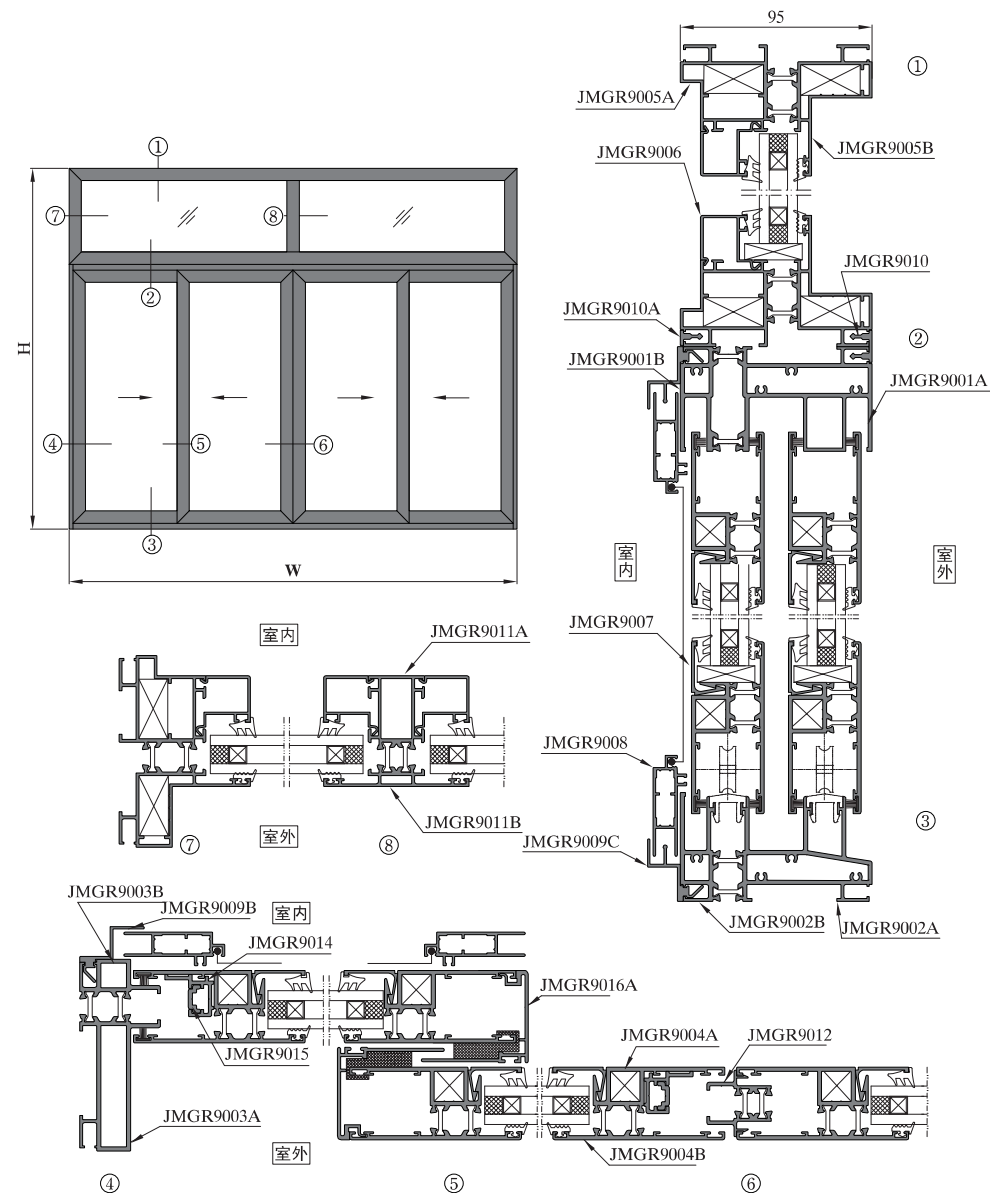

序号 S/N	型号理论重量 JMA Code & KG/M	型材图 Drawing	序号 S/N	型号理论重量 JMA Code & KG/M	型材图 Drawing	序号 S/N	型号理论重量 JMA Code & KG/M	型材图 Drawing
1	上滑 JMGR9001A JMGR9001B 2.938kg/m		10	扇料 JMGR9016B JMGR9004C14 JMGR9004B14 1.684kg/m		19	JMGR9009C 0.320kg/m	
2	上滑 JMGR9001B16 JMGR9001A16 2.692kg/m		11	扇料 JMGR9016B JMGR9004D14 JMGR9004A14 1.683kg/m		20	JMGR9010 0.188kg/m	
3	下滑 JMGR9002A JMGR9002B 2.743kg/m		12	JMGR9005A JMGR9005B 1.968kg/m		21	JMGR9010A 0.092kg/m	
4	下滑 JMGR9002A16 JMGR9002B16 2.445kg/m		13	压线 JMGR9006 0.322kg/m		22	JMGR9011A JMGR9011B 1.406kg/m	
5	边封 JMGR9003A JMGR9003B 1.957kg/m		14	压线 JMGR9007 0.187kg/m		23	JMGR9012 JMGR9012 0.659kg/m	
6	边封 JMGR9003A16 JMGR9003B16 1.724kg/m		15	纱窗 JMGR9008 0.496kg/m		24	JMGR9014 0.310kg/m	
7	扇料 JMGR9004A JMGR9004B 1.565kg/m		16	纱窗 JMGR9008A 0.521kg/m		25	连杆 JMGR9015 0.122kg/m	
8	扇料 JMGR9004A14 JMGR9004B14 1.352kg/m		17	纱窗 JMGR9008B 0.627kg/m		26	扣条 JMGR9016 0.593kg/m	
9	扇料 JMGR9004A18 JMGR9004B18 1.499kg/m		18	JMGR9009B 0.286kg/m		27	扣条 JMGR9016A 0.590kg/m	

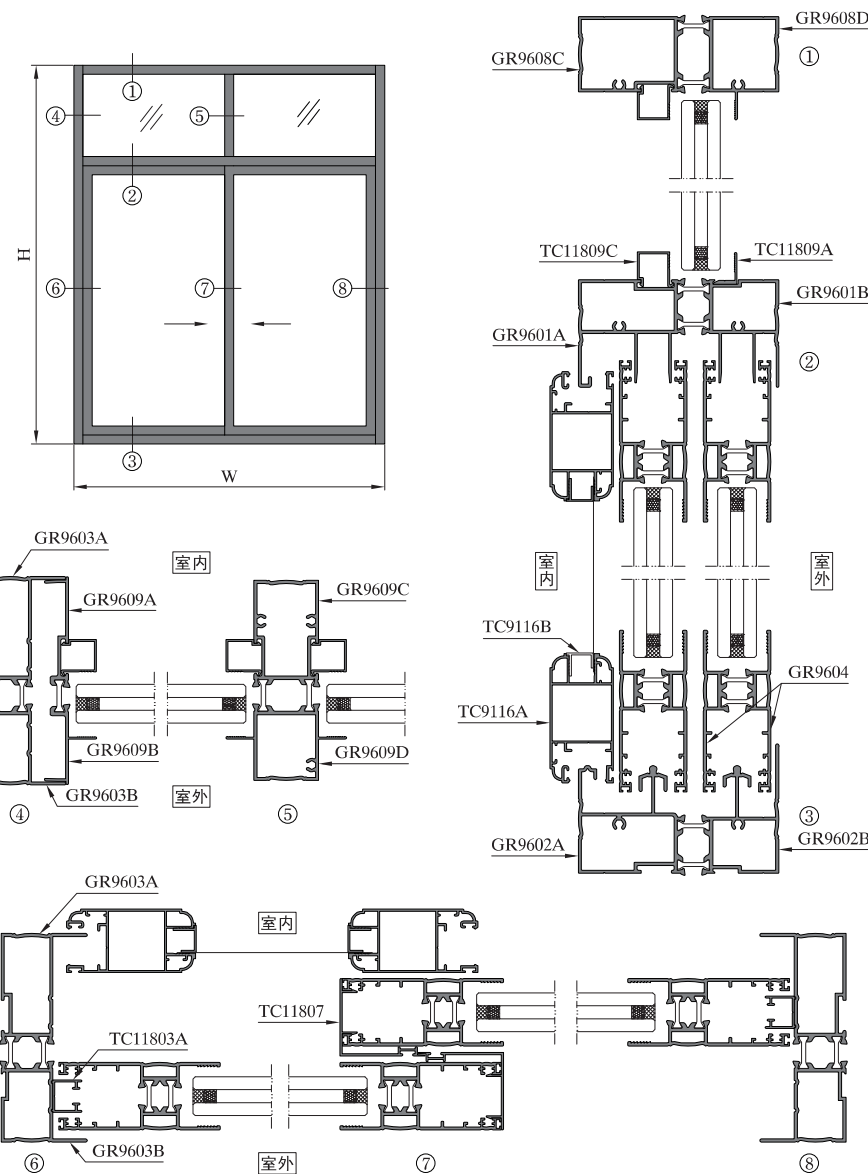

序号 S/N	型号理论重量 JMA Code & KG/M	型材图 Drawing	序号 S/N	型号理论重量 JMA Code & KG/M	型材图 Drawing	序号 S/N	型号理论重量 JMA Code & KG/M	型材图 Drawing
1	上滑 GR9601A GR9601B 1.923kg/m		10	插板 GR9609A GR9609B 0.664kg/m		19		
2	下滑 GR9602A GR9602B 2.116kg/m		11	中柱 GR9609C GR9609D 1.612kg/m		20		
3	下滑 GR9602A GR9602F 2.143kg/m		12	压线 TC11809C 0.13kg/m		21		
4	边封 GR9603A GR9603B 1.477kg/m		13	辅料 TC11809A 0.091kg/m		22		
5	扇料 GR9604 GR9604 1.264kg/m		14	辅料 TC11803A 0.138kg/m		23		
6	勾企扣条 TC11807 0.271kg/m		15			24		
7	纱窗 TC9116A 0.734kg/m		16			25		
8	辅料 TC9116B 0.078kg/m		17			26		
9	上固 GR9608C GR9608D 1.595kg/m		18			27		

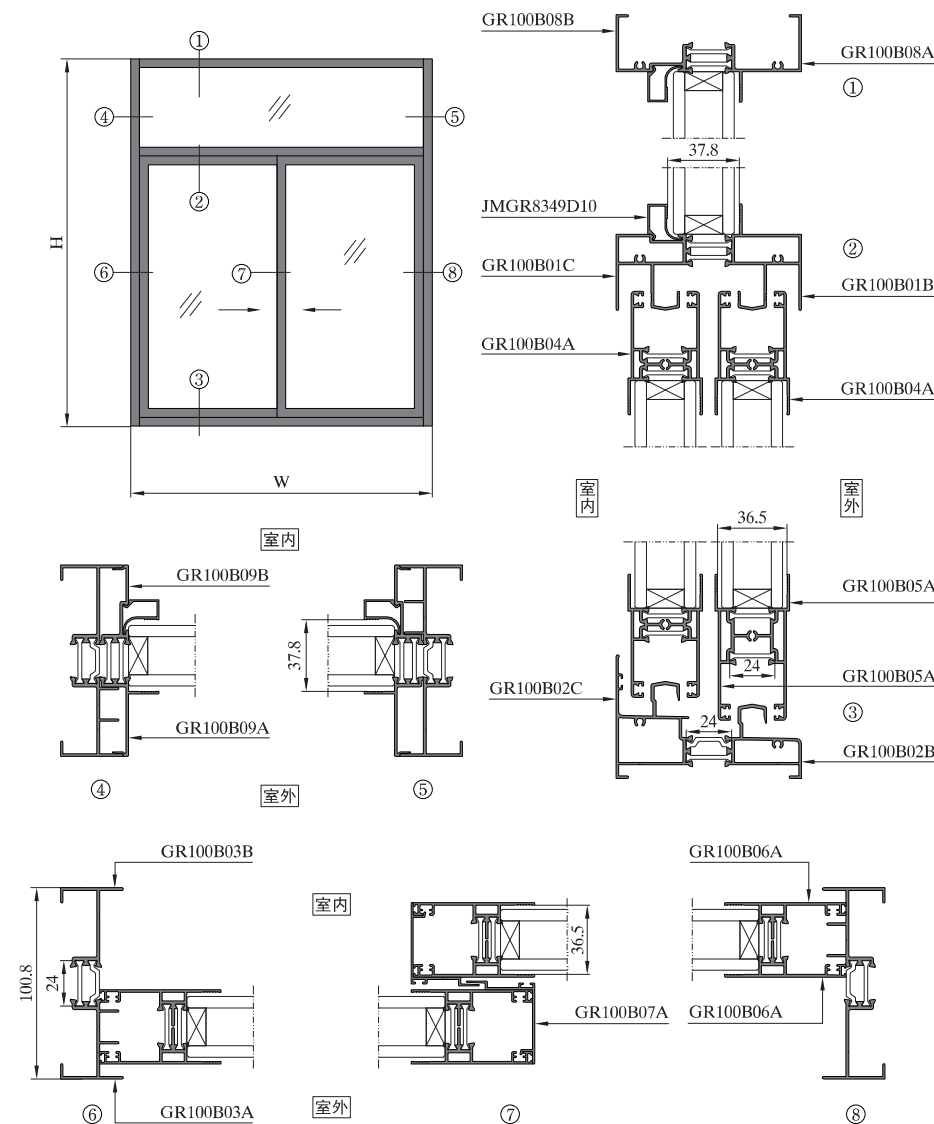

序号 S/N	型号理论重量 JMA Code & KG/M	型材图 Drawing	序号 S/N	型号理论重量 JMA Code & KG/M	型材图 Drawing	序号 S/N	型号理论重量 JMA Code & KG/M	型材图 Drawing
1	上滑 GR100B01A GR100B01A 1.476kg/m		10	勾企盖板 GR100B07A 0.309kg/m		19	转角 JMGR26387 JMGR31628 2.915kg/m	
2	固定框 GR100B01B GR100B01C 1.807kg/m		11	固定框 GR100B08A GR100B08B 1.139kg/m		20		
3	下滑 GR100B02A GR100B02B 1.615kg/m		12	反插板 GR100B08C GR100B08D 0.968kg/m		21		
4	下滑 GR100B02B GR100B02C 1.785kg/m		13	边封插板 GR100B09A GR100B09B 0.865kg/m		22		
5	固下滑 GR100B02D GR100B02E 1.972kg/m		14	中柱 GR100B09C GR100B09D 1.594kg/m		23		
6	边封 GR100B03A GR100B03B 1.118kg/m		15	收口 GR100B09E GR100B09E 0.563kg/m		24		
7	上方 GR100B04A GR100B04A 1.237kg/m		16	压线 JMGR834910 0.168kg/m		25		
8	下方 GR100B05A GR100B05A 1.448kg/m		17	压线 JMGR8349D10 0.164kg/m		26		
9	光企 GR100B06A GR100B06A 1.191kg/m		18	拼料 JMGR31630 JMGR31630 1.27kg/m		27		

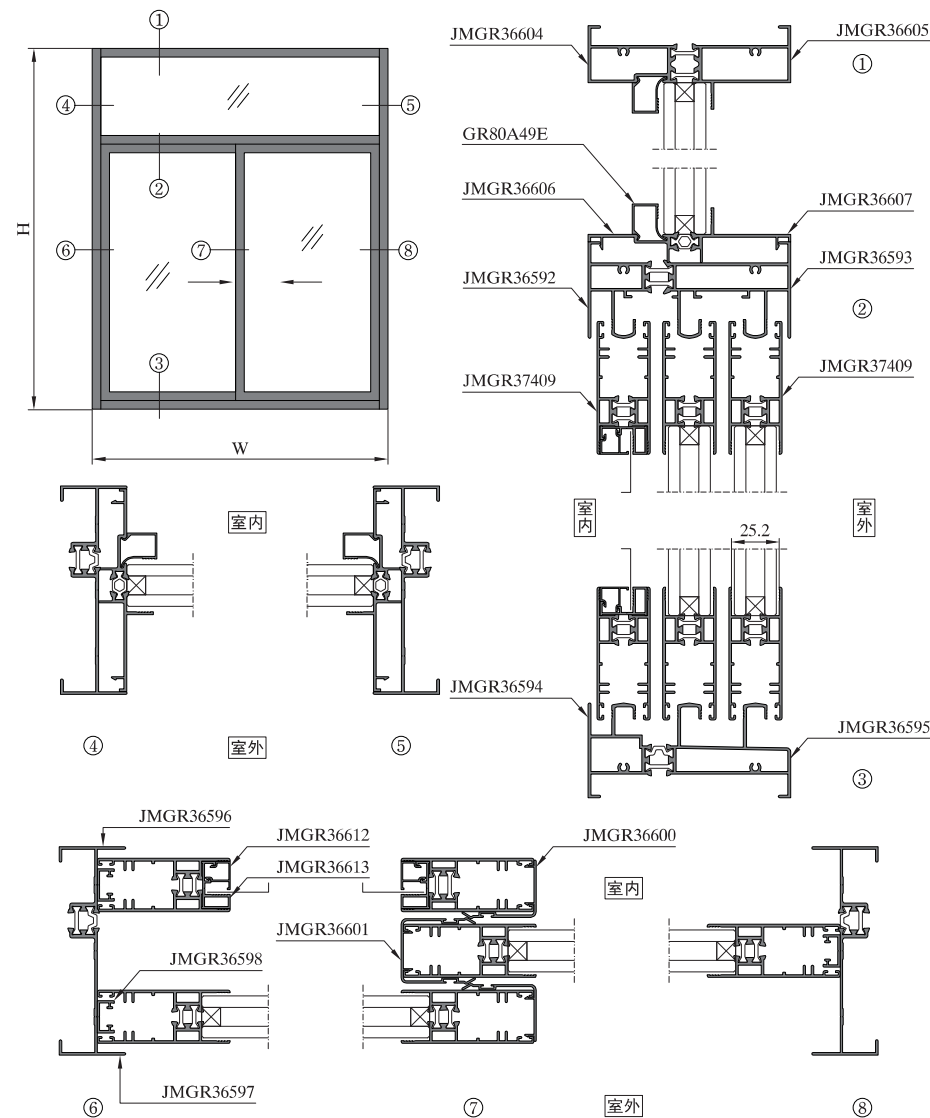

图中所示型材截面、装配、编号、尺寸及重量仅供参考。如有疑问，请向本公司查询。
Information above just for your reference. Please contact us if you have any questions, Thank you!

图中所示型材截面、装配、编号、尺寸及重量仅供参考。如有疑问，请向本公司查询。
Information above just for your reference. Please contact us if you have any questions, Thank you!

序号 S/N	型号理论重量 JMA Code & KG/M	型材图 Drawing	序号 S/N	型号理论重量 JMA Code & KG/M	型材图 Drawing	序号 S/N	型号理论重量 JMA Code & KG/M	型材图 Drawing
1	上滑 JMGR36592 JMGR36593 2.182kg/m		10	中柱 JMGR36610 JMGR36611 1.71kg/m		19		
2	下滑 JMGR36594 JMGR36595 2.026kg/m		11	纱窗压线 JMGR36612 0.096kg/m		20		
3	边封 JMGR36596 JMGR36597 1.109kg/m		12	纱窗 JMGR36613 0.217kg/m		21		
4	锁槽 JMGR36598 0.145kg/m		13	收口 JMGR36614 0.208kg/m		22		
5	扇料 JMGR37409 JMGR37409 1.117kg/m		14	压线 GR80A49E 0.151kg/m		23		
6	勾企盖板 JMGR36600 0.264kg/m		15			24		
7	勾企盖板 JMGR36601 0.411kg/m		16			25		
8	固定框 JMGR36604 JMGR36605 1.57kg/m		17			26		
9	插板 JMGR36606 JMGR36607 0.797kg/m		18			27		

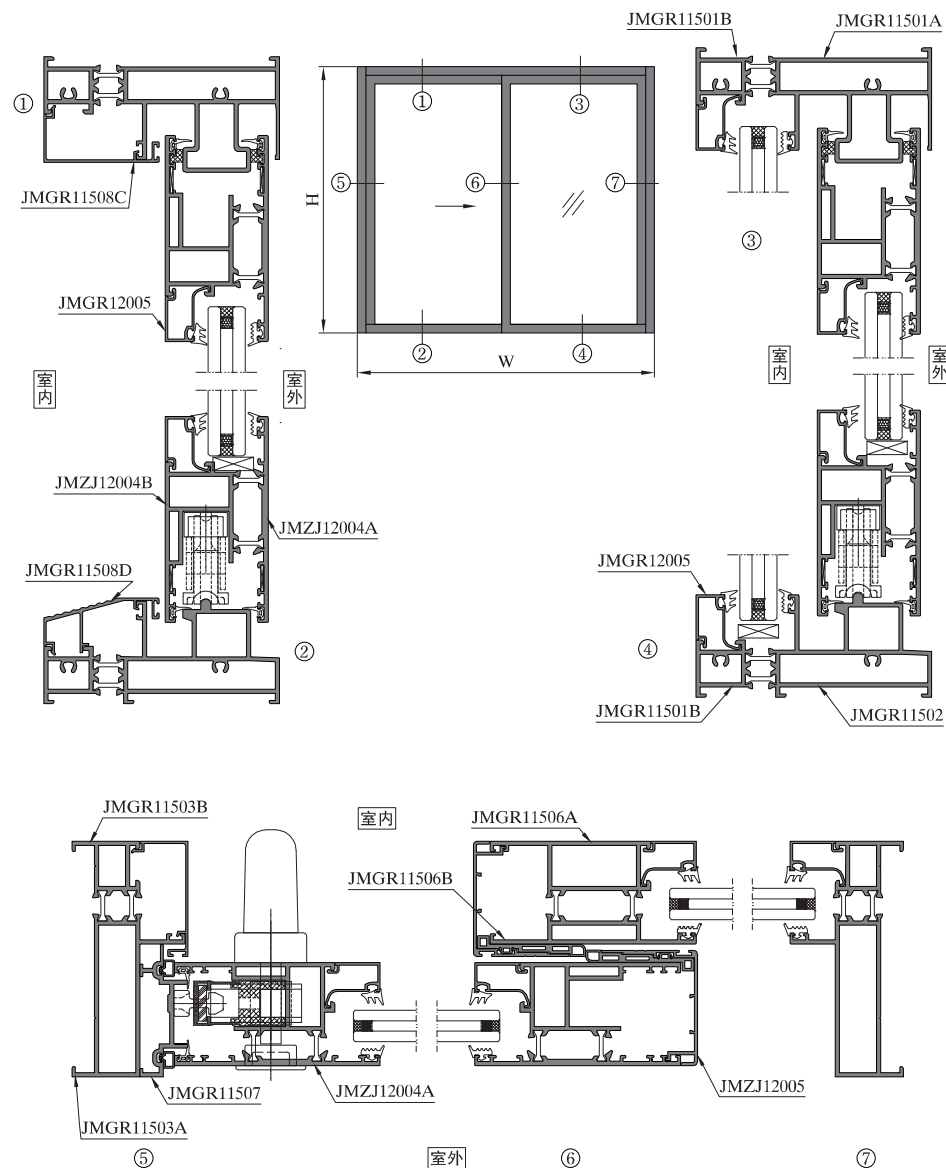

序号 S/N	型号理论重量 JMA Code & KG/M	型材图 Drawing	序号 S/N	型号理论重量 JMA Code & KG/M	型材图 Drawing	序号 S/N	型号理论重量 JMA Code & KG/M	型材图 Drawing
1	上滑 JMGR11501A JMGR11501B 2.980kg/m		10	JMGR11508D 0.483kg/m		19		
2	下滑 JMGR11502 JMGR11501B 2.807kg/m		11	JMZJ12005 0.594kg/m		20		
3	固定框 JMGR11503A JMGR11503B 2.179kg/m		12	压线 JMGR12005 0.262kg/m		21		
4	扇料 JMZJ12004A JMZJ12004B 2.391kg/m		13	中柱 JMGR11509A JMGR11509B 2.470kg/m		22		
5	扇料 JMGR11506A JMGR11506B 2.269kg/m		14	JMGR11508F 0.571kg/m		23		
6	收口 JMGR11508A JMGR11508B 0.786kg/m		15	JMGR11509 0.173kg/m		24		
7	JMGR11508C 0.363kg/m		16			25		
8	JMGR11508E 2.787kg/m		17			26		
9	JMGR11507 0.703kg/m		18			27		

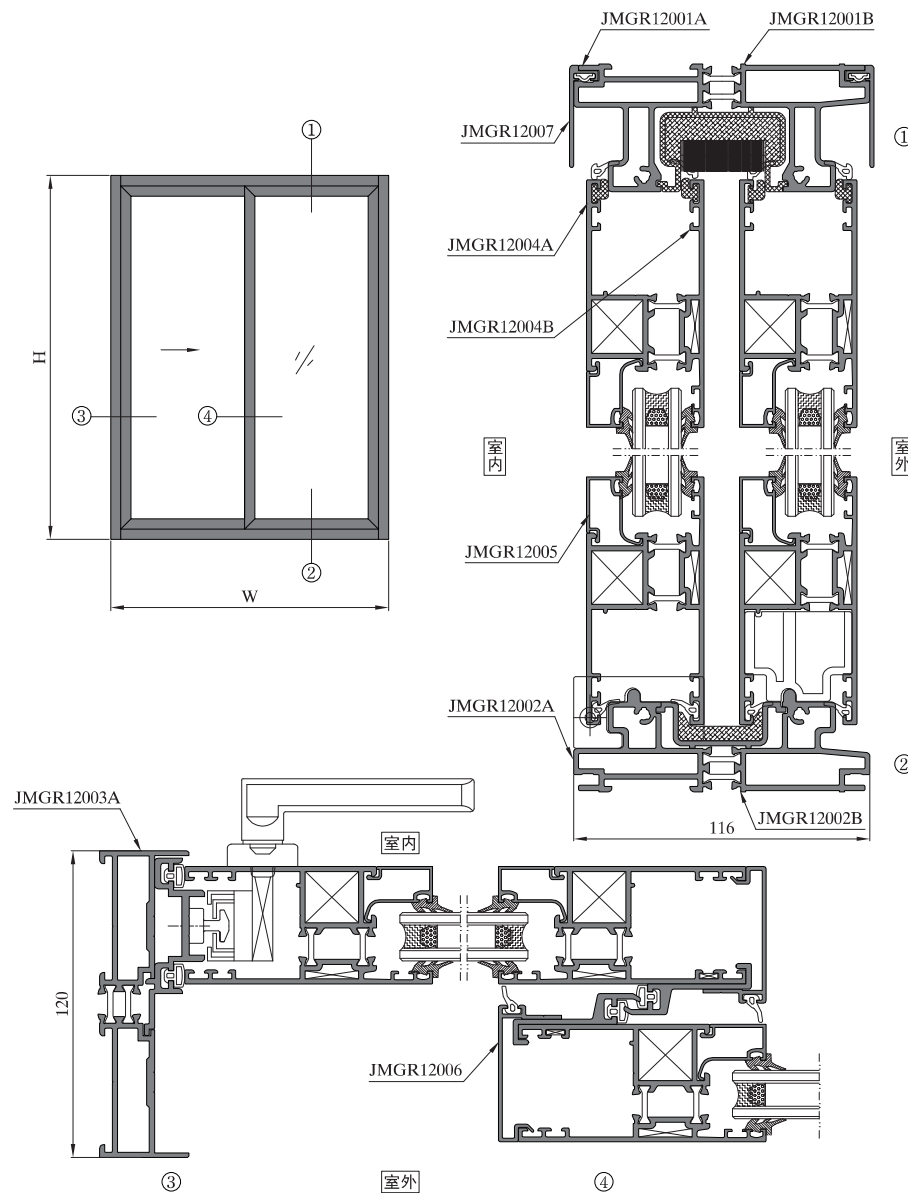

图中所示型材截面、装配、编号、尺寸及重量仅供参考。如有疑问，请向本公司查询。
Information above just for your reference. Please contact us if you have any questions, Thank you!

图中所示型材截面、装配、编号、尺寸及重量仅供参考。如有疑问，请向本公司查询。
Information above just for your reference. Please contact us if you have any questions, Thank you!

序号 S/N	型号理论重量 JMA Code & KG/M	型材图 Drawing	序号 S/N	型号理论重量 JMA Code & KG/M	型材图 Drawing	序号 S/N	型号理论重量 JMA Code & KG/M	型材图 Drawing
1	上滑 JMGR12001A JMGR12001B 3.053kg/m		10	JMGR12006 0.437kg/m		19		
2	下滑 JMGR12002A JMGR12002B 2.778kg/m		11	JMGR12007 0.242kg/m		20		
3	边封 JMGR12003A JMGR12003A 2.205kg/m		12	收口 JMGR12008A JMGR12008A 0.922kg/m		21		
4	扇料 JMGR12004A JMGR12004B 2.090kg/m		13	角码 JMGR5505D 4.125kg/m		22		
5	压线 JMGR12005 0.262kg/m		14			23		
6	压线 JMGR12005A 0.220kg/m		15			24		
7	压线 JMGR12005B 0.238kg/m		16			25		
8	压线 JMGR12005C 0.231kg/m		17			26		
9	压线 JMGR12005D 0.260kg/m		18			27		

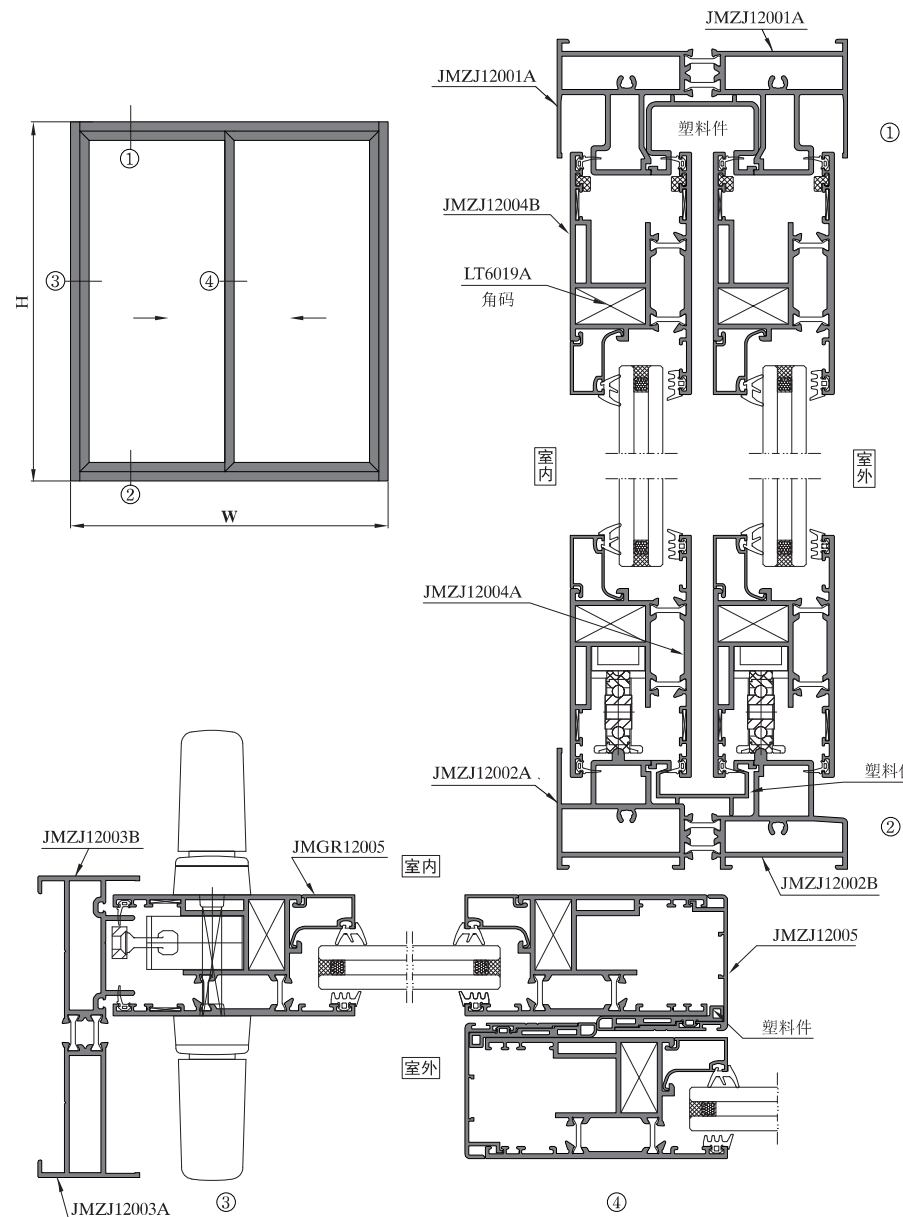

图中所示型材截面、装配、编号、尺寸及重量仅供参考。如有疑问，请向本公司查询。
Information above just for your reference. Please contact us if you have any questions, Thank you!

图中所示型材截面、装配、编号、尺寸及重量仅供参考。如有疑问，请向本公司查询。
Information above just for your reference. Please contact us if you have any questions, Thank you!

序号 S/N	型号理论重量 JMA Code & KG/M	型材图 Drawing	序号 S/N	型号理论重量 JMA Code & KG/M	型材图 Drawing	序号 S/N	型号理论重量 JMA Code & KG/M	型材图 Drawing
1	上滑 JMZJ12001A JMZJ12001A 3.387kg/m		10	压线 JMGR12005B 0.238kg/m		19		
2	带固上滑 JMZJ12001B JMZJ12001C 3.984kg/m		11	压线 JMGR12005C 0.231kg/m		20		
3	下滑 JMZJ12002A JMZJ12002B 3.131kg/m		12	压线 JMGR12005D 0.260kg/m		21		
4	下滑 JMZJ12002C JMZJ12002D 2.641kg/m		13	压线 JMGR12005E 0.252kg/m		22		
5	边封 JMZJ12003A JMZJ12003B 2.354kg/m		14	JMZJ12007A JMZJ12007B 2.459kg/m		23		
6	扇料 JMZJ12004A JMZJ12004B 2.391kg/m		15	边封插板 JMZJ12007C JMZJ12007D 1.466kg/m		24		
7	扇料 JMZJ12004B JMZJ12004C 3.819kg/m		16	角码 LT6019A 2.507kg/m		25		
8	压线 JMGR12005 0.262kg/m		17	扣条 JMZJ12005 0.594kg/m		26		
9	压线 JMGR12005A 0.220kg/m		18	收口 JMZJ12006 0.740kg/m		27		

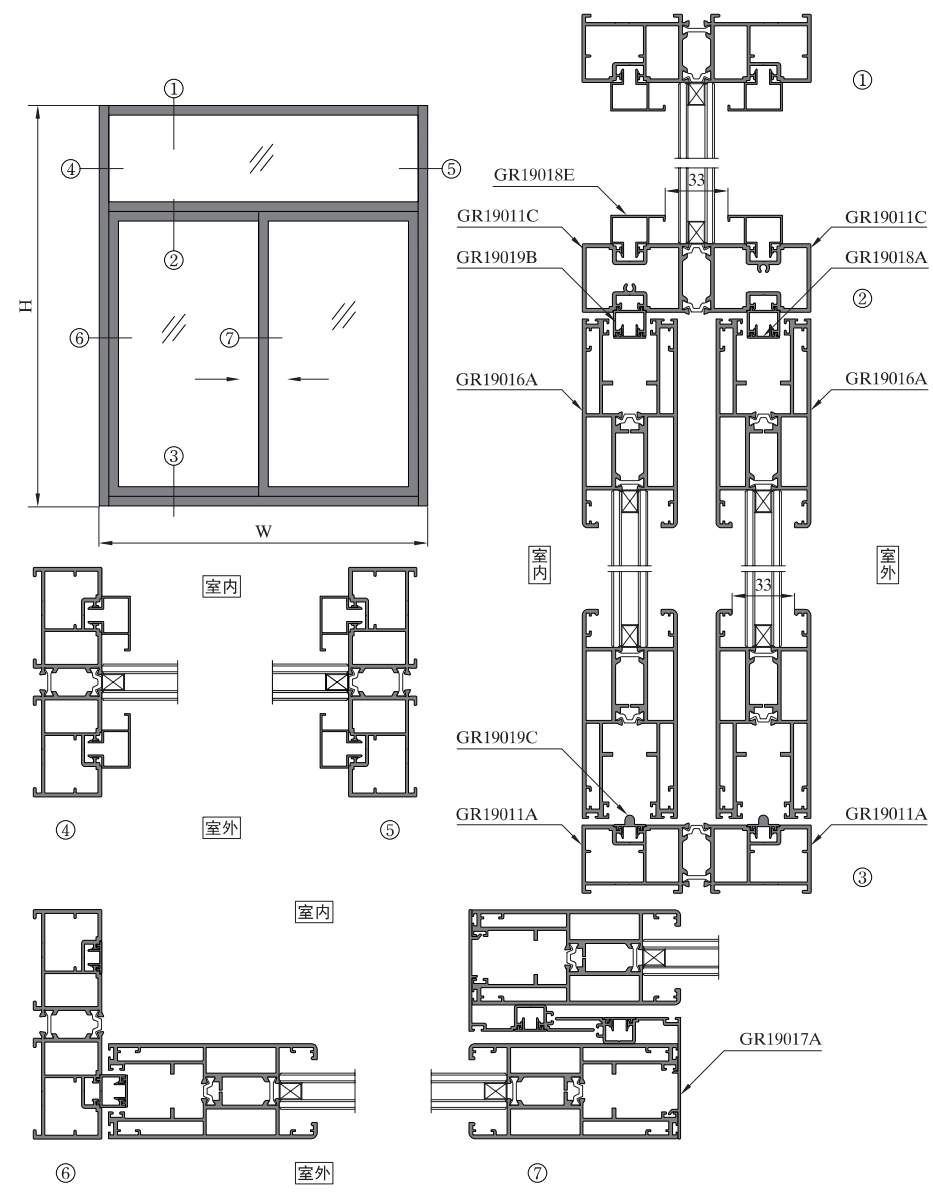

序号 S/N	型号理论重量 JMA Code & KG/M	型材图 Drawing	序号 S/N	型号理论重量 JMA Code & KG/M	型材图 Drawing	序号 S/N	型号理论重量 JMA Code & KG/M	型材图 Drawing
1	边框 GR19011A GR19011A T=2 2.568kg/m		8	纱中横 GR19016D T=1.4 1.782kg/m		17	锁槽/轮槽 GR19018D T=1.2 0.457kg/m	
2	边框 GR19011A GR19011B T=2 3.479kg/m		9	纱压线 GR19018B T=1.4 0.231kg/m		18	锁槽/轮槽 GR19018C 0.377kg/m	
			10	匀企盖板 GR19017A T=1.4 0.738kg/m		19	压线 GR19018E T=1 0.244kg/m	
3	中框 GR19011C GR19011C T=2 2.823kg/m		11	双匀企盖板 GR19017B T=1.4 1.227kg/m		20	收口 TM120B68 T=1.2 0.346kg/m	
4	中框 GR19011C GR19011D T=2 3.932kg/m		12	滑道头 GR19019C 0.165kg/m		21		
			13	滑道槽 GR19019B T=1.2 0.191kg/m		22		
5	扇料 GR19016A GR19016A T=2 3.223kg/m		14	轨道槽 GR19019 0.125kg/m		23		
6	扇料 GR19016B GR19016B T=2 3.352kg/m		15	封盖 GR19018A T=1 0.09kg/m		24		
7	纱扇 GR19016C T=1.4 2.014kg/m		16	副框 GR19018 T=2 1.103kg/m		25		

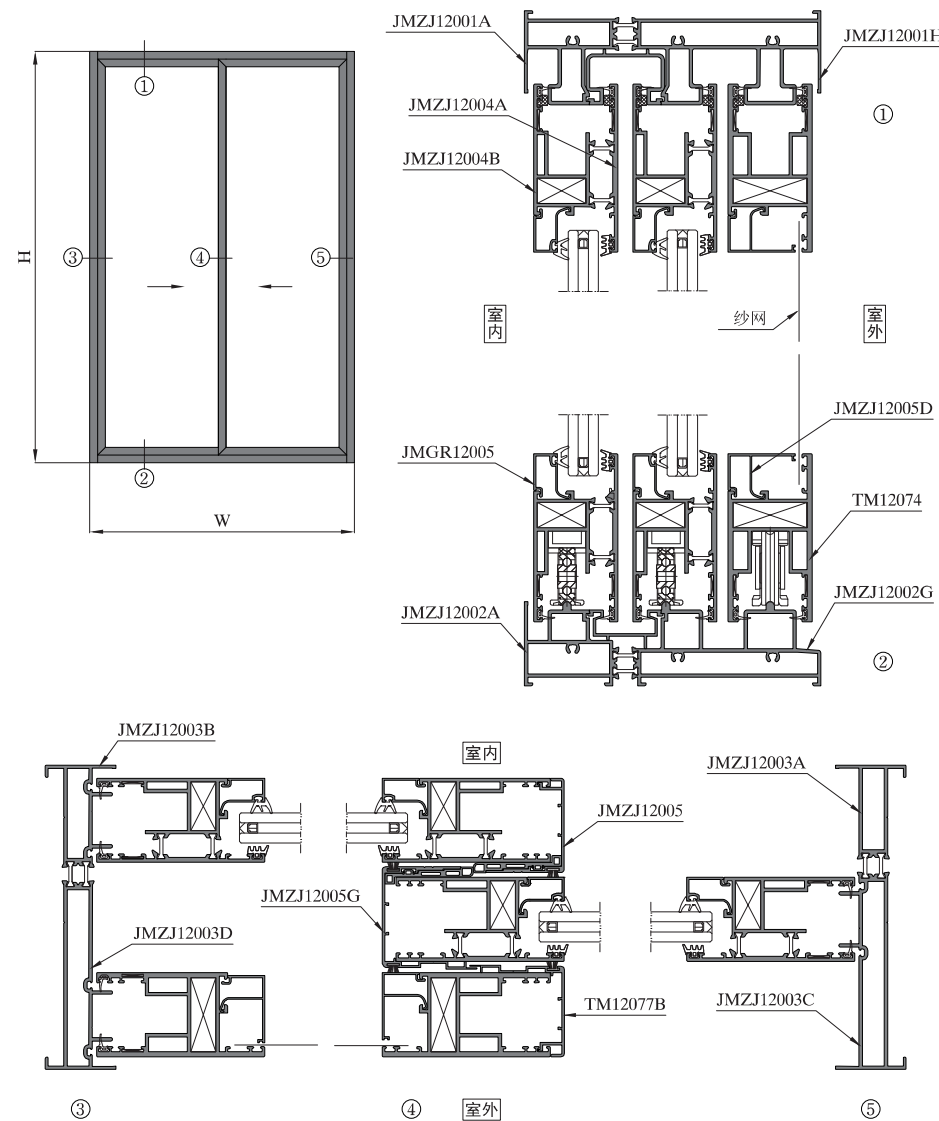

序号 S/N	型号理论重量 JMA Code & KG/M	型材图 Drawing	序号 S/N	型号理论重量 JMA Code & KG/M	型材图 Drawing	序号 S/N	型号理论重量 JMA Code & KG/M	型材图 Drawing
1	上滑 JMZJ12001A JMZJ12001H 4.741kg/m		10	纱扇压线 JMZJ12005D 0.343kg/m		19		
2	下滑 JMZJ12002A JMZJ12002G 4.345kg/m		11	角码 LT6019A 2.507kg/m		20		
3	边封 JMZJ12003A JMZJ12003C 3.015kg/m		12	勾企 JMZJ12005G 0.755kg/m		21		
4	边封 JMZJ12003B JMZJ12003D 3.217kg/m		13	勾企 TM12077B 0.598kg/m		22		
5	扇料 JMZJ12004A JMZJ12004B 2.391kg/m		14			23		
6	纱扇 TM12074 2.689kg/m		15			24		
7	勾企 JMZJ12005 0.594kg/m		16			25		
8	勾企 JMZJ12005E 0.757kg/m		17			26		
9	扇压线 JMGR12005 0.261kg/m		18			27		

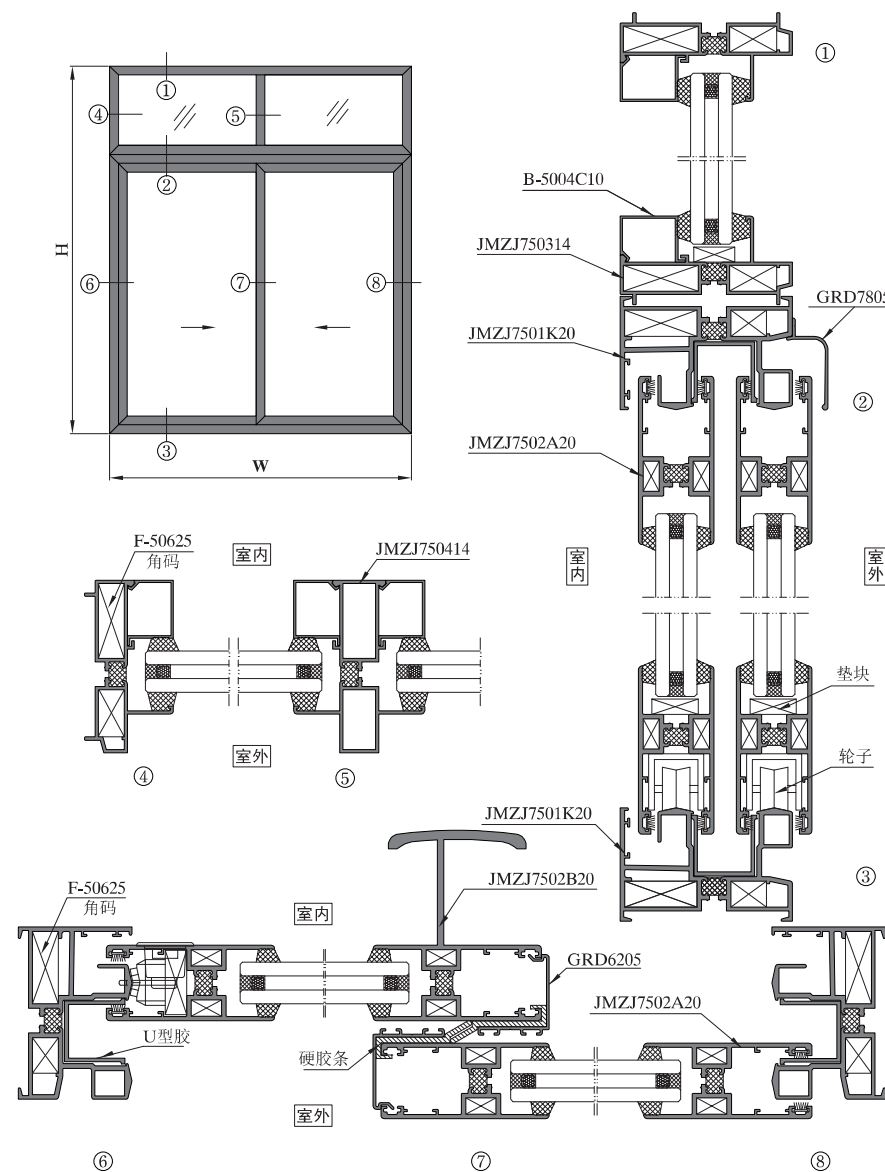

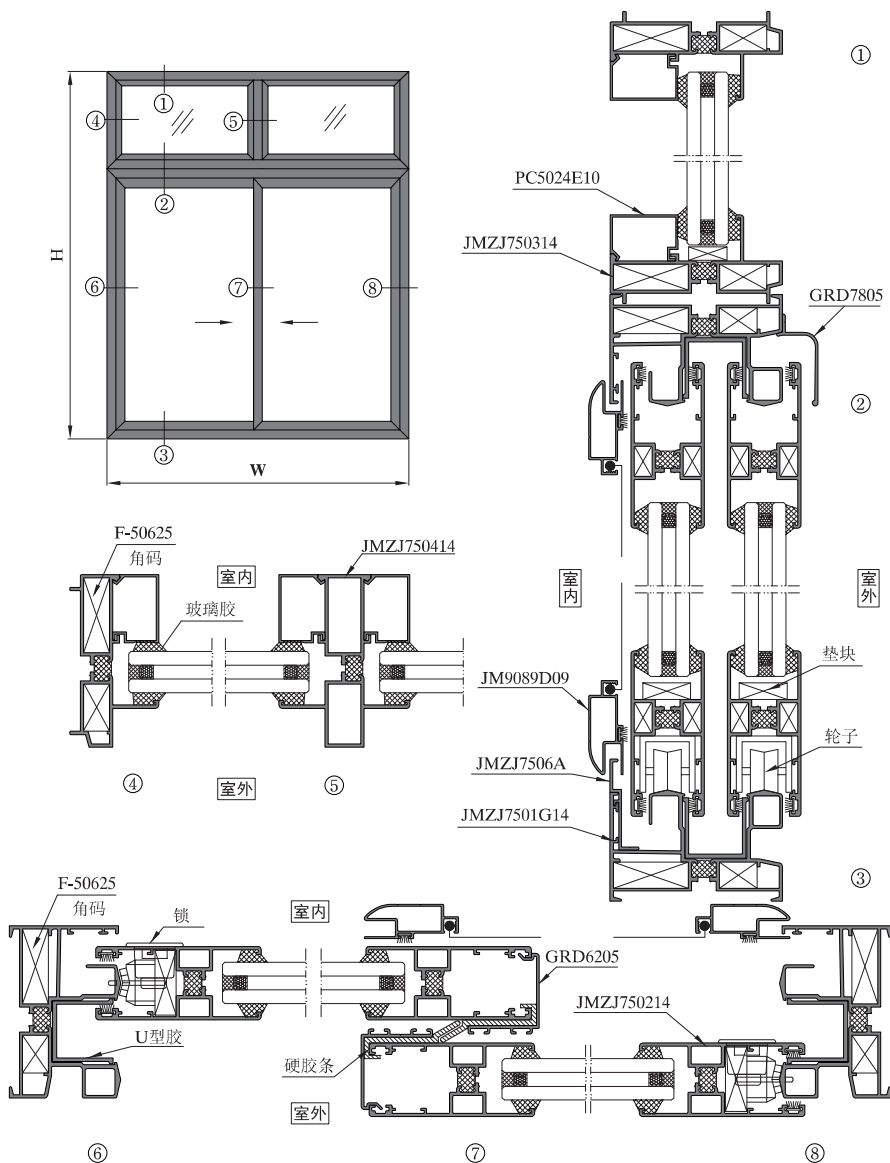

序号 S/N	型号理论重量 JMA Code & KG/M	型材图 Drawing	序号 S/N	型号理论重量 JMA Code & KG/M	型材图 Drawing	序号 S/N	型号理论重量 JMA Code & KG/M	型材图 Drawing
1	框料 JMZJ7501G14 1.638kg/m		10	中柱 JMZJ750414 1.210kg/m		19	JMZJ7506A 0.195kg/m	
2	框料 JMZJ7501K20 2.097kg/m		11	收口 JMZJ750712 0.431kg/m		20	扣条 GRD6205 0.292kg/m	
3	扇料 JMZJ750214 1.173kg/m		12	压线 B-5004C10 0.206kg/m		21	纱窗 JM9089D09 0.334kg/m	
4	扇料 JMZJ750220 1.491kg/m		13	压线 PC5024D10 0.194kg/m		22		
5	扇料 JMZJ7502A14 1.149kg/m		14	压线 PC5024E10 0.216kg/m		23		
6	扇料 JMZJ7502A20 1.466kg/m		15	压线 PC5024G10 0.177kg/m		24		
7	扇料 JMZJ7502B20 2.605kg/m		16	GRD7805 0.197kg/m		25		
8	扇料 JMZJ7502C20 2.164kg/m		17	角码 F-50625 1.786kg/m		26		
9	固定框 JMZJ750314 1.067kg/m		18	转角 JMGR5086K JMGR5086P 1.915kg/m		27		

注胶槽采用“AA”槽

图中所示型材截面、装配、编号、尺寸及重量仅供参考。如有疑问，请向本公司查询。
Information above just for your reference. Please contact us if you have any questions, Thank you!

图中所示型材截面、装配、编号、尺寸及重量仅供参考。如有疑问，请向本公司查询。
Information above just for your reference. Please contact us if you have any questions, Thank you!

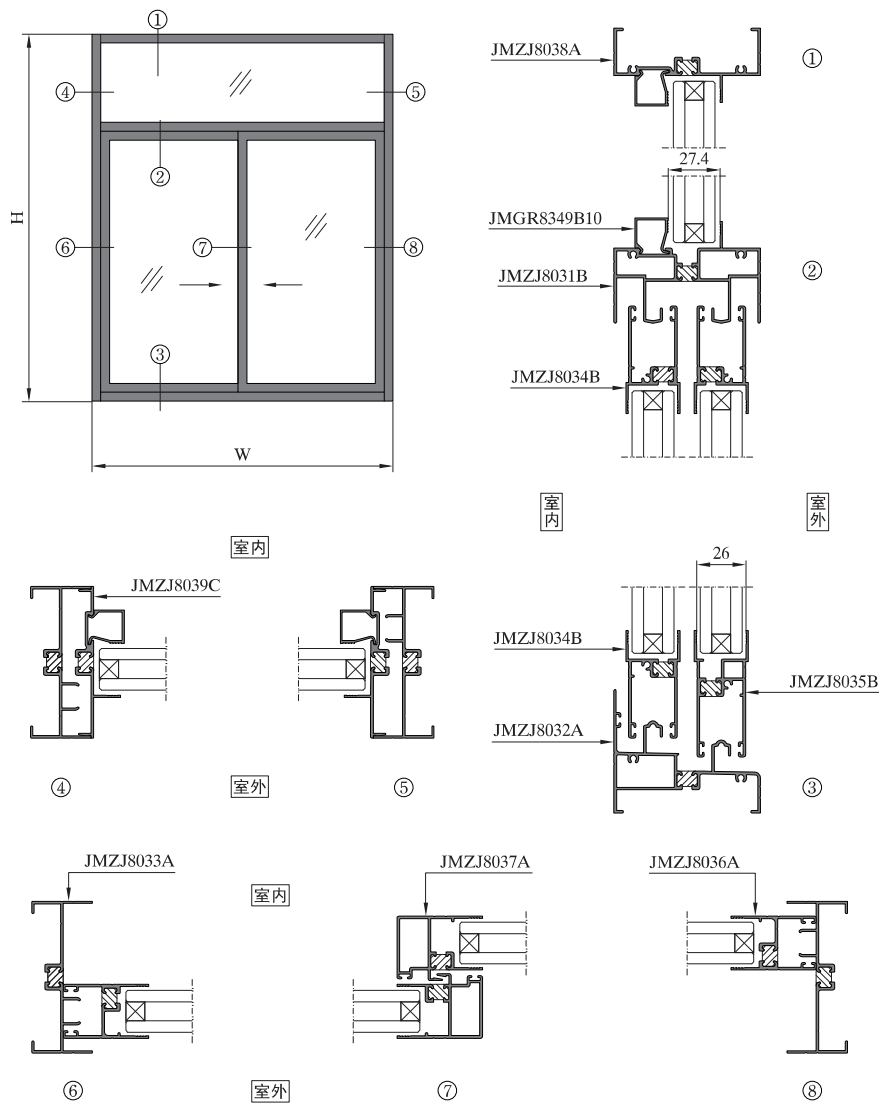

序号 S/N	型号理论重量 JMA Code & KG/M	型材图 Drawing	序号 S/N	型号理论重量 JMA Code & KG/M	型材图 Drawing	序号 S/N	型号理论重量 JMA Code & KG/M	型材图 Drawing
1	上滑 JMZJ8031A 1.209kg/m		10	光企 JMZJ8036A 0.684kg/m		19	压线 JMGR8349B10 0.178kg/m	
2	固上滑 JMZJ8031B 1.538kg/m		11	光企 JMZJ8036C 0.767kg/m		20	拼料 JMZJ8009C 0.705kg/m	
3	下滑 JMZJ8032C 1.285kg/m		12	勾企 JMZJ8037A 0.82kg/m		21		
4	下滑 JMZJ8032A 1.347kg/m		13	勾企 JMZJ8037C 0.842kg/m		22		
5	固下滑 JMZJ8032D 1.567kg/m		14	固定框 JMZJ8038A 0.882kg/m		23		
6	固下滑 JMZJ8032B 1.636kg/m		15	中柱 JMZJ8039A 1.369kg/m		24		
7	边封 JMZJ8033A 0.868kg/m		16	边封插板 JMZJ8039C 0.672kg/m		25		
8	小下方 JMZJ8034B 0.796kg/m		17	反插板 JMZJ8038B 0.729kg/m		26		
9	大下方 JMZJ8035B 0.967kg/m		18	收口 JMZJ8038C 0.396kg/m		27		

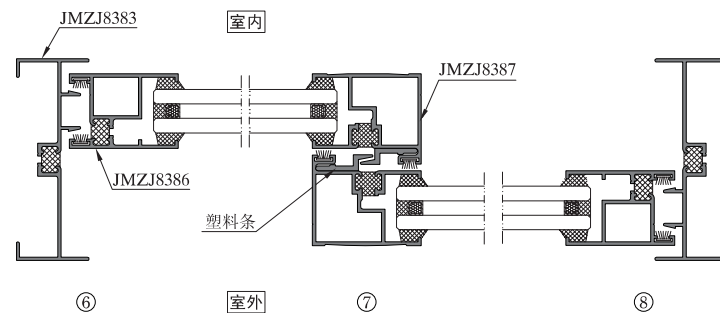
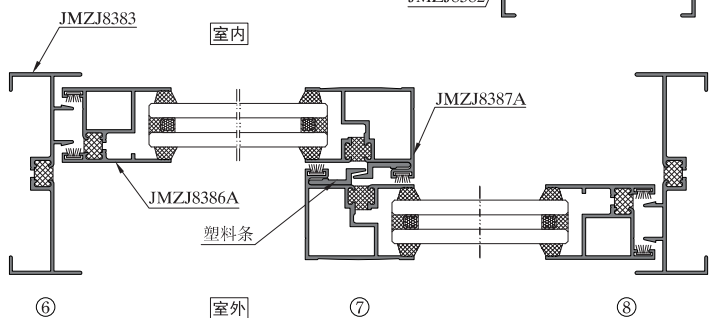
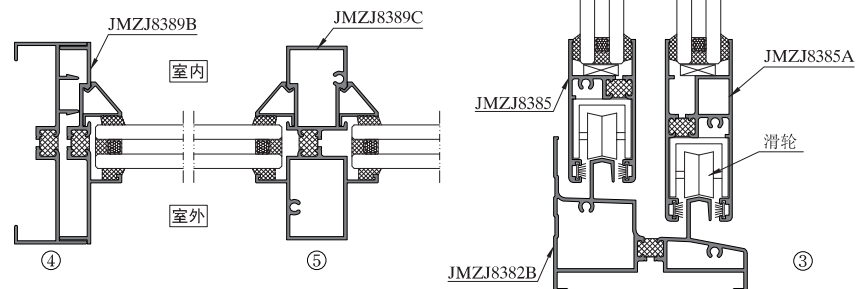
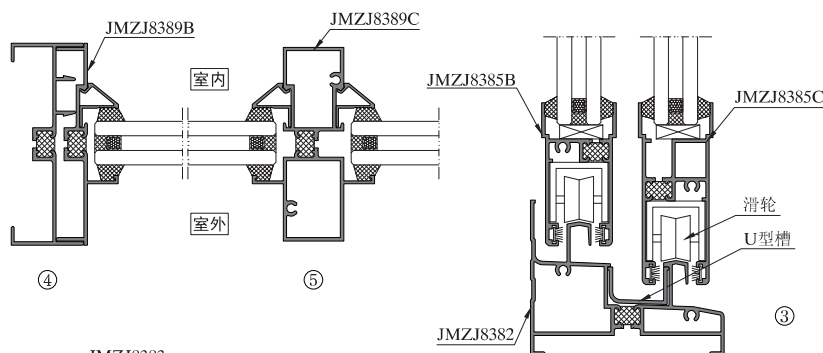
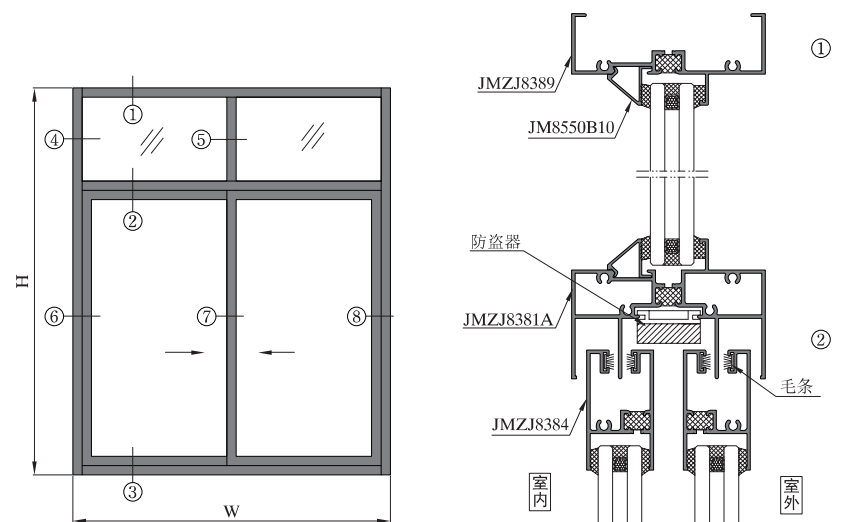
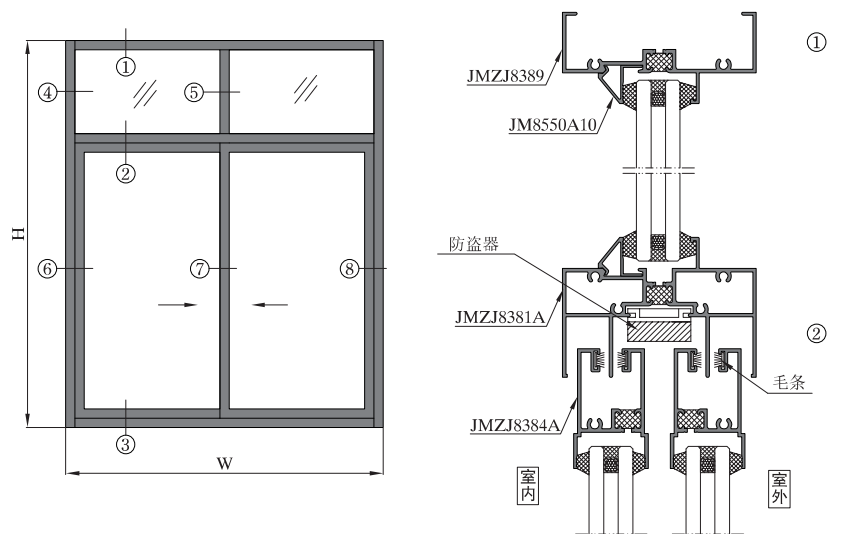

序号 S/N	型号理论重量 JMA Code & KG/M	型材图 Drawing	序号 S/N	型号理论重量 JMA Code & KG/M	型材图 Drawing	序号 S/N	型号理论重量 JMA Code & KG/M	型材图 Drawing
1	上滑 JMZJ8381 1.188kg/m		10	下方 JMZJ8385 0.893kg/m		19	上固 JMZJ8389 0.912kg/m	
2	带固上滑 JMZJ8381A 1.652kg/m		11	下方 JMZJ8385A 1.151kg/m		20	JMZJ8389A 0.667kg/m	
3	下滑 JMZJ8382 1.599kg/m		12	下方 JMZJ8385B 0.900kg/m		21	边封插板 JMZJ8389B 0.729kg/m	
4	带固下滑 JMZJ8382A 1.780kg/m		13	下方 JMZJ8385C 1.158kg/m		22	中柱 JMZJ8389C 1.347kg/m	
5	下滑 JMZJ8382B 1.596kg/m		14	光企 JMZJ8386 0.832kg/m		23	JMZJ8389D 1.095kg/m	
6	带固下滑 JMZJ8382C 1.777kg/m		15	光企 JMZJ8386A 0.812kg/m		24	JMZJ8389E 0.618kg/m	
7	边封 JMZJ8383 0.899kg/m		16	勾企 JMZJ8387 0.914kg/m		25	压线 JM8550A10 0.130kg/m	
8	上方 JMZJ8384 0.873kg/m		17	勾企 JMZJ8387A 0.895kg/m		26	压线 JM8550B10 0.126kg/m	
9	上方 JMZJ8384A 0.879kg/m		18	收口 JMZJ8388 0.416kg/m		27		

注胶槽采用“AA”槽

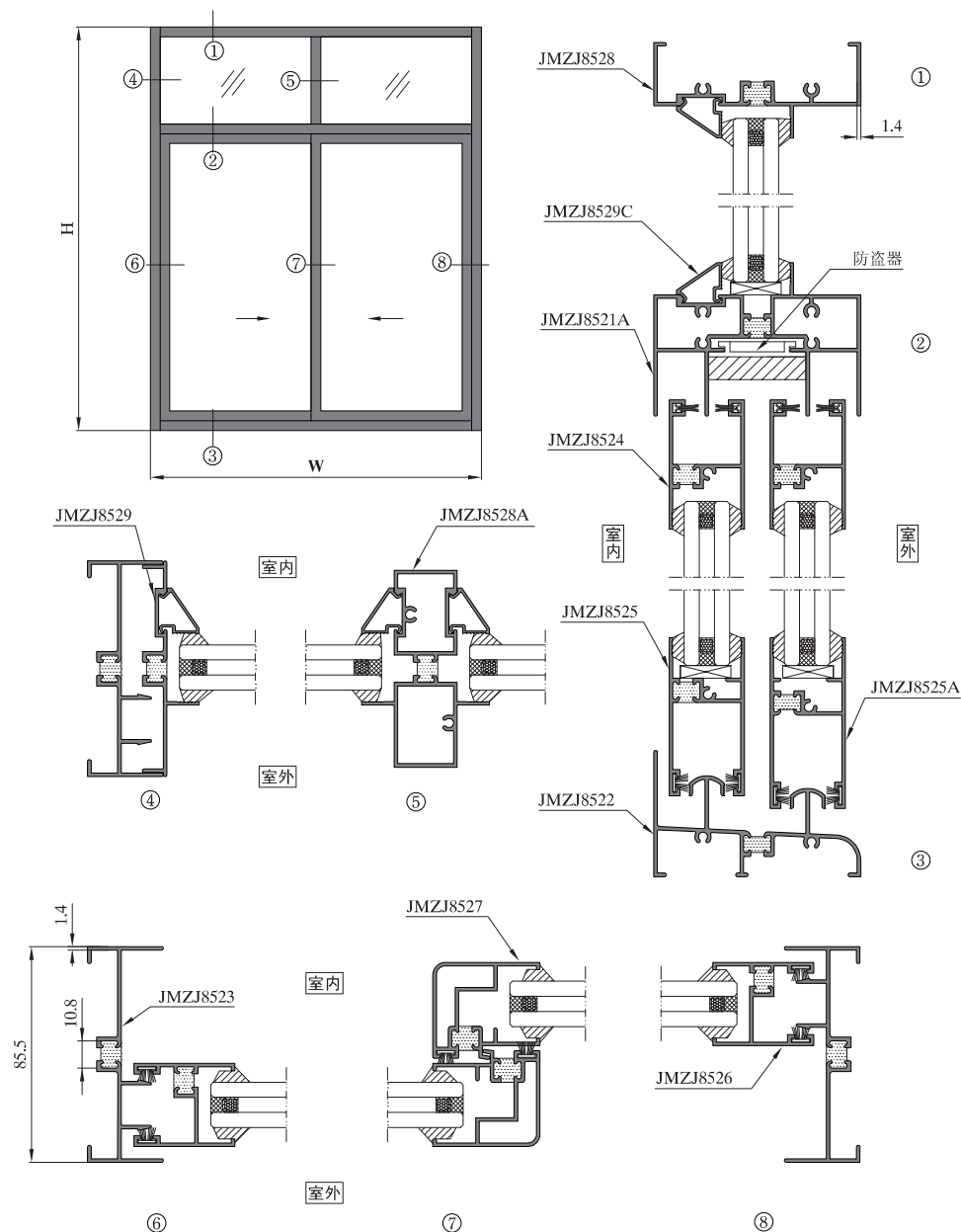

图中所示型材截面、装配、编号、尺寸及重量仅供参考。如有疑问，请向本公司查询。
Information above just for your reference. Please contact us if you have any questions, Thank you!

图中所示型材截面、装配、编号、尺寸及重量仅供参考。如有疑问，请向本公司查询。
Information above just for your reference. Please contact us if you have any questions, Thank you!

序号 S/N	型号理论重量 JMA Code & KG/M	型材图 Drawing	序号 S/N	型号理论重量 JMA Code & KG/M	型材图 Drawing	序号 S/N	型号理论重量 JMA Code & KG/M	型材图 Drawing
1	上滑 JMZJ8521 1.234kg/m		10	勾企 JMZJ8527 0.946kg/m		19		
2	带固上滑 JMZJ8521A 1.786kg/m		11	上固 JMZJ8528 0.959kg/m		20		
3	下滑 JMZJ8522 1.280kg/m		12	中柱 JMZJ8528A 1.359kg/m		21		
4	带固下滑 JMZJ8522A 1.749kg/m		13	边封插板 JMZJ8529 0.716kg/m		22		
5	边封 JMZJ8523 0.940kg/m		14	反插板 JMZJ8529A 0.762kg/m		23		
6	上方 JMZJ8524 0.816kg/m		15	收口 JMZJ8529B 0.475kg/m		24		
7	下方 JMZJ8525 0.913kg/m		16	压线 JMZJ8529C 0.133kg/m		25		
8	下方 JMZJ8525A 0.964kg/m		17			26		
9	光企 JMZJ8526 0.712kg/m		18			27		

注胶槽采用“AA”槽

图中所示型材截面、装配、编号、尺寸及重量仅供参考。如有疑问，请向本公司查询。
Information above just for your reference. Please contact us if you have any questions, Thank you!

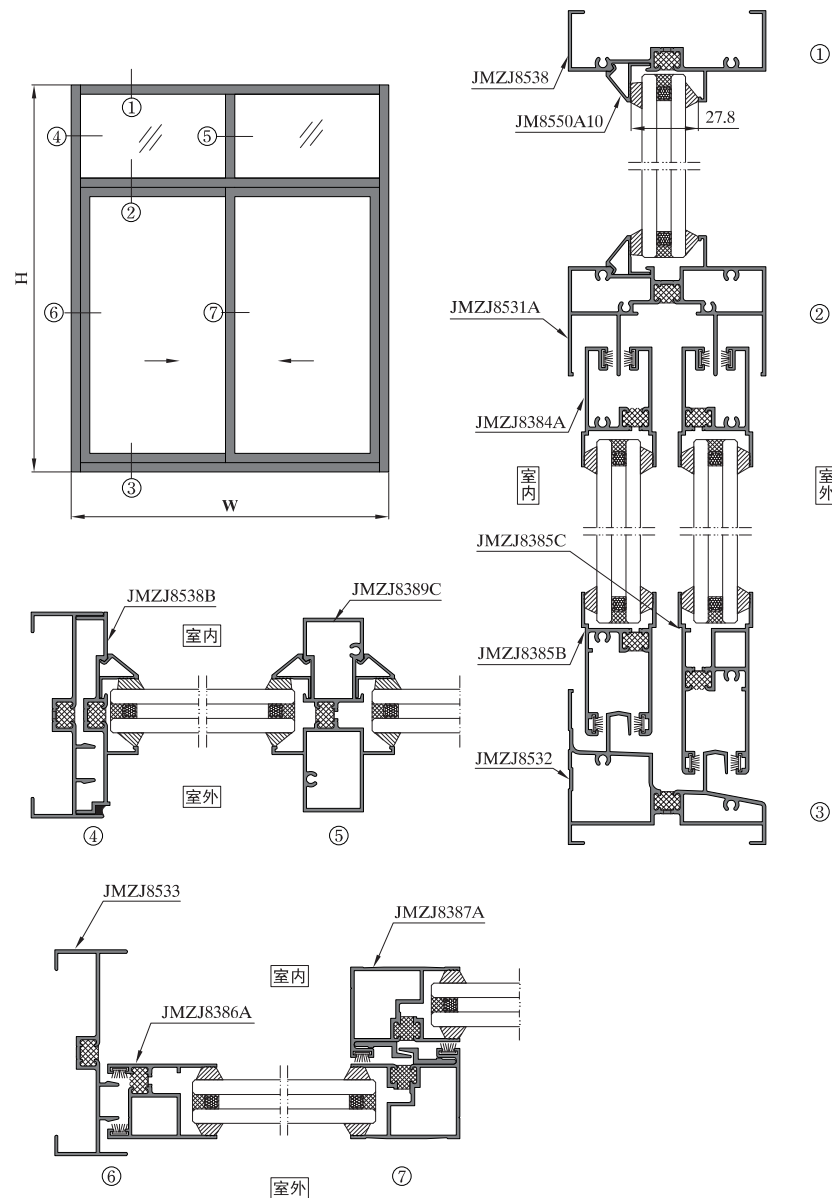

图中所示型材截面、装配、编号、尺寸及重量仅供参考。如有疑问，请向本公司查询。
Information above just for your reference. Please contact us if you have any questions, Thank you!

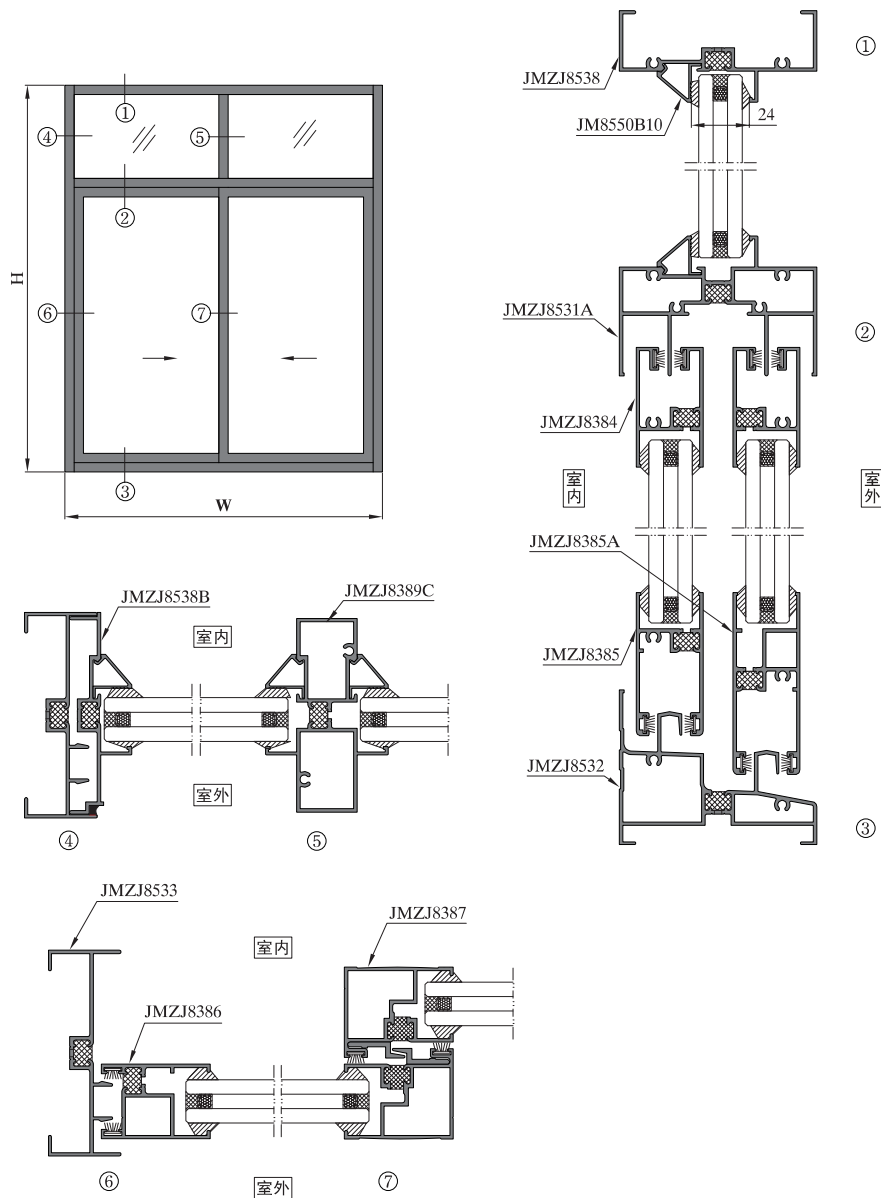

序号 S/N	型号理论重量 JMA Code & KG/M	型材图 Drawing	序号 S/N	型号理论重量 JMA Code & KG/M	型材图 Drawing	序号 S/N	型号理论重量 JMA Code & KG/M	型材图 Drawing
1	上滑 JMZJ8531 1.201kg/m		10	下方 JMZJ8385B 0.900kg/m		19	插板 JMZJ8538B 0.733kg/m	
2	带固上滑 JMZJ8531A 1.665kg/m		11	下方 JMZJ8385C 1.158kg/m		20	中柱 JMZJ8389C 1.347kg/m	
3	下滑 JMZJ8532 1.616kg/m		12	光企 JMZJ8386 0.832kg/m		21	拼料 JMZJ8389D 1.095kg/m	
4	带固下滑 JMZJ8532A 1.791kg/m		13	光企 JMZJ8386A 0.812kg/m		22	JMZJ8539 0.624kg/m	
5	边封 JMZJ8533 0.912kg/m		14	勾企 JMZJ8387 0.914kg/m		23	压线 JM8550A10 0.130kg/m	 压线开口27.8mm
6	上方 JMZJ8384 0.873kg/m		15	勾企 JMZJ8387A 0.895kg/m		24	压线 JM8550B10 0.126kg/m	 压线开口24mm
7	上方 JMZJ8384A 0.879kg/m		16	收口 JMZJ8388 0.416kg/m		25		
8	下方 JMZJ8385 0.893kg/m		17	上固 JMZJ8538 0.923kg/m		26		
9	下方 JMZJ8385A 1.151kg/m		18	插板 JMZJ8538A 0.674kg/m		27		

注胶槽采用“AA”槽

图中所示型材截面、装配、编号、尺寸及重量仅供参考。如有疑问，请向本公司查询。
Information above just for your reference. Please contact us if you have any questions, Thank you!

图中所示型材截面、装配、编号、尺寸及重量仅供参考。如有疑问，请向本公司查询。
Information above just for your reference. Please contact us if you have any questions, Thank you!

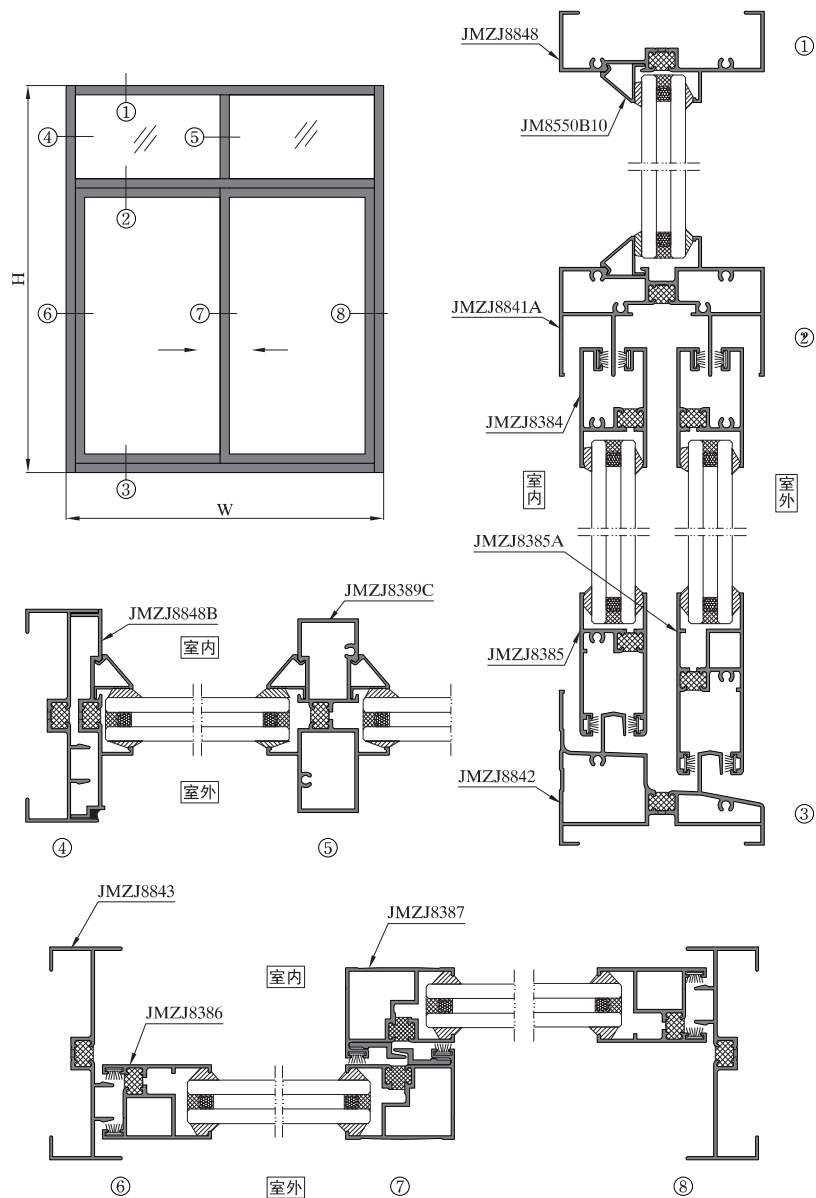

序号 S/N	型号理论重量 JMA Code & KG/M	型材图 Drawing	序号 S/N	型号理论重量 JMA Code & KG/M	型材图 Drawing	序号 S/N	型号理论重量 JMA Code & KG/M	型材图 Drawing
1	上滑 JMZJ8841 1.224kg/m		10	下方 JMZJ8385A 1.151kg/m		19	中柱 JMZJ8389C 1.347kg/m	
2	固上滑 JMZJ8841A 1.690kg/m		11	下方 JMZJ8385C 1.158kg/m		20	拼料 JMZJ8849 0.636kg/m	
3	下滑 JMZJ8842 1.650kg/m		12	光企 JMZJ8386 0.832kg/m		21	拼料 JMZJ8389D 1.095kg/m	
4	固下滑 JMZJ8842A 1.814kg/m		13	光企 JMZJ8386A 0.812kg/m		22	收口 JMZJ8388 0.416kg/m	
5	边封 JMZJ8843 0.934kg/m		14	勾企 JMZJ8387 0.914kg/m		23	压线 JMZJ8389L 0.164kg/m	 玻璃开口124.20mm 高度大于固定
6	上方 JMZJ8384 0.873kg/m		15	勾企 JMZJ8387A 0.895kg/m		24	压线 JMZJ8389K 0.162kg/m	 玻璃开口28.00mm 高度大于固定
7	上方 JMZJ8384A 0.879kg/m		16	固定框 JMZJ8848 0.946kg/m		25	压线 JM8550B10 0.126kg/m	 玻璃开口24.00mm
8	下方 JMZJ8385 0.893kg/m		17	插板 JMZJ8848A 0.686kg/m		26	压线 JM8550A10 0.130kg/m	 玻璃开口27.80mm
9	下方 JMZJ8385B 0.900kg/m		18	边封插板 JMZJ8848B 0.745kg/m		27		

注胶槽采用“AA”槽

图中所示型材截面、装配、编号、尺寸及重量仅供参考。如有疑问，请向本公司查询。
Information above just for your reference. Please contact us if you have any questions, Thank you!

图中所示型材截面、装配、编号、尺寸及重量仅供参考。如有疑问，请向本公司查询。
Information above just for your reference. Please contact us if you have any questions, Thank you!

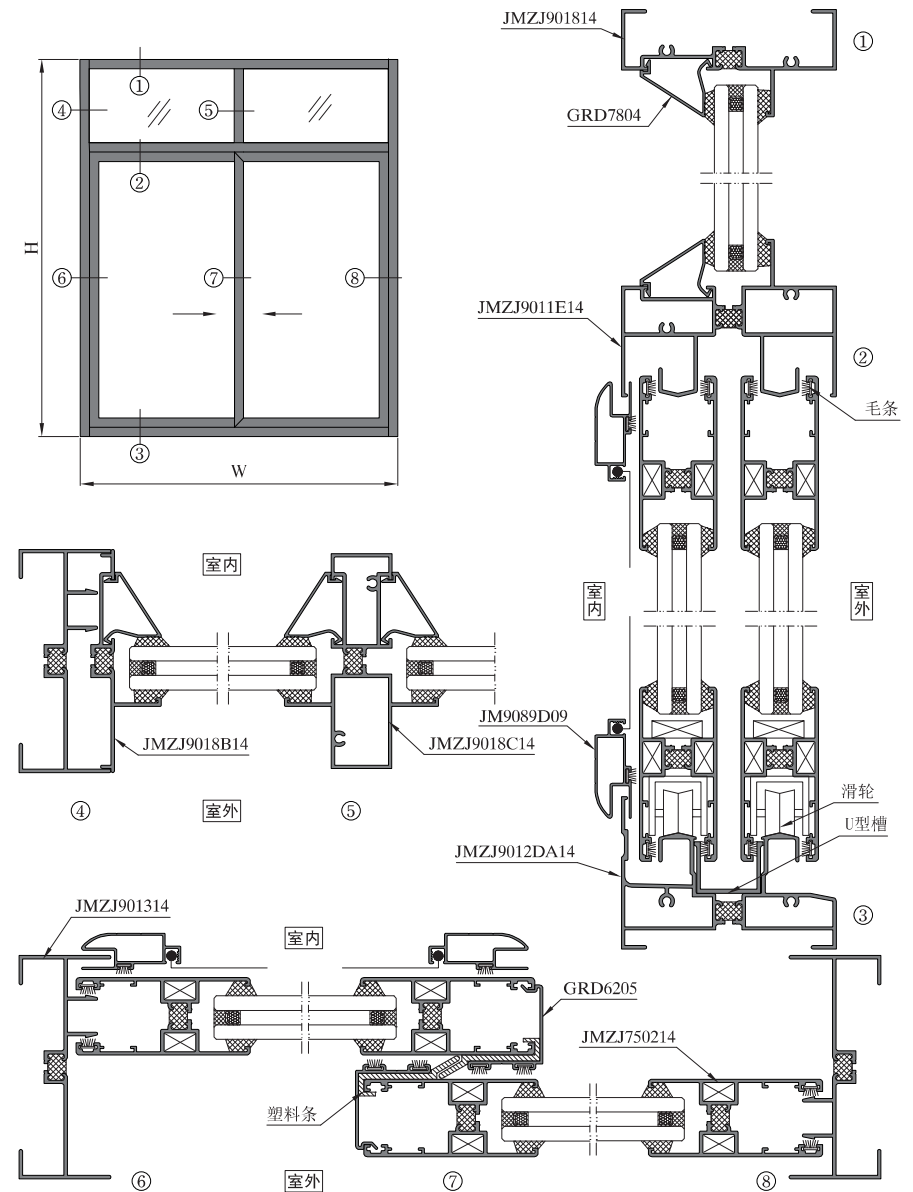
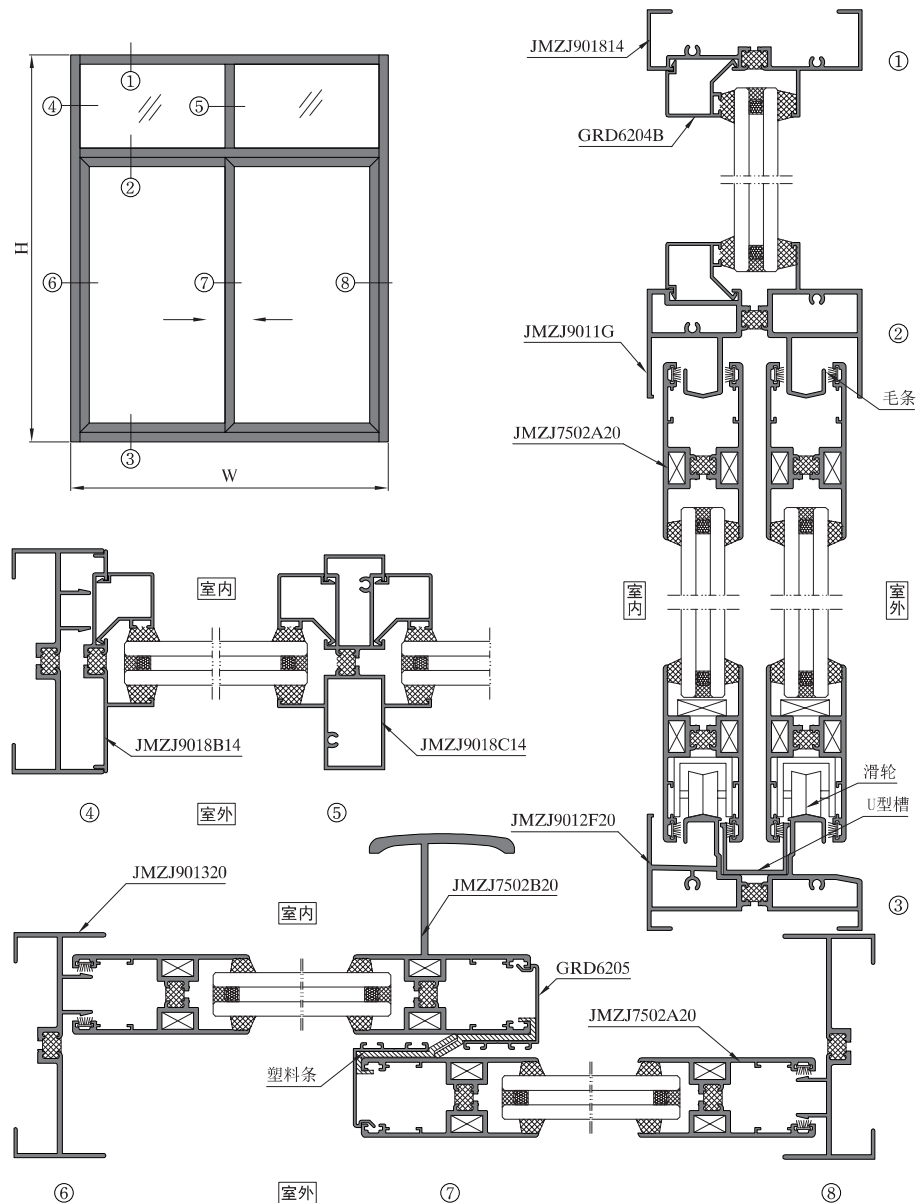

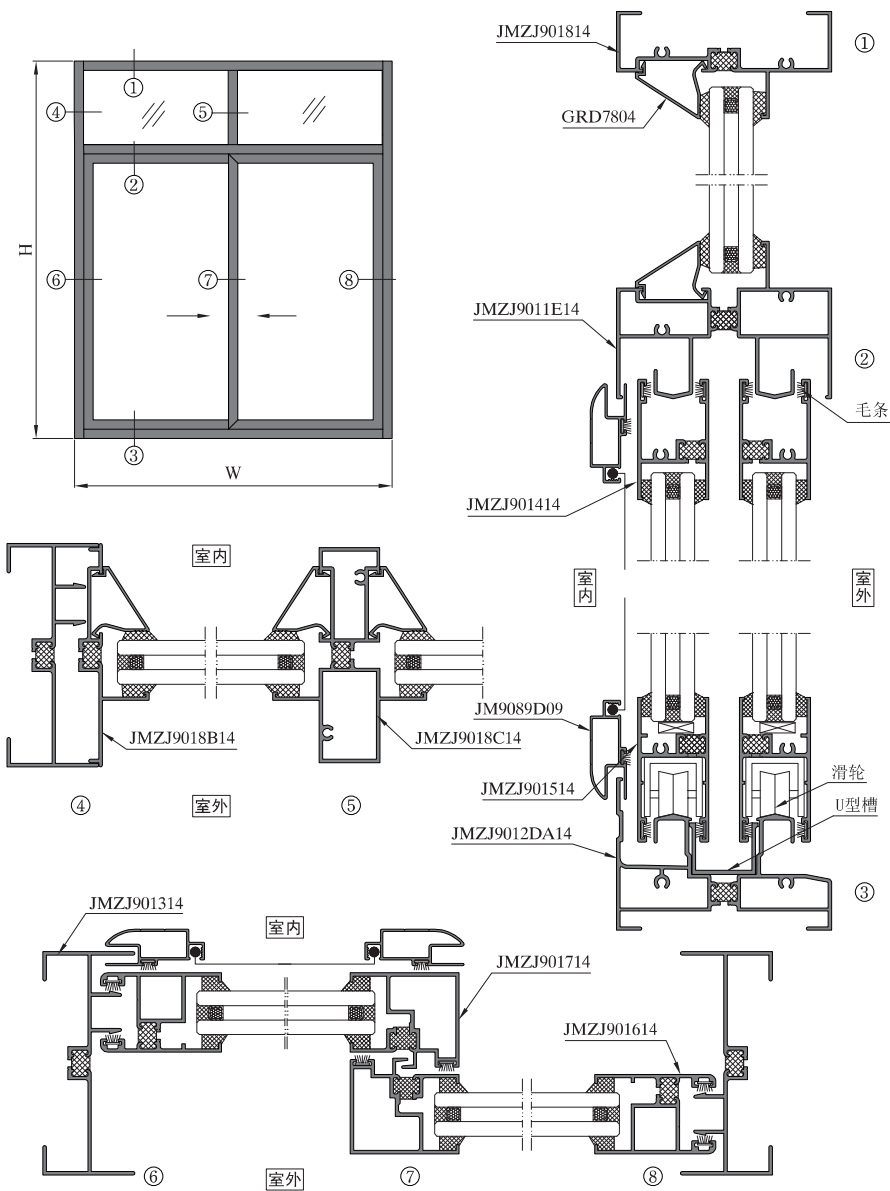

序号 S/N	型号理论重量 JMA Code & KG/M	型材图 Drawing	序号 S/N	型号理论重量 JMA Code & KG/M	型材图 Drawing	序号 S/N	型号理论重量 JMA Code & KG/M	型材图 Drawing
1	上滑 JMZJ9011D14 1.498kg/m		10	上方 JMZJ901414 0.786kg/m		19	扇料 JMZJ750220 1.491kg/m	
2	带固上滑 JMZJ9011E14 1.915kg/m		11	上方 JMZJ9014A14 0.792kg/m		20	扇料 JMZJ7502A14 1.149kg/m	
3	上滑 JMZJ9011F 1.834kg/m		12	下方 JMZJ901514 0.887kg/m		21	扇料 JMZJ7502A20 1.466kg/m	
4	带固上滑 JMZJ9011G 2.426kg/m		13	下方 JMZJ9015A14 0.892kg/m		22	扇料 JMZJ7502B20 2.605kg/m	
5	下滑 JMZJ9012DA14 1.840kg/m		14	光企 JMZJ901614 0.943kg/m		23	扇料 JMZJ7502C20 2.164kg/m	
6	带固下滑 JMZJ9012EA14 1.994kg/m		15	光企 JMZJ9016A14 0.921kg/m		24	单勾 GRD6205 0.292kg/m	
7	下滑 JMZJ9012F20 2.163kg/m		16	勾企 JMZJ901714 0.964kg/m		25	收口 JMZJ750712 0.431kg/m	
8	边封 JMZJ901314 1.085kg/m		17	勾企 JMZJ9017A14 0.943kg/m		26	上固 JMZJ901814 1.041kg/m	
9	边封 JMZJ901320 1.351kg/m		18	扇料 JMZJ750214 1.173kg/m		27	中柱 JMZJ9018C14 1.506kg/m	

注胶槽采用“AA”槽

图中所示型材截面、装配、编号、尺寸及重量仅供参考。如有疑问，请向本公司查询。
Information above just for your reference. Please contact us if you have any questions, Thank you!

图中所示型材截面、装配、编号、尺寸及重量仅供参考。如有疑问，请向本公司查询。
Information above just for your reference. Please contact us if you have any questions, Thank you!

序号 S/N	型号理论重量 JMA Code & KG/M	型材图 Drawing	序号 S/N	型号理论重量 JMA Code & KG/M	型材图 Drawing	序号 S/N	型号理论重量 JMA Code & KG/M	型材图 Drawing
28	边封插板 JMZJ9018B14 0.746kg/m		37			46		
29	拼料 JMZJ901914 0.755kg/m		38			47		
30	纱窗 JM9089D09 0.334kg/m		39			48		
31	框压线 GRD7804 0.200kg/m		40			49		
32	框压线 GRD7804A 0.190kg/m		41			50		
33	框压线 GRD6204 0.296kg/m		42			51		
34	框压线 GRD6204A 0.240kg/m		43			52		
35	框压线 GRD6204B 0.288kg/m		44			53		
36			45			54		

注胶槽采用“AA”槽

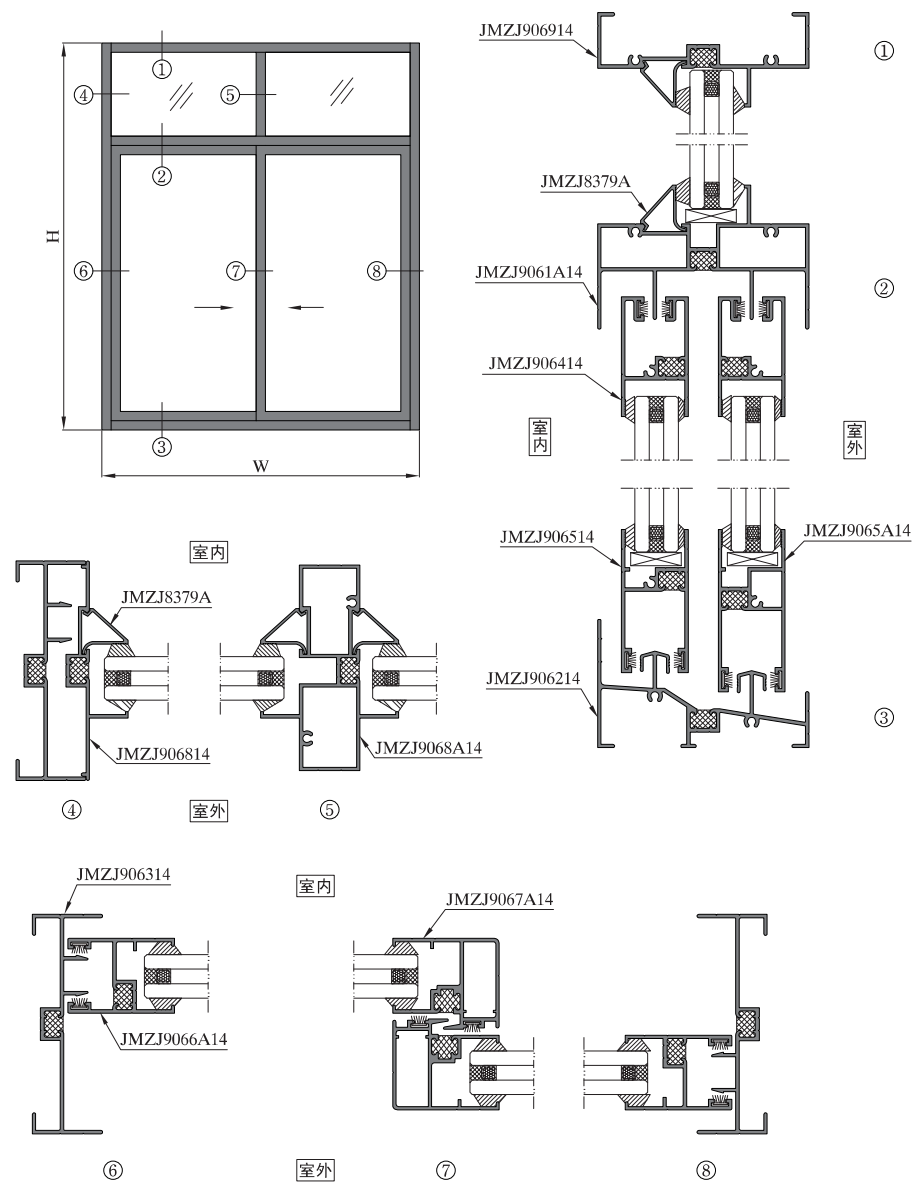

图中所示型材截面、装配、编号、尺寸及重量仅供参考。如有疑问，请向本公司查询。
Information above just for your reference. Please contact us if you have any questions, Thank you!

图中所示型材截面、装配、编号、尺寸及重量仅供参考。如有疑问，请向本公司查询。
Information above just for your reference. Please contact us if you have any questions, Thank you!

序号 S/N	型号理论重量 JMA Code & KG/M	型材图 Drawing	序号 S/N	型号理论重量 JMA Code & KG/M	型材图 Drawing	序号 S/N	型号理论重量 JMA Code & KG/M	型材图 Drawing
1	上滑 JMZJ906114 1.140kg/m		10	下方 JMZJ9065A14 1.017kg/m		19	下滑反盖板 JMZJ9068B14 0.824kg/m	
2	带固上滑 JMZJ9061A14 1.602kg/m		11	下方 JMZJ9065B14 0.870kg/m		20	上固 JMZJ906914 0.946kg/m	
3	下滑 JMZJ906214 1.349kg/m		12	下方 JMZJ9065C14 1.018kg/m		21	90° 转角 JMZJ9069A15 2.375kg/m	
4	带固下滑 JMZJ9062A14 1.700kg/m		13	光企 JMZJ906614 0.735kg/m		22	框压线 JMZJ8379A 0.138kg/m	
5	边封 JMZJ906314 0.947kg/m		14	光企 JMZJ9066A14 0.754kg/m		23		
6	边封 JMZJ9063A14 0.980kg/m		15	勾企 JMZJ906714 0.914kg/m		24		
7	上方 JMZJ906414 0.896kg/m		16	勾企 JMZJ9067A14 0.932kg/m		25		
8	上方 JMZJ9064A14 0.899kg/m		17	边封插板 JMZJ906814 0.694kg/m		26		
9	下方 JMZJ906514 0.869kg/m		18	中柱 JMZJ9068A14 1.412kg/m		27		

注胶槽采用“AA”槽

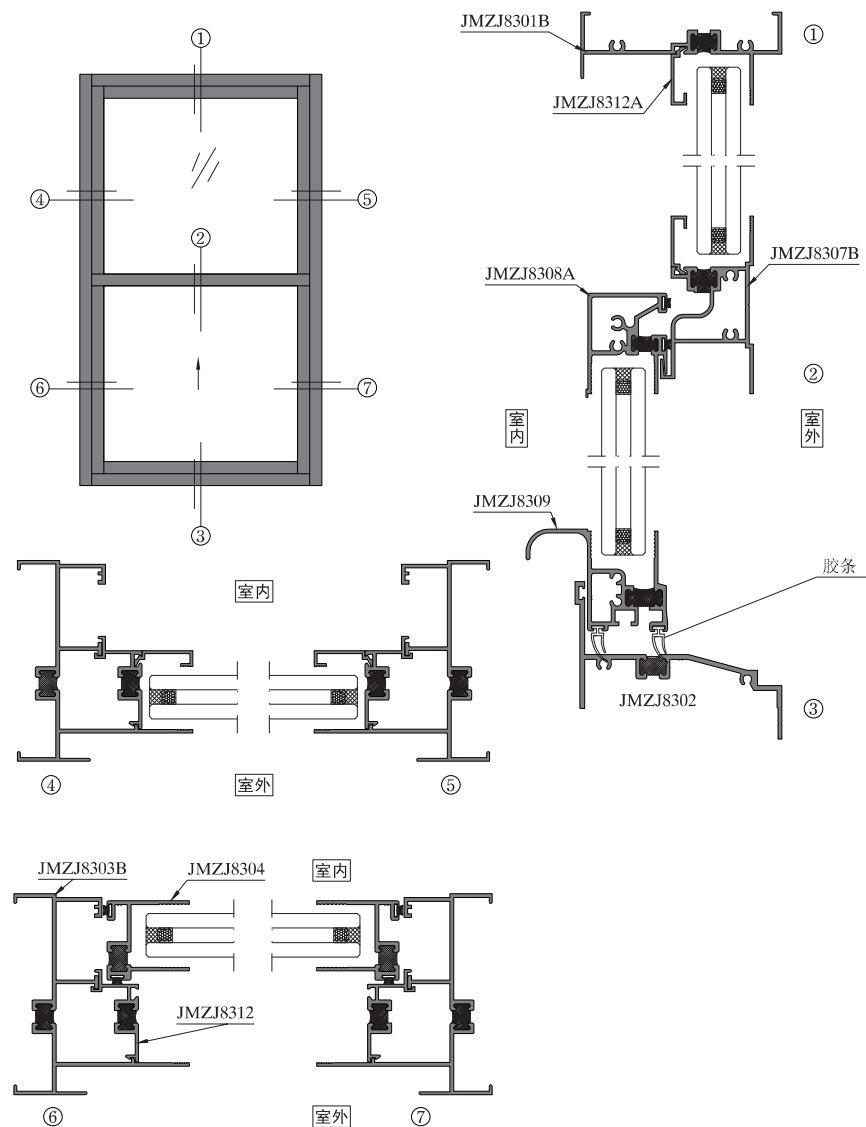

图中所示型材截面、装配、编号、尺寸及重量仅供参考。如有疑问，请向本公司查询。
Information above just for your reference. Please contact us if you have any questions, Thank you!

图中所示型材截面、装配、编号、尺寸及重量仅供参考。如有疑问，请向本公司查询。
Information above just for your reference. Please contact us if you have any questions, Thank you!

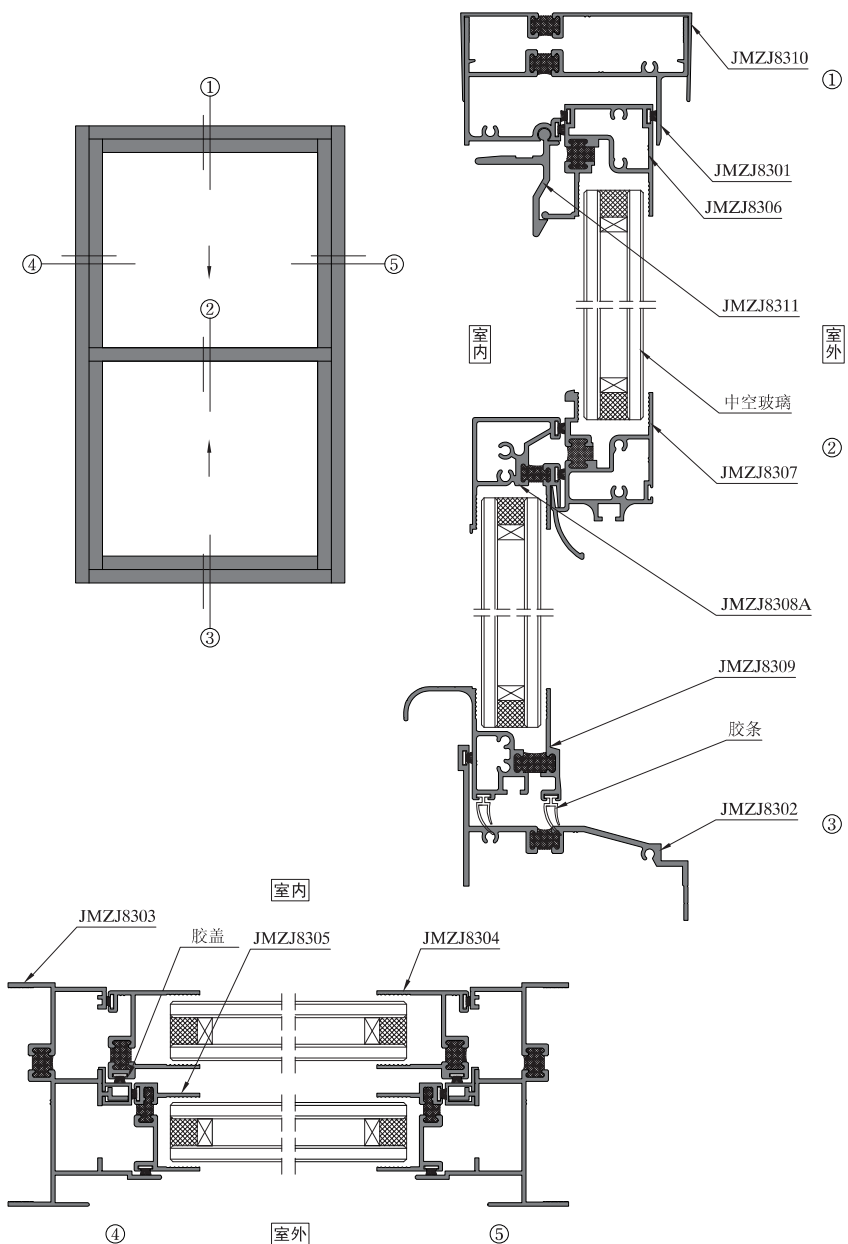

序号 S/N	型号理论重量 JMA Code & KG/M	型材图 Drawing	序号 S/N	型号理论重量 JMA Code & KG/M	型材图 Drawing	序号 S/N	型号理论重量 JMA Code & KG/M	型材图 Drawing
1	JMZJ8301 1.356kg/m		10	JMZJ8307B 1.191kg/m		19		
2	JMZJ8301B 0.969kg/m		11	JMZJ8308A 1.044kg/m		20		
3	JMZJ8302 1.215kg/m		12	JMZJ8309 1.117kg/m		21		
4	JMZJ8303 1.341kg/m		13	JMZJ8310 0.758kg/m		22		
5	JMZJ8303B 1.263kg/m		14	JMZJ8311 0.546kg/m		23		
6	JMZJ8304 0.678kg/m		15	JMZJ8312 0.485kg/m		24		
7	JMZJ8305 0.564kg/m		16	JMZJ8312A 0.130kg/m		25		
8	JMZJ8306 1.058kg/m		17			26		
9	JMZJ8307 1.233kg/m		18			27		

注胶槽采用“AA”槽

图中所示型材截面、装配、编号、尺寸及重量仅供参考。如有疑问，请向本公司查询。
Information above just for your reference. Please contact us if you have any questions, Thank you!

图中所示型材截面、装配、编号、尺寸及重量仅供参考。如有疑问，请向本公司查询。
Information above just for your reference. Please contact us if you have any questions, Thank you!

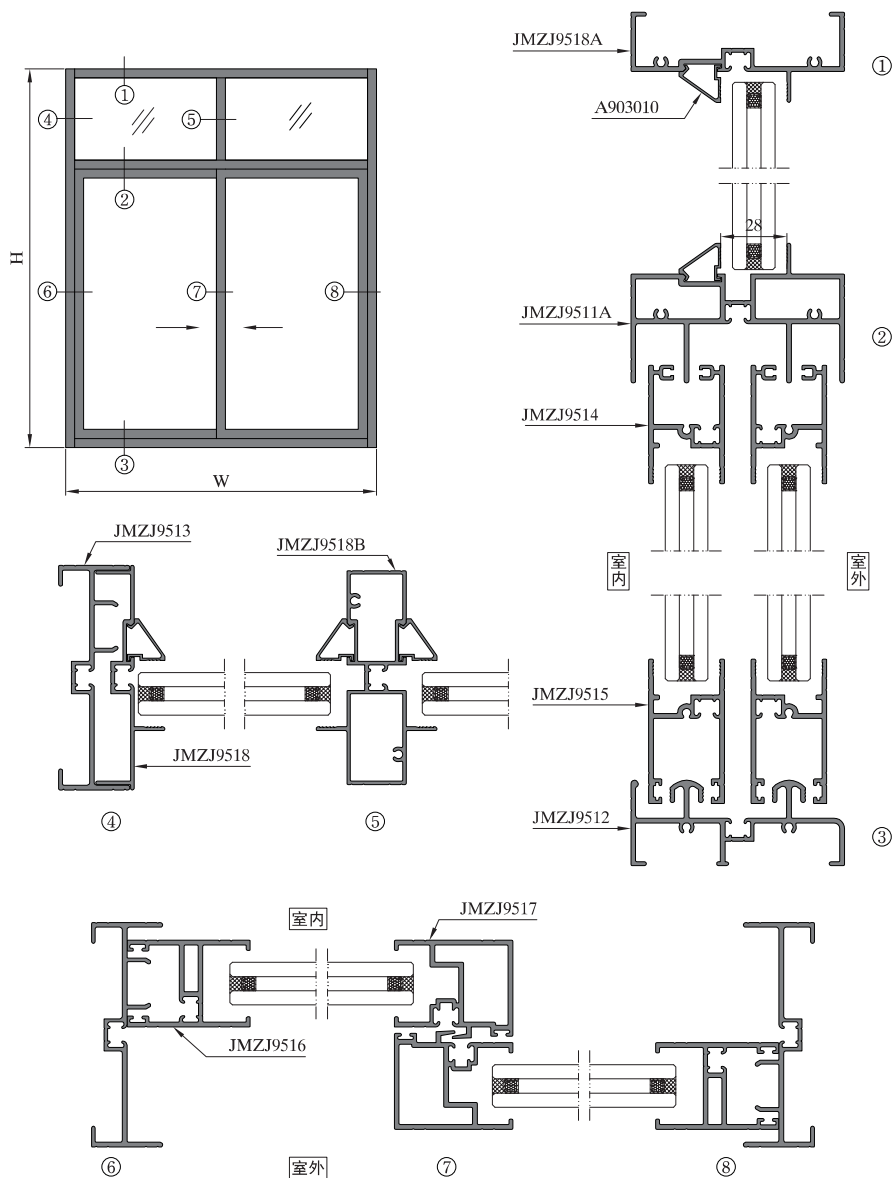

序号 S/N	型号理论重量 JMA Code & KG/M	型材图 Drawing	序号 S/N	型号理论重量 JMA Code & KG/M	型材图 Drawing	序号 S/N	型号理论重量 JMA Code & KG/M	型材图 Drawing
1	上滑 JMZJ9511 1.549kg/m		10	中挺 JMZJ9518B 1.436kg/m		19		
2	固定上滑 JMZJ9511A 2.249kg/m		11	边封插板 JMZJ9518 0.805kg/m		20		
3	下滑 JMZJ9512 1.674kg/m		12	压线 A903010 0.134kg/m		21		
4	边封 JMZJ9513 1.226kg/m		13			22		
5	上方 JMZJ9514 1.094kg/m		14			23		
6	下方 JMZJ9515 1.165kg/m		15			24		
7	光企 JMZJ9516 1.164kg/m		16			25		
8	勾企 JMZJ9517 1.332kg/m		17			26		
9	上固 JMZJ9518A 1.18kg/m		18			27		

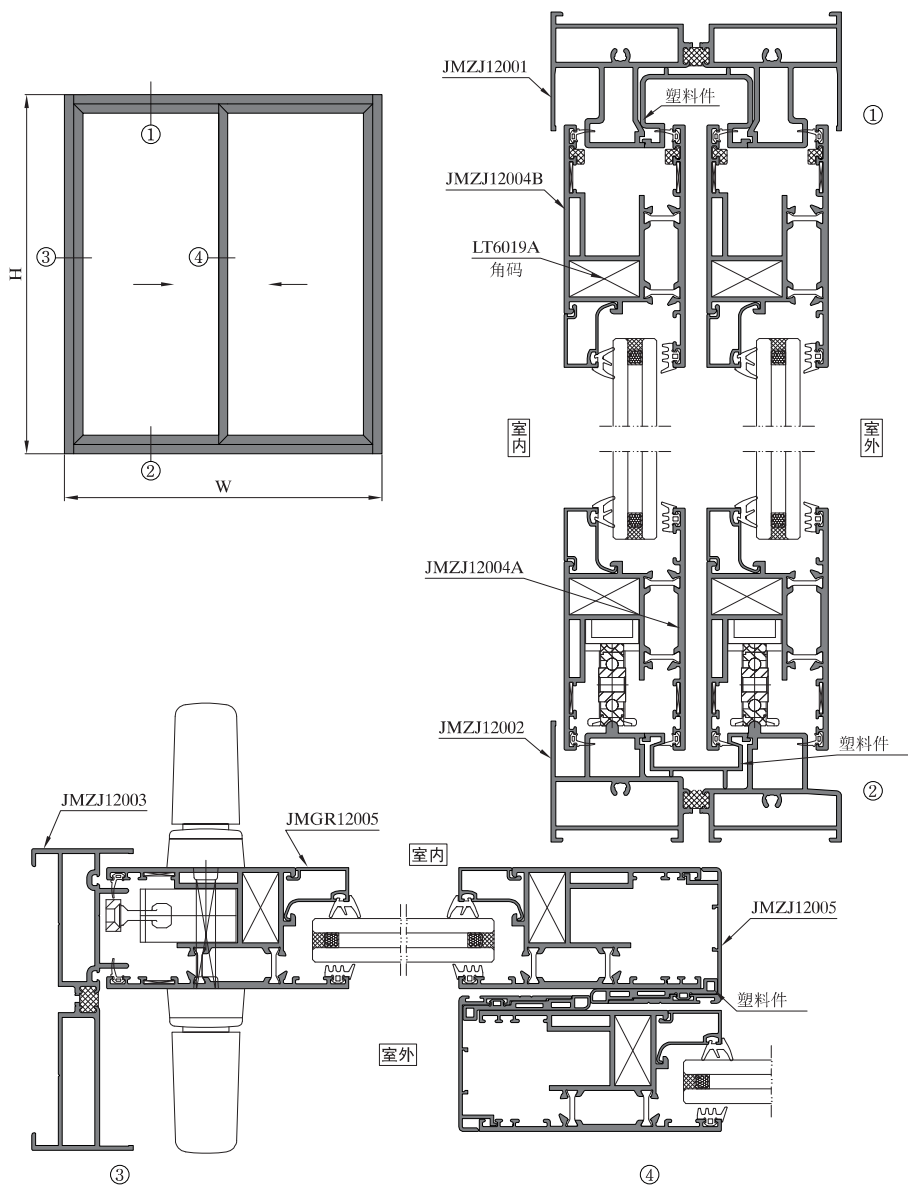

序号 S/N	型号理论重量 JMA Code & KG/M	型材图 Drawing	序号 S/N	型号理论重量 JMA Code & KG/M	型材图 Drawing	序号 S/N	型号理论重量 JMA Code & KG/M	型材图 Drawing
1	上滑 JMZJ12001 3.268kg/m		10			19		
2	下滑 JMZJ12002 3.012kg/m		11			20		
3	边封 JMZJ12003 2.228kg/m		12			21		
4	扇料 JMZJ12004A JMZJ12004B 2.391kg/m		13			22		
5	单勾 JMZJ12005 0.594kg/m		14			23		
6	扇压线 JMGR12005 0.262kg/m		15			24		
7	收口 JMZJ12006 0.740kg/m		16			25		
8	扇角码 LT6019A 2.507kg/m		17			26		
9			18			27		

注胶槽采用“AA”槽

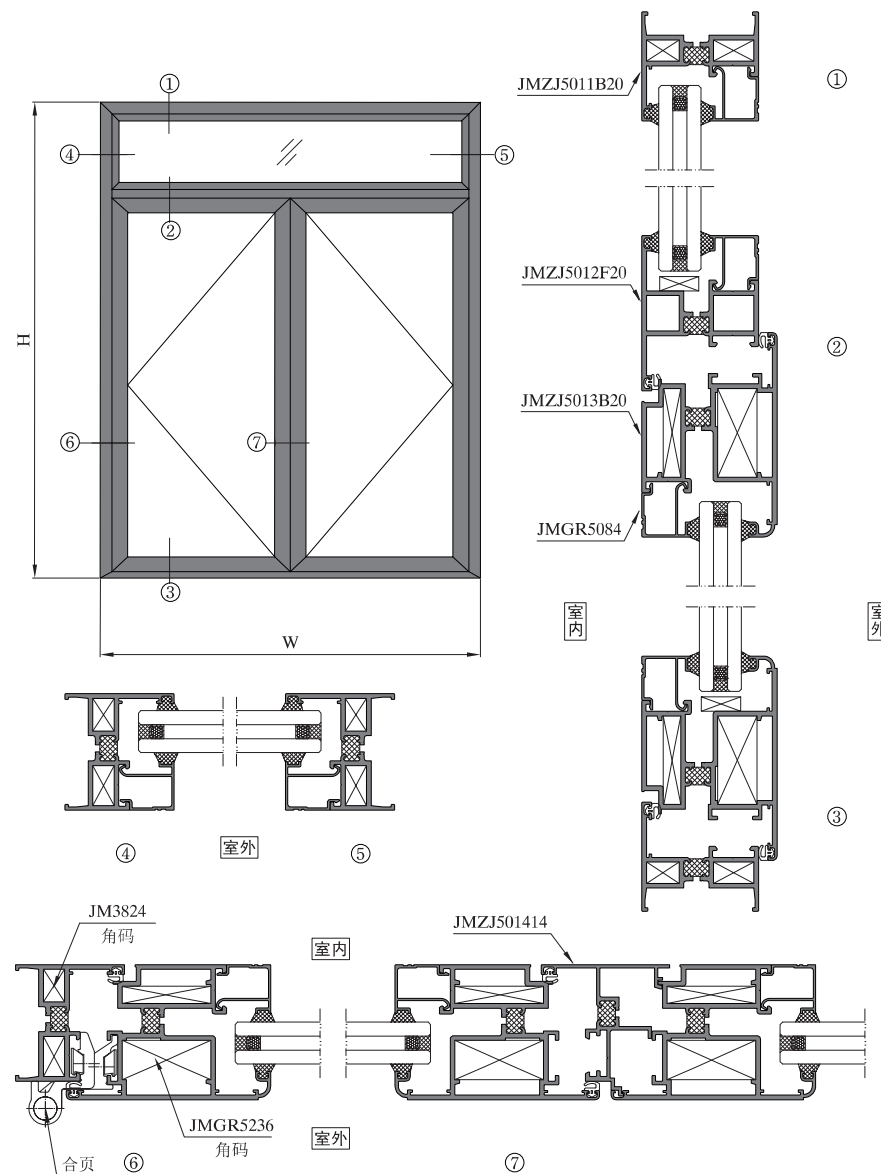
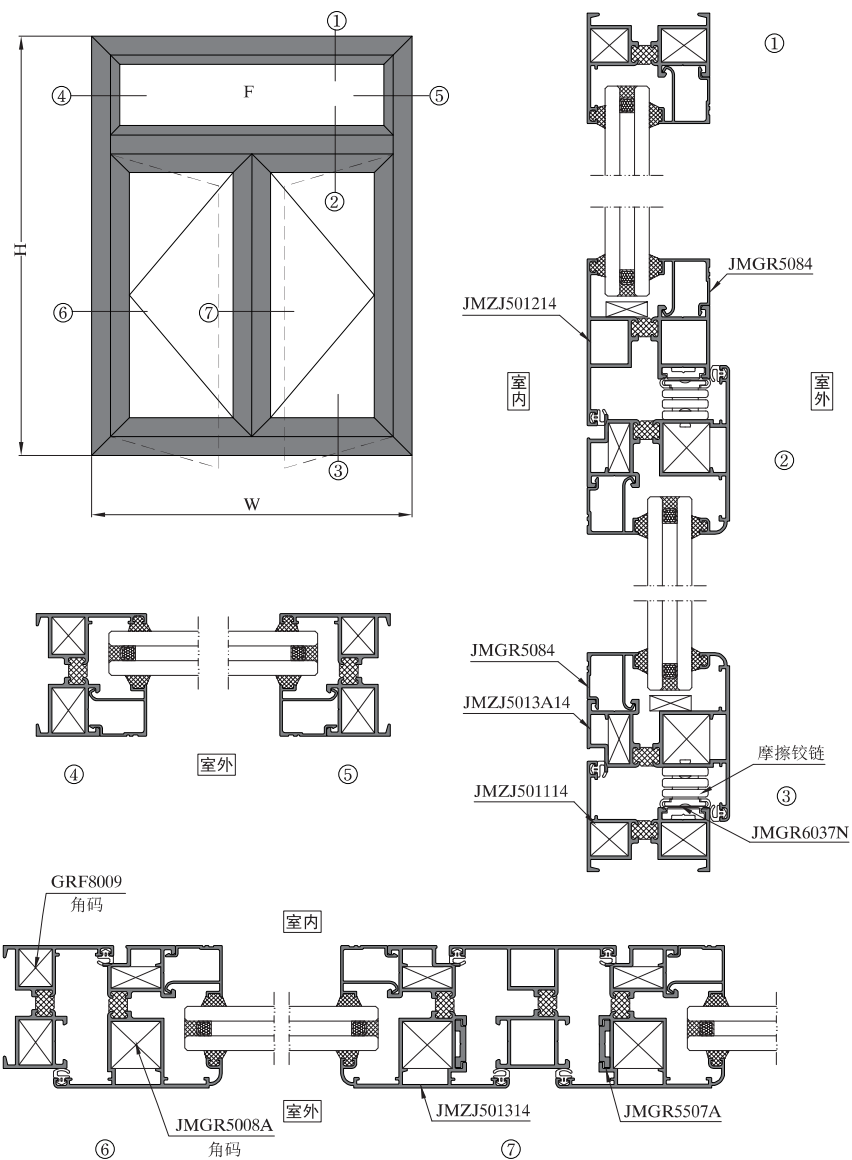

序号 S/N	型号理论重量 JMA Code & KG/M	型材图 Drawing	序号 S/N	型号理论重量 JMA Code & KG/M	型材图 Drawing	序号 S/N	型号理论重量 JMA Code & KG/M	型材图 Drawing
1	框料 JMZJ501114 0.988kg/m	角码配GRF8009 	10	扇料 JMZJ501314 1.350kg/m	角码配JMGR5008A 	19	框扇压线 JMGR5084G 0.205kg/m	玻璃开口25mm
2	框料 JMZJ5011A14 0.893kg/m	角码配JM3824 	11	扇料 JMZJ5013A14 1.288kg/m	角码配JMGR5008A 	20	拼料 JMZJ5016 0.109kg/m 配JMZJ5011A14	
3	框料 JMZJ5011B20 1.187kg/m	角码配JM3824 	12	扇料 JMZJ5013B20 2.166kg/m	角码配JMGR5236 	21	中挺连接件 JMGR6037A 0.522kg/m	
4	中挺 JMZJ501214 1.157kg/m		13	假中挺 JMZJ501414 0.950kg/m		22	中挺连接件 JMGR5707 0.592kg/m	
5	中挺 JMZJ5012A14 1.164kg/m		14	转换料 JMZJ5015A14 0.672kg/m		23	中挺连接件 JMGR6037G 0.796kg/m	
6	加强中挺 JMZJ5012B14 1.591kg/m		15	转角 JMGR5086K JMGR5086M 1.507kg/m	角码配JMGR5086K 配JMZJ501114 	24	传动杆 JMGR5507A 0.153kg/m	
7	中挺 JMZJ5012C14 1.109kg/m		16	框扇压线 JMGR5084 0.230kg/m	玻璃开口24.8mm 	25	传动杆 JMGR6037N 0.161kg/m	
8	中挺 JMZJ5012E14 1.191kg/m		17	框扇压线 JMGR5084A 0.203kg/m	玻璃开口29mm 	26	中挺连接件 JMGR5267D 1.745kg/m	
9	中挺 JMZJ5012F20 1.427kg/m		18	框扇压线 JMGR5084F 0.178kg/m	玻璃开口29mm 	27	框角码 JM3824 1.331kg/m	

注胶槽采用“AA”槽

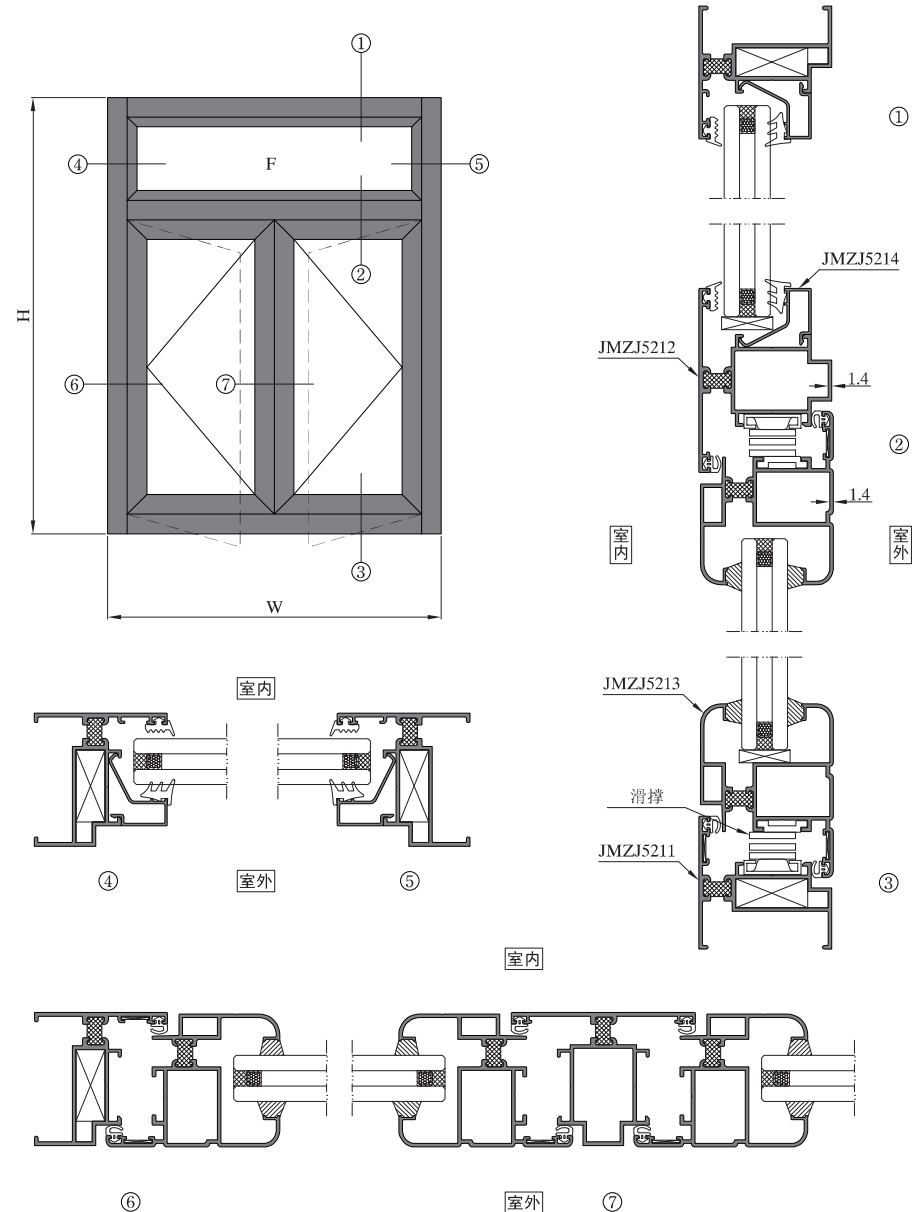

图中所示型材截面、装配、编号、尺寸及重量仅供参考。如有疑问，请向本公司查询。
Information above just for your reference. Please contact us if you have any questions, Thank you!

图中所示型材截面、装配、编号、尺寸及重量仅供参考。如有疑问，请向本公司查询。
Information above just for your reference. Please contact us if you have any questions, Thank you!

序号 S/N	型号理论重量 JMA Code & KG/M	型材图 Drawing	序号 S/N	型号理论重量 JMA Code & KG/M	型材图 Drawing	序号 S/N	型号理论重量 JMA Code & KG/M	型材图 Drawing
1	框料 JMZJ5211 1.020kg/m		10			19		
2	中挺 JMZJ5212 1.178kg/m		11			20		
3	扇料 JMZJ5213 1.302kg/m		12			21		
4	框压线 JMZJ5214 0.208kg/m		13			22		
5	角码 F-50625 1.786kg/m		14			23		
6	角码 JMGR5008 2.351kg/m		15			24		
7			16			25		
8			17			26		
9			18			27		

注胶槽采用“AA”槽

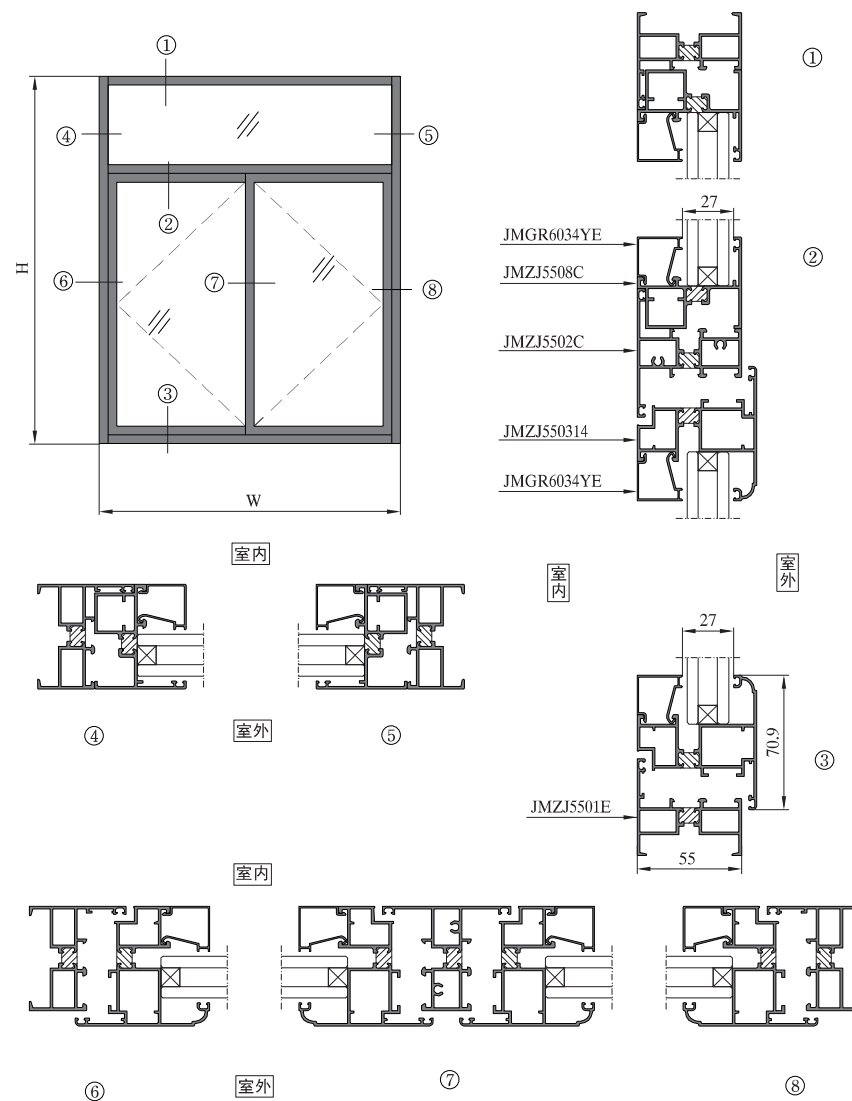

图中所示型材截面、装配、编号、尺寸及重量仅供参考。如有疑问，请向本公司查询。
Information above just for your reference. Please contact us if you have any questions, Thank you!

图中所示型材截面、装配、编号、尺寸及重量仅供参考。如有疑问，请向本公司查询。
Information above just for your reference. Please contact us if you have any questions, Thank you!

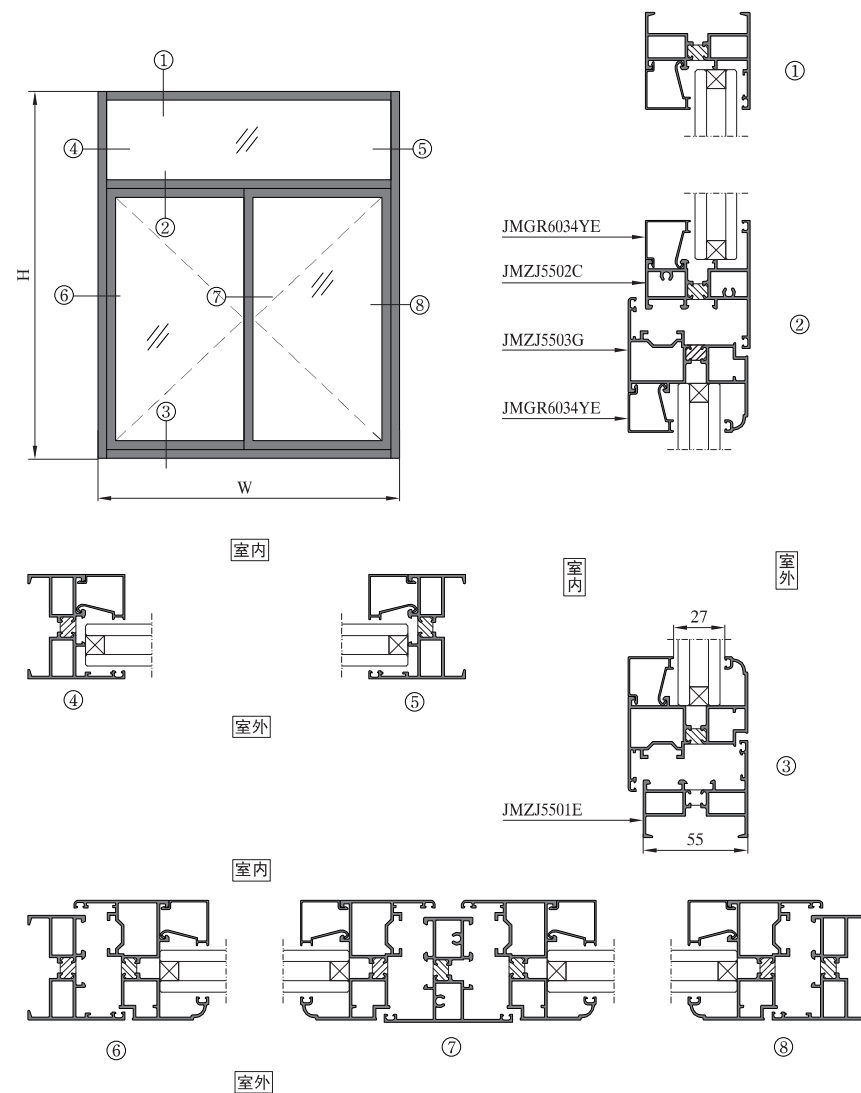
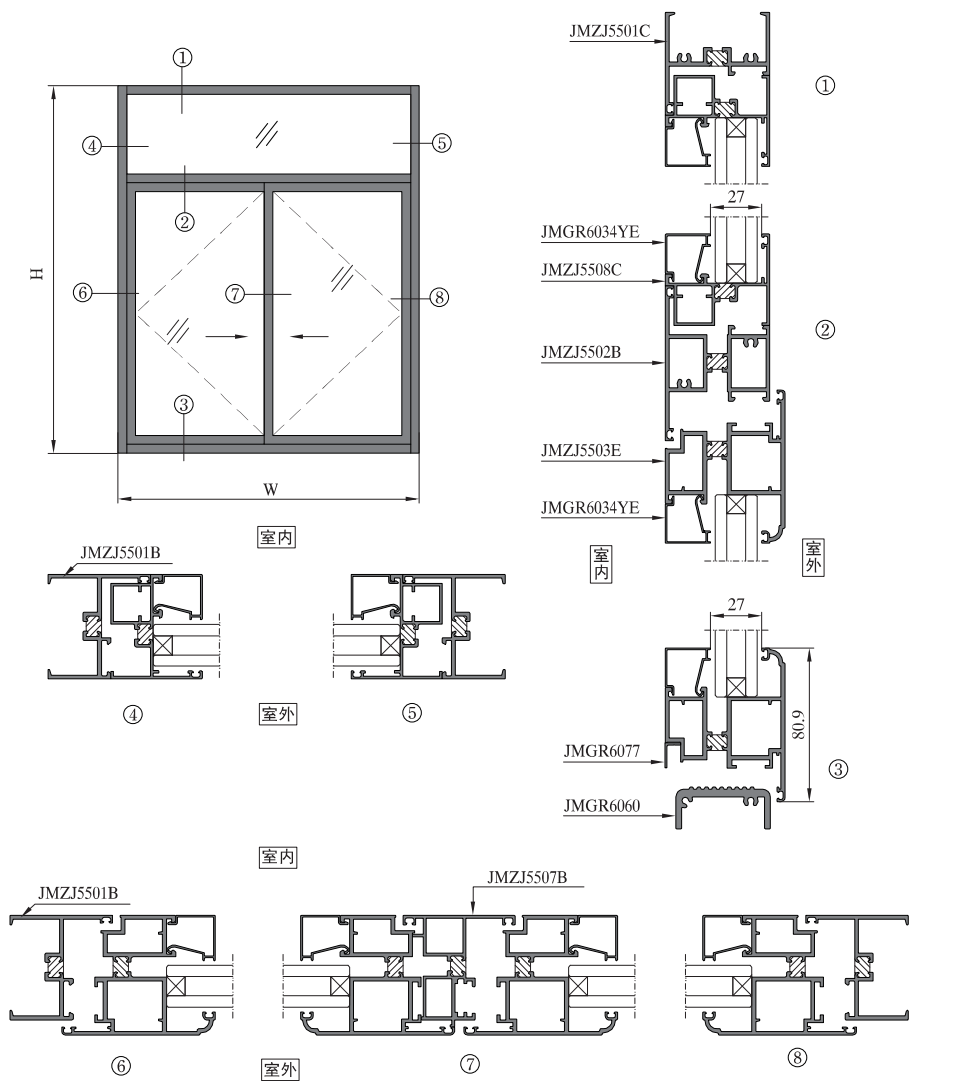

注胶槽采用“AA”槽

图中所示型材截面、装配、编号、尺寸及重量仅供参考。如有疑问，请向本公司查询。
Information above just for your reference. Please contact us if you have any questions, Thank you!

图中所示型材截面、装配、编号、尺寸及重量仅供参考。如有疑问，请向本公司查询。
Information above just for your reference. Please contact us if you have any questions, Thank you!

序号 S/N	型号理论重量 JMA Code & KG/M	型材图 Drawing	序号 S/N	型号理论重量 JMA Code & KG/M	型材图 Drawing	序号 S/N	型号理论重量 JMA Code & KG/M	型材图 Drawing
1	框料 JMZJ550114 0.982kg/m		10	中挺 JMZJ5502B 1.873kg/m		19	内扇 JMZJ5503G 1.347kg/m	
2	框料 JMZJ5501H 0.955kg/m		11	中挺 JMZJ5502P 1.702kg/m		20	压线 JMGR6034 0.257kg/m 带装饰线	
3	框料 JMZJ5501E 1.089kg/m		12	中挺 JMZJ5502F 1.712kg/m		21	压线 JMGR6034AE 0.237kg/m	
4	框料 JMZJ5501D 1.214kg/m		13	中挺 JMZJ5502G 2.087kg/m		22	压线 JMGR6035 T=0.9 0.219kg/m	
5	框料 JMZJ5501B 1.089kg/m		14	中挺 JMZJ5502L 2.508kg/m		23	压线 JMGR6034C 0.247kg/m 带装饰线	
6	框料 JMZJ5501C 1.200kg/m		15	中挺 JMZJ5502A 1.972kg/m		24	压线 JMGR6034YE 0.220kg/m	
7	中挺 JMZJ550214 1.147kg/m		16	外扇 JMZJ550314 1.385kg/m		25	压线 JMGR6034B 0.213kg/m	
8	中挺 JMZJ5502C 1.284kg/m		17	外扇 JMZJ5503A14 1.323kg/m		26	压线 JMGR6034F 0.184kg/m	
9	中挺 JMZJ5502R 1.104kg/m		18	门扇 JMZJ5503E 2.009kg/m		27	压线 JMGR6034QA 0.222kg/m 带装饰线	

注胶槽采用“AA”槽

序号 S/N	型号理论重量 JMA Code & KG/M	型材图 Drawing	序号 S/N	型号理论重量 JMA Code & KG/M	型材图 Drawing	序号 S/N	型号理论重量 JMA Code & KG/M	型材图 Drawing
28	压线 JMGR6034RD 0.218kg/m		37	拼料 JMZJ5506 0.525kg/m		46		
29	压线 JMGR6034A 0.189kg/m		38	门槛 JMGR6060 1.011kg/m		47		
30	压线 JMGR6034AG 0.175kg/m		39	封边 JMGR6077 0.070kg/m		48		
31	底座 JMGR6037B 0.172kg/m		40	角码 JM3824 1.331kg/m		49		
32	压线 JMGR6034YB 0.206kg/m		41	角码 F-50625 1.786kg/m		50		
33	大压线 JMZJ5504H 0.227kg/m		42	角码 JMGR5008A 2.381kg/m		51		
34	外扇假中挺 JMZJ5507B 1.253kg/m		43	角码 JMGR5217 4.264kg/m		52		
35	转换框 JMZJ5508C 0.983kg/m		44	角码 JMGR5270A 2.645kg/m		53		
36	转换框 JMZJ5508B 0.941kg/m		45	角码 GRE5527D 1.329kg/m		54		

 图中所示型材截面、装配、编号、尺寸及重量仅供参考。如有疑问，请向本公司查询。
 Information above just for your reference. Please contact us if you have any questions, Thank you!

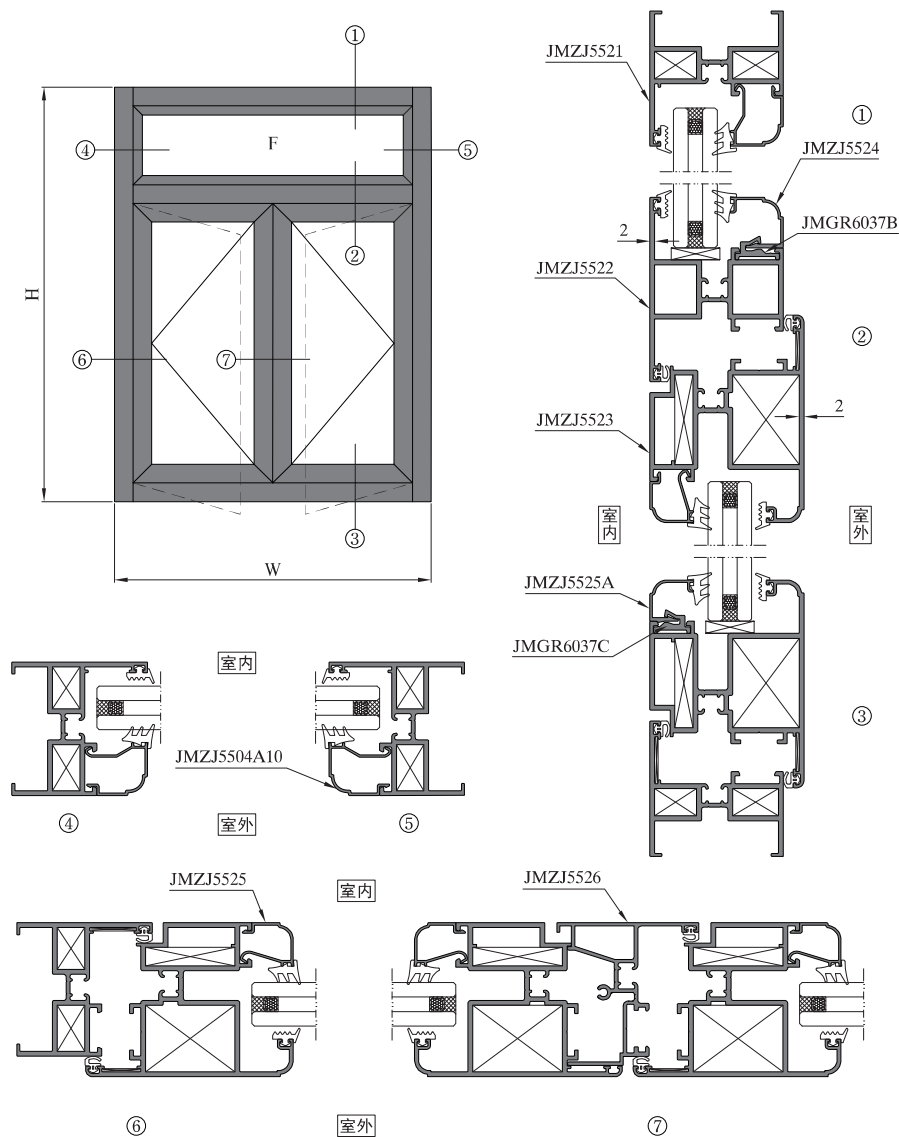

序号 S/N	型号理论重量 JMA Code & KG/M	型材图 Drawing	序号 S/N	型号理论重量 JMA Code & KG/M	型材图 Drawing	序号 S/N	型号理论重量 JMA Code & KG/M	型材图 Drawing
1	框料 JMZJ5521 1.290kg/m		10	压线座 JMGR6037C 0.161kg/m		19		
2	中挺 JMZJ5522 1.534kg/m		11	假中挺 JMZJ5526 1.010kg/m		20		
3	中挺 JMZJ5522A 2.238kg/m		12	角码 F-50625 1.786kg/m		21		
4	扇料 JMZJ5523 2.046kg/m		13	角码 JMGR6059 4.458kg/m		22		
5	压线 JMZJ5524 0.193kg/m		14			23		
6	压线 JMZJ5504A10 0.215kg/m		15			24		
7	压线 JMZJ5525 0.183kg/m		16			25		
8	压线 JMZJ5525A 0.151kg/m		17			26		
9	压线座 JMGR6037B 0.172kg/m		18			27		

注胶槽采用“AA”槽

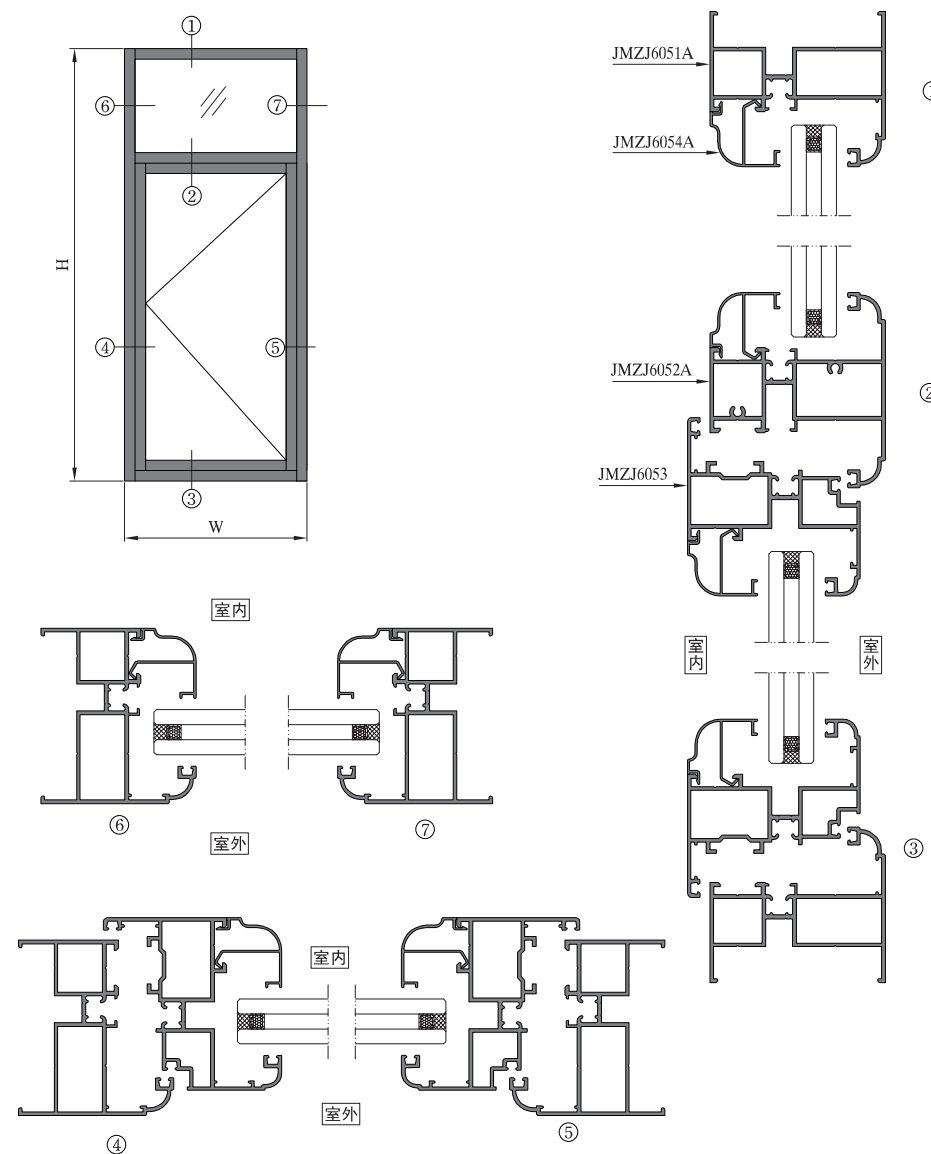
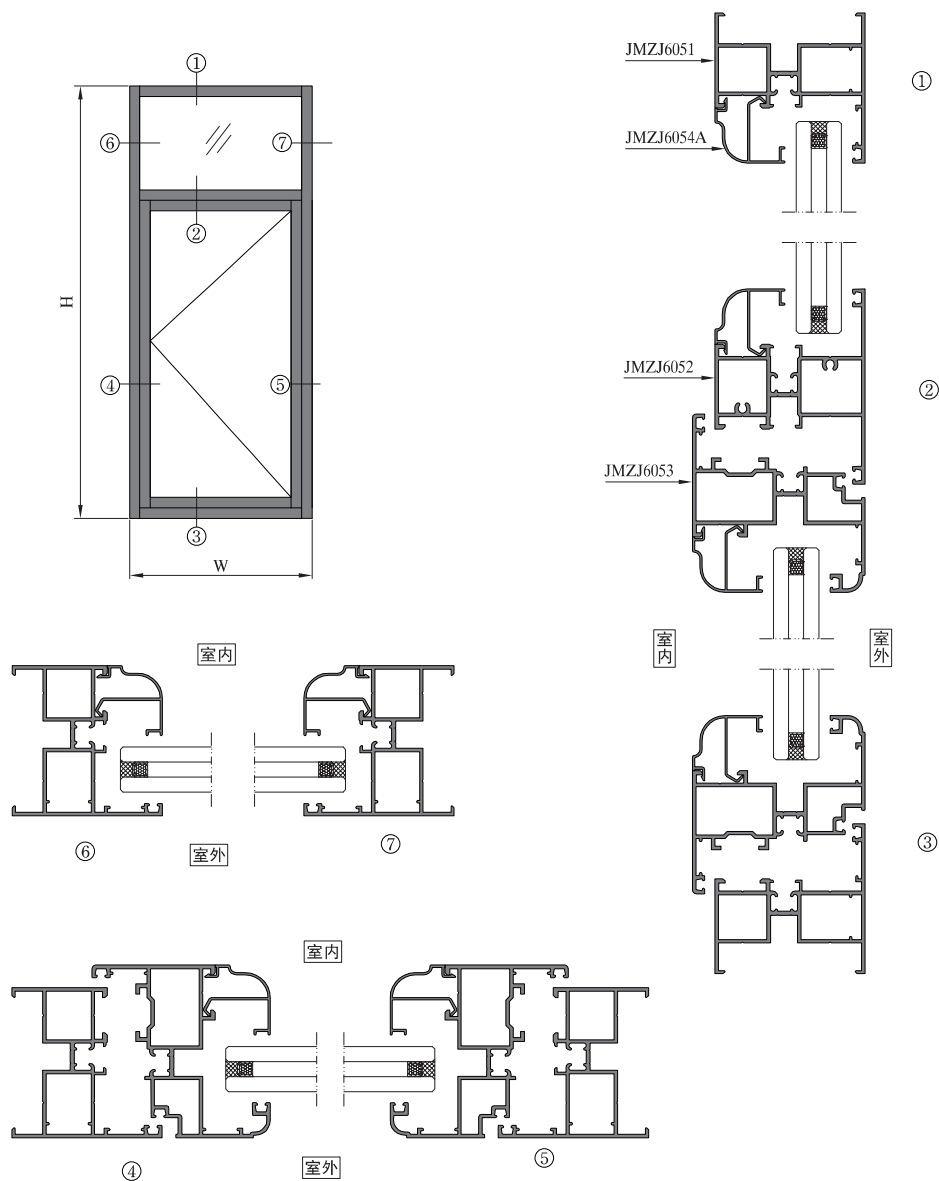

序号 S/N	型号理论重量 JMA Code & KG/M	型材图 Drawing	序号 S/N	型号理论重量 JMA Code & KG/M	型材图 Drawing	序号 S/N	型号理论重量 JMA Code & KG/M	型材图 Drawing
1	框料 JMZJ6051 1.254kg/m		10	中挺 JMZJ6052D 1.888kg/m		19	转角 JMZJ6056 1.207kg/m	
2	框料 JMZJ6051A 1.383kg/m		11	中挺 JMZJ6052E 1.884kg/m		20	转角 JMZJ6056A 1.062kg/m	
3	框料 JMZJ6051B 1.326kg/m		12	扇料 JMZJ6053 1.468kg/m		21	转角 JMZJ6056B 1.354kg/m	
4	框料 JMZJ6051C 1.461kg/m		13	扇料 JMZJ6053A 1.536kg/m		22		
5	框料 JMZJ6051D 1.617kg/m		14	扇料 JMZJ6053C 1.525kg/m		23		
6	中挺 JMZJ6052 1.473kg/m		15	扇料 JMZJ6053D 2.227kg/m		24		
7	中挺 JMZJ6052A 1.651kg/m		16	压线 JMZJ6054 0.217kg/m		25		
8	中挺 JMZJ6052B 1.547kg/m		17	压线 JMZJ6054A 0.238kg/m		26		
9	中挺 JMZJ6052C 1.725kg/m		18	压线 JMZJ6054C 0.244kg/m		27		

图中所示型材截面、装配、编号、尺寸及重量仅供参考。如有疑问，请向本公司查询。
Information above just for your reference. Please contact us if you have any questions, Thank you!

广东坚美铝型材厂(集团)有限公司
Guangdong JMA Aluminium Profile Factory (Group) Co., Ltd.

地址: 中国广东省佛山市南海区大沥凤池工业区 (广佛路大沥往佛山1公里)
ADD: Fengchi Industrial Area, Dali Town, Nanhai District, Foshan City, Guangdong Province, China

佛山坚美铝业有限公司
Foshan JMA Aluminium Co., Ltd.

地址: 广东省佛山市南海区狮山镇桃园西路高新技术开发区南海园
ADD: Nanhai Park, High-new Technology Zone, Tianyuan Road West, Shishan Town, Nanhai District, Foshan City, Guangdong Province, China

邮编(Zip): 528231 电话(Tel): 86-757-85558828 传真(Fax): 86-757-85550238
网址(Website): <http://www.jma.cn> <http://www.jianmei-alu.com>
电子邮箱(E-mail): sales@jma.cn jmmaster@jma.cn dd@jma.cn



坚美铝材
官方网站二维码



坚美铝业微信公众号
微信号: jmagroup