



系统产品篇 I
SYSTEM PRODUCTS PART I

广东坚美建筑科技有限公司
Guangdong JM Construction Technology Co., Ltd.

广东坚美定制门窗系统有限公司
Guangdong JM Custom Door and Window System Co., Ltd.

中国·广东佛山国家高新区南海园松夏工业大道西12号
No.12, Songxia Industrial Avenue West, Nanhai Park, Foshan National High-tech District, Guangdong, China

TEL:0757-8558-8975 www.jma-system.cn



微信服务号
WeChat
service account



微信订阅号
WeChat
subscription account

建筑门窗系统 解决方案服务商

SERVICE PROVIDER FOR BUILDING DOOR AND WINDOW
SYSTEM SOLUTIONS

温馨提示：本册所示资料、参数仅供参考，本公司保留修改和解释的权利！

Tips: The information and parameters shown in this book are for reference only. Our company reserves the right to modify/revise/amend and interpretation.

全国房地产技术应用 **TOP10**
核心竞争力供应商
NATIONAL REAL ESTATE TECHNOLOGY APPLICATION
CORE COMPETITIVENESS SUPPLIER TOP10

CONTENTS

建筑门窗系统
解决方案服务商

SERVICE PROVIDER FOR BUILDING DOOR AND WINDOW
SYSTEM SOLUTIONS

INTRODUCTION OF JM SYSTEM 坚美门窗系统介绍

关于我们 ABOUT JM	03
发展历程 DEVELOPMENT HISTORY	05
门窗系统服务商 DOORS & WINDOWS SYSTEM SERVICE PROVIDER	07
系统保障 SYSTEM ASSURANCE	09
产品检测认证 PRODUCT TESTING & CERTIFICATION	11
标准引领 STANDARDS	13
知识产权 INTELLECTUAL PROPERTY	15

CLIMATIC ZONES IN CHINA 中国建筑气候区划图

17

PROVISIONS ON THERMAL PERFORMANCE OF EXTERIOR WINDOWS OF RESIDENTIAL BUILDINGS 居住建筑外窗热工性能规定

19

TECHNICAL SCHEME OF JM DOOR AND WINDOW SYSTEM 坚美门窗系统技术方案

21

外平开窗系统 CASEMENT WINDOW	23
内平开窗系统 TILT-AND-TURN WINDOW	29
平开门系统 HINGED DOOR	35
推拉窗系统 SLIDING WINDOW	39
推拉门系统 SLIDING DOOR	43
提升推拉门系统 LIFT-AND-SLIDE DOOR	49

ABOUT JM

关于我们

总部仓储供应中心

3.6万m²

36,000 m²
HEAD OFFICE
STORAGE AND SUPPLY CENTER

门窗及材料检测设备

100+台

100+
DOORS, WINDOWS AND MATERIALS
TESTING EQUIPMENT

年产能

150万m²

1.5 MILLION m²
ANNUAL CAPACITY

技术研发人员

200+

200+
TECHNICAL RESEARCH AND
DEVELOPMENT PERSONNEL

广东坚美建筑科技有限公司

坚美门窗系统

坚美建筑科技(坚美门窗系统)专业从事门窗系统的研发、设计,为建筑项目门窗应用输出标准和系统服务,为顾客提供全方位的门窗系统解决方案。

坚美门窗系统源自于2002年成立的坚美门窗加工厂及2008年为承担“十一五”及“十二五”国家科技支撑计划门窗项目而成立的坚美门窗系统研发中心,现有专业技术研发团队200多人。

坚美门窗系统根据不同区域环境、气候特征及项目需求,研发出性能优越、性价比高、功能完备的90多款门窗系统产品,实现中国建筑气候区域(严寒、寒冷、夏热冬冷、夏热冬暖、温和地区)全覆盖,同时在绿色建筑、低能耗建筑、被动房、岛礁用窗等高技术要求项目拥有成功经验。

GUANGDONG JM CONSTRUCTION TECHNOLOGY CO., LTD.

JM SYSTEM

JM System specializes in the development and design of doors and windows system, for the construction of doors and Windows application output standards and system services, to provide customers with a full range of doors and windows system solutions.

JM System originated from JM Door and Window Processing Factory established in 2002 and JM Door and Window System Research and Development Center established in 2008 to undertake the "11th Five-Year Plan" and "12th Five-Year Plan" national science and technology support programs. Currently, there are more than 200 professionals in the technology research and development teams.

JM System has developed more than 90 kinds of window system products with superior performance, low price and complete functions according to different regional environment, weather characteristics and requirements. It has achieved full coverage of China's building weather areas (cold, cold, hot summer and cold winter, hot summer and warm winter, mild areas). simultaneously/concurrently has successful experience in high-tech projects such as green buildings, low-energy buildings, passive buildings, window for islands and reefs.

DEVELOPMENT HISTORY

发展历程

JM System
坚美门窗系统

2002 LAUNCH

启程

成立坚美门窗加工厂。

JM Door and Window Processing Factory is established.



2008 R&D

研发

成立门窗系统研发团队，并先后承担“十一五”和“十二五”国家科技支撑计划门窗系统项目研发任务。

Set up a research and development team for door and window systems, and successively undertake the "11th Five-Year Plan" and the "12th Five-Year Plan" national science and technology support plan door and window system project research and development tasks.

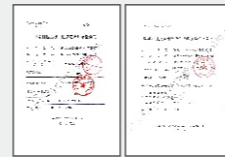

2012 CHANGE

蜕变

创立自主品牌的坚美门窗系统，并推出第一代系统产品。

Establish independent brand JM system, and launch the first generation of system products.



2018 HONOR

荣誉

荣获中国建筑金属结构协会评定的《门窗行业十大首选品牌》。

Won the "Top Ten Preferred Brands in door and Window Industry" assessed by China Building Metal Structure Association.



2020 GUIDE

引领

推出新一代系统产品，市场影响进一步扩大。

A new generation of system products was launched, which further expanded the market influence.



2021 FORWARD

奋进

坚美系统新总部基地落成，建有行业先进的供应物流中心、门窗创新研发中心、国家级门窗实验室。

JM System's new head office base completed with industrial's advanced supply and logistics center, door and window innovation research and development center, national door and window laboratory.



2022 FUTURE

致远

秉承“创新、品牌、完美、共赢”的发展理念，携手合作伙伴提供更优质服务，为建筑项目门窗增值。

Adhere to the "Innovation, Brand, Perfect, Win-win" development concept. Join hands with partners to provide better service and add value to the doors and Windows of construction projects.

DOORS & WINDOWS SYSTEM SERVICE PROVIDER

门窗系统服务商

1. 系统研发-Research & Development

创研中心 Research center
产品研发 Research & Development
工艺标准 Technology standard
知识产权 Intellectual property

4. 系统服务-SERVICE

产品应用解决方案 Product application solutions
样板房设计及提供 Model house design & provision
仓储物流供应服务 Logistics supply service
培训服务 (订货、生产、施工、售后)
Training services

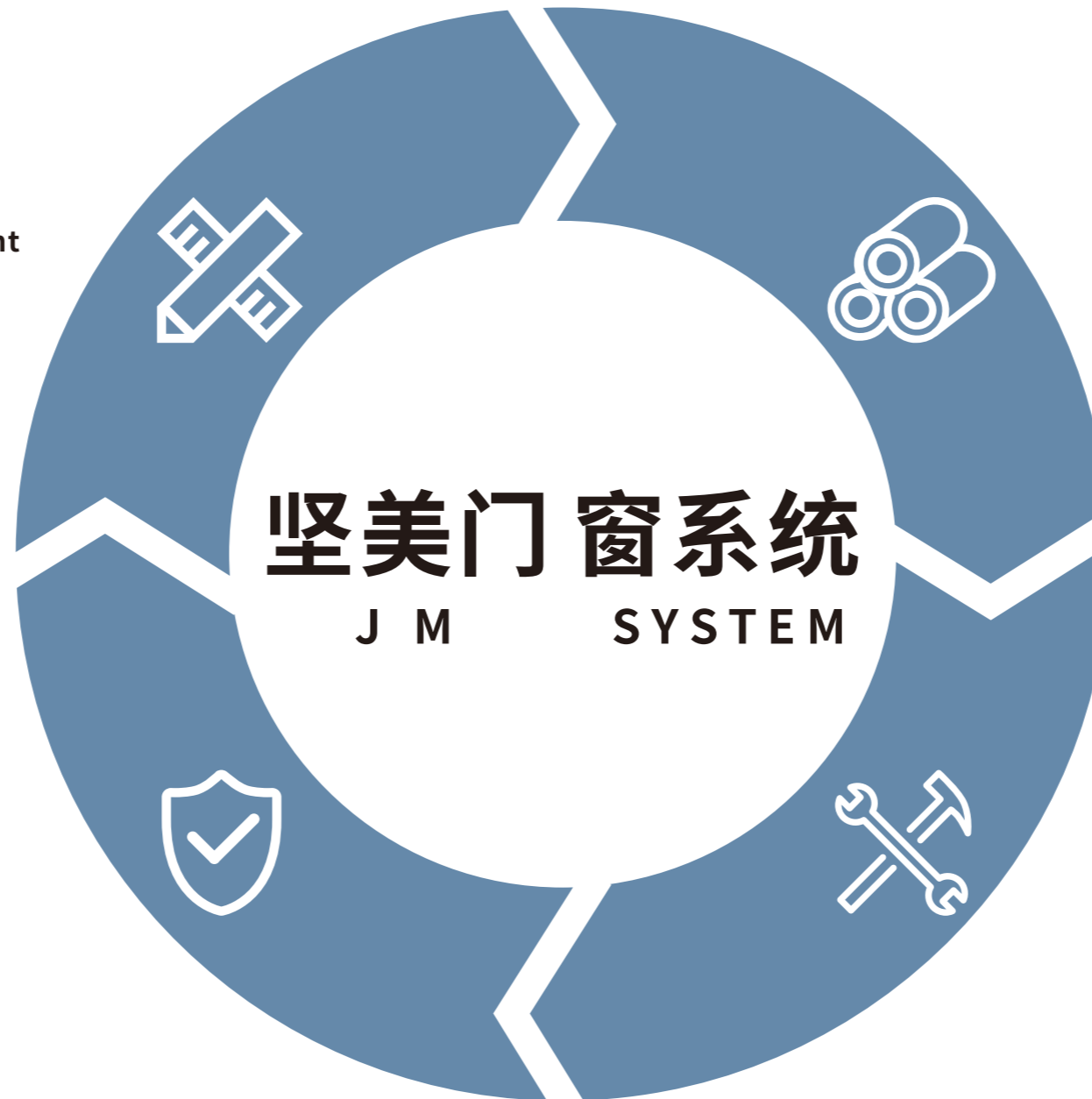

2. 系统材料及配套-Materials & Accessories

铝合金型材 Aluminum profile
玻璃应用 Glass application
五金系统 Hardware system
密封系统 Sealing system
配套件系统 Matching parts system

3. 系统保障-SYSTEM ASSURANCE

产品检测认证 Product testing & certification
制造过程监管 Manufacturing process supervision
施工过程监管 Construction process supervision
售后服务保障 AFTER SALES GUARANTEE

SYSTEM ASSURANCE

系统保障

— 坚美检测中心被认定为国家认可实验室，公司现有100多台门窗及材料检测设备，为产品开发和应用提供科学的数据支持。

JM Testing Center is recognized as a nationally recognized laboratory. Our company has more than 100 doors and windows and materials testing equipments. Providing scientific data support for product development and application.



门窗性能检测

Windows & Doors Performance Testing

门窗三性检测
Three-dimensional Test of Doors and Windows

反复启闭检测
Repeated Opening and Closing Detection

隔声性能检测
Sound Insulation Performance Test

保温性能检测
Insulation Performance Test

采光性能检测
Daylighting Performance Test

遮阳性能检测
Sunshade Performance Test

力学性能检测
Mechanical Performance Test

尺寸测量
Dimensional Measurement

材质分析
Material Analysis

力学性能检测
Mechanical Performance Test

化学性能检测
Chemistry Performance Test

光学性能检测
Optical Performance Testing

热学性能检测
Thermal Performance Testing

耐候性能检测
Weather Resistance Performance Test

耐久性能检测
Durability Performance Test

门窗构件检测

Windows & Doors Component Inspection

门窗性能检测(部分)

Performance Testing of Doors and Windows (Part)



门窗气密、水密、抗风压性能
实验室检测室检测设备
Air tightness, water tightness and wind pressure resistance
of doors and windows
Testing Equipment for Laboratory Testing Room



门窗保温性能检测设备中控台
Center console of door and window thermal insulation
performance testing equipment



门窗空气隔声性能检测
Air sound insulation performance test
of doors and windows



门窗采光性能检测设备
Detection equipment for lighting performance of
doors and windows



门窗耐久性能单臂式检测设备
Single arm type testing equipment for durability
of doors and windows



门窗耐久性能机械手检测设备
Mechanical arm detection equipment for durability of
doors and windows



门窗构件检测(部分)

Inspection of Door and Window Components (Part)



恒定湿热试验箱
Constant humidity test chamber



露点仪
Dew point meter



高低温交替湿热试验箱
High and Low Temperature Alternating
Humid Heat est Chamber



密封胶相容性试验箱
Sealant Compatibility Test Chamber



耐辐照检测机
Radiation-resistant detector



耐紫外辐照试验机
Ultraviolet radiation resistant
testing machine



热老化试验箱
Thermal aging test chamber

STANDARDS

标准引领

30多项
标准MORE THAN
30 STANDARDS

先后主编、主笔GB8478《铝合金门窗》、JGJ214《铝合金门窗工程技术规范》、GB39529《系统门窗通用技术条件》、GB5237《铝合金建筑型材》等建筑(系统)门窗相关国家、行业标准规范30多项,为门窗行业的高质量发展贡献坚美力量。

Edited and wrote GB8478 "Aluminum Doors and Windows", JGJ214 "Technical Specifications for Aluminum Doors and Windows Engineering", GB39529 "General Technical Conditions for System Doors and Windows", GB5237 "Aluminum Alloy Building Profiles" and other related countries and more than 30 Industrials standards, contributing to the high-quality development of doors and windows in industrials.

2017年

《建筑系统门窗技术导则》主要编写单位

"Technical Guidelines for Doors and Windows of Building Systems" editor in chief



2019年

建筑外窗新型标准化安装节点征集活动
外窗标准化安装荣誉单位

Solicitation of New Standardized Installation Nodes for Building Exterior Windows
Honorary Unit for Standardized Installation of External Windows



2019年

全国建筑幕墙门窗标准化工作
先进委员单位

Standardization of Curtain Wall Doors and Windows in China
Advanced Committee Member Unit



标准号 Standard number	标准名称 Standard name
RISN-TG047-2023	建筑门窗安装技术导则 Guideline for installation of windows and external doors
GB/T 39968-2021	建筑用通风百叶窗技术要求 Technical specification of ventilation louvers for building
GB/T 39866-2021	建筑门窗附框技术要求 Technical requirement of appendent frame for window and door in building
GB/T 5824-2021	建筑门窗洞口尺寸系列 Size system of opening for windows and doors in building
GB/T 39529-2020	系统门窗通用技术条件 General technical requirements for systematic windows and doors
GB/T 8478-2020	铝合金门窗 Aluminium windows and doors
GB/T 8484-2020	建筑外门窗保温性能检测方法 Test method for thermal insulating performance for building exterior doors and windows
GB/T 38252-2019	建筑门窗耐火完整性试验方法及判定要求 Test method of fire-resistant integrity for building windows and doors
GB/T 15227-2019	建筑幕墙气密、水密、抗风压性能检测方法 Test method of air permeability, watertightness, wind load resistance performance for curtain walls
GB/T 38388-2019	建筑光伏幕墙采光顶检测方法 Test method of solar PV system for curtain wall and skylight of building
GB/T 7106-2019	建筑外门窗气密、水密、抗风压性能检测方法 Test methods of air permeability, watertightness, wind load resistance performance for building external windows and doors
GB/T 34555-2017	建筑采光顶气密、水密、抗风压性能检测方法 Test method of air permeability, watertightness, wind load resistance performance for building skylight system
RISN-TG026-2016	建筑系统门窗技术导则 Technical guideline for system window
GB/T31433-2015	建筑幕墙、门窗通用技术条件 General specification for building curtain walls, windows and doors

•
•
•

INTELLECTUAL PROPERTY

知识产权

- 自主研发的“隔热铝合金窗”、“海岛建设用耐候节能铝合金门窗”先后获评“国家重点新产品”、“全国建材行业技术革新奖”
- 坚美被动式建筑用窗系统通过德国PHI认证 (PHB级)
- 坚美高性能推拉窗系统获评“中国门窗幕墙创新·星品奖”
- 坚美“三防”门窗系统”产品, 获评第四届建筑门窗幕墙行业金轩奖“技术研发创新产品”

· The independently developed "insulated aluminum alloy windows" and "Weatherproof and Energy-Saving Aluminum Alloy Doors and Windows For Island Construction" were successively awarded "National Key New Products" and "National Building Materials Industrials Technological Innovation Award"

- JM Passive Building Window System Passed PHB Certification in Germany
- JM High Performance Sliding Window System won "China Door Window Curtain Wall Innovation Star Award"
- JM's "Three Preventions" Door and Window System won the 4th Industrials Golden Xuan Award for Building Door and Window Curtain Wall "Technological R&D and Innovative Products"



66件著作权

信息系统软件著作权33件
作品著作权33件
赋能合作伙伴提质增效.....

66 COPYRIGHTS
33 pieces of information system software copyright
33 copyright works
Enabling Partners to Improve Quality and Increase Efficiency

200多件专利

国际专利7项
发明专利13项
实用新型专利90多项.....

MORE THAN 200 PATENTS
7 International Patents
13 Invention Patents
More than 90 Utility Model Patents.....

专利号 Patent number	专利名称 Patent Name	专利类型 Patent Type
2015210472	一种密封性推拉装置 Sealing push-pull device	巴黎公约 (澳大利亚) Paris Convention (Australia)
PCT/CN2015/079344	一种门窗 Door and window	PCT (欧洲) PCT (Europe)
PCT/CN2016/070694	推拉装置 Push-pull device	PCT PCT
PCT/CN2016/0706953258052	一种推拉装置的排水装置 Drainage device of push-pull device	PCT (欧洲) PCT (Europe)
PCT/CN2018/080451	推拉装置的密封机构 Sealing mechanism of push-pull device	PCT (澳大利亚) PCT (Australia)
PCT/CN2018/079400	一种推拉门窗限位防脱落装置及一种防脱落密封推拉门窗 Limit anti-dropping device for sliding door and window and anti-dropping sealed sliding door and window	PCT PCT
PCT/CN2018/080438	一种地弹门 Ground bounce door	PCT (加拿大) PCT (Canada)
ZL201410300153.8	一种门窗 Door and window	发明专利 Partent for Invention
ZL201410391597.7	一种高密封性推拉门窗 High-sealing sliding door and window	发明专利 Partent for Invention
ZL201510083579.7	一种推拉装置的排水装置 Drainage device of push-pull device	发明专利 Partent for Invention
ZL201710347273.7	推拉装置的密封机构 Sealing mechanism of push-pull device	发明专利 Partent for Invention

•
•

CLIMATIC ZONES IN CHINA

中国建筑气候区划图



严寒地区

Severe Cold Region

[建筑门窗基本要求]

须充分满足保温、采光、防风、防结露、耐低温等要求。

Basic requirements for building doors and windows

It must fully meet the requirements of heat preservation, lighting, wind prevention, condensation prevention, low temperature resistance, etc.

寒冷地区

Cold Zone

[建筑门窗基本要求]

须满足保温、采光、防风沙、防结露、防雾霾、耐低温等要求，部分地区应兼顾隔热。

Basic requirements for building doors and windows

It must meet the requirements of heat preservation, lighting, wind and sand prevention, condensation prevention, haze prevention, low temperature resistance and other requirements, and heat insulation should be considered in some areas.

温和地区

Temperate Zone (Mild Summer & Winter)

[建筑门窗基本要求]

须满足湿季防雨、防潮等要求，可不考虑隔热，通过合理的设计和应用，使湿季有较好自然通风。

Basic requirements for building doors and windows

Must meet the wet season rain, moisture and other requirements, may not consider heat insulation, through reasonable design and application, make the wet season have better natural ventilation.

夏热冬冷地区

Tropical Zone (Mild Summer and Cold Winter)

[建筑门窗基本要求]

须满足隔热、遮阳、通风、防雨、抗台风等要求，应适当兼顾保温。

Basic requirements for building doors and windows

It must meet the requirements of heat insulation, sunshade, ventilation, rainproof, typhoon resistance, etc., should give due consideration to heat preservation.

夏热冬暖地区

Mediterranean Zone (Hot Summer and Mild winter)

[建筑门窗基本要求]

须充分满足隔热、遮阳、通风、防雨、抗台风等要求，可不考虑保温。

Basic requirements for building doors and windows

It must fully meet the requirements of heat insulation, sunshade, ventilation, rainproof, typhoon resistance, etc., heat preservation may not be considered.

南海岛礁

Islands and Reefs in South China Sea

[气候特征]

南海岛礁具有高温、高湿、高盐雾，太阳辐射强，台风频发，海水冲刷等特殊海洋环境气候特征。

[建筑门窗基本要求]

须满足隔热、耐腐蚀、抗强台风、高水密、高气密等性能要求。

Climatic characteristics

South China Sea reefs are characterized by climate characteristics of special marine environment such as high temperature, high humidity, high salt fog, strong solar radiation, frequent typhoons and seawater scouring.

Basic requirements for building doors and windows

It must meet the performance requirements of heat insulation, corrosion resistance, strong typhoon resistance, high water tightness, high air tightness, etc.

居住建筑外窗热工性能规定

PROVISIONS ON THERMAL PERFORMANCE OF EXTERIOR WINDOWS OF RESIDENTIAL BUILDINGS

附表A1 严寒地区居住建筑外窗热工性能限值

Annex Table A1 Thermal Performance Limits of Exterior Windows of Residential Buildings in Severe Cold Areas

外窗 Exterior Window	传热系数 K [W/(m ² . K)] Heat Transfer Coefficient K [W/(m ² . K)]		
	≤3层建筑 ≤3-floor building	>3层建筑 >3-floor building	
严寒A区 Cold Area A	①窗墙面积比≤0.30	≤1.40	≤1.60
	0.30<窗墙面积比≤0.45	≤1.40	≤1.60
严寒B区 Cold Area B	窗墙面积比≤0.30	≤1.40	≤1.80
	0.30<窗墙面积比≤0.45	≤1.40	≤1.60
严寒C区 Cold Area C	窗墙面积比≤0.30	≤1.60	≤2.00
	0.30<窗墙面积比≤0.45	≤1.40	≤1.80

附表A2 寒冷地区居住建筑外窗热工性能限值

Annex Table A2 Thermal Performance Limits for Exterior Windows of Residential Buildings in Cold Areas

外窗 Exterior Window	传热系数 K [W/(m ² . K)] Heat Transfer Coefficient K [W/(m ² . K)]		太阳得热系数SHGC Solar Thermal Coefficient SHGC	
	≤3层建筑 ≤3-floor building	>3层建筑 >3-floor building		
寒冷A区 Cold Area A	窗墙面积比≤0.30	≤1.80	≤2.20	—
	0.30<窗墙面积比≤0.50	≤1.50	≤2.00	—
寒冷B区 Cold Area B	窗墙面积比≤0.30	≤1.80	≤2.20	—
	0.30<窗墙面积比≤0.50	≤1.50	≤2.00	②夏季东西向≤0.55

注:本表自《建筑节能与可再生能源利用通用规范》GB 55015-2021

Note: This table is from GB 55015-2021 "General Code for Building Energy Conservation and Renewable Energy Utilization"

- ① 窗墙面积比 Window-wall ratio ② 夏季东西向 Summer East-west Direction ③ 夏季 Summer
④ 冬季 Winter ⑤ 东西向外窗 East-west exterior window

附表A3 夏热冬冷地区居住建筑外窗热工性能限值

Annex Table A3 Thermal Performance Limits for Exterior Windows of Residential Buildings in Hot Summer and Cold Winter Areas

外窗 Exterior Window	传热系数 K [W/(m ² . K)] Heat Transfer Coefficient K [W/(m ² . K)]	太阳得热系数SHGC (东、西向/南向) Solar Thermal Coefficient SHGC (East, West/South)	
夏热冬冷A区 Hot Summer and Cold Winter Area A	窗墙面积比≤0.25	≤2.80	—
	0.25<窗墙面积比≤0.40	≤2.50	③夏季≤0.4/—
	0.40<窗墙面积比≤0.60	≤2.00	夏季≤0.25/④冬季≥0.50
夏热冬冷B区 Hot Summer and Cold Winter Area B	窗墙面积比≤0.25	≤2.80	—
	0.25<窗墙面积比≤0.40	≤2.80	夏季≤0.40/—
	0.40<窗墙面积比≤0.60	≤2.50	夏季≤0.25/冬季≥0.50

附表A4 夏热冬暖地区居住建筑外窗热工性能限值

Annex Table A4 Thermal Performance Limits for Exterior Windows of Residential Buildings in Hot Summer and Warm Winter Areas

外窗 Exterior Window	传热系数 K [W/(m ² . K)] Heat Transfer Coefficient K [W/(m ² . K)]	太阳得热系数SHGC (西向/东、南向/北向) Solar Thermal Coefficient SHGC (West/East, South/North)	
夏热冬暖A区 Hot Summer and Warm Winter Area A	窗墙面积比≤0.25	≤3.00	≤0.35/≤0.35/≤0.35
	0.25<窗墙面积比≤0.35	≤3.00	≤0.30/≤0.30/≤0.35
	0.35<窗墙面积比≤0.40	≤2.50	≤0.20/≤0.30/≤0.35
夏热冬暖B区 Hot Summer and Warm Winter Area B	窗墙面积比≤0.25	≤3.50	≤0.30/≤0.35/≤0.35
	0.25<窗墙面积比≤0.35	≤3.50	≤0.25/≤0.30/≤0.30
	0.35<窗墙面积比≤0.40	≤3.00	≤0.20/≤0.30/≤0.30

附表A5 温和地区居住建筑外窗热工性能限值

Annex Table A5 Thermal Performance Limits for Exterior Windows of Residential Buildings in Mild Areas

外窗 Exterior Window	传热系数 K [W/(m ² . K)] Heat Transfer Coefficient K [W/(m ² . K)]	太阳得热系数SHGC (东、西向/南向) Solar Thermal Coefficient SHGC (East, West/South)	
温和A区 Mild Area A	窗墙面积比≤0.20	≤2.80	—
	0.20<窗墙面积比≤0.40	≤2.50	—/冬季≥0.50
	0.40<窗墙面积比≤0.50	≤2.00	—/冬季≥0.50
温和B区 Mild Area B	⑤东西向外窗	≤4.00	夏季≤0.40/—

坚美门窗系统产品 JM SYSTEM PRODUCTS

从气候区划图出发,了解该区域建筑门窗基本要求
持续提升产品内涵和细化产品类别

Starting from the climate zoning map, understand the basic requirements of building doors and windows in this area
Continuous enhance Product Connotation and Refinement of Product Category

系统 SYSTEM	系列 SERIES	隔热条宽度 WIDTH OF HEAT INSULATION STRIP	玻璃配置 GLASS CONFIGURATION	保温性能 [W/(m ² ·K)] INSULATION PERFORMANCE	对应 能耗等级 ENERGY EFFICIENCY INDEX	水密性能 等级 WATER TIGHTNESS	气密性能 等级 AIR TIGHTNESS	抗风压性能 等级 WIND PRESSURE RESISTANCE	隔声性能 (dB) SOUND INSULATION PERFORMANCE	可配套 耐火完整性 (t/min) FIRE INTEGRITY	开启扇宽度范围 WIDTH RANGE OF OPENING LEAF	开启扇高度范围 HEIGHT RANGE OF OPENING LEAF	五金承重 HARDWARE BEARING	最大开启角度 MAXIMUM OPENING ANGLE
外平开窗系统 CASEMENT WINDOW	坚美系统70系列 外平开窗	30	6Low-e+12Ar+6+19Ar +6双暖边	2.0	① 低能耗	6	8	9	37	60	400mm-720mm	800mm-1500mm	60kg	88°
	坚美系统75系列 外平开窗	35	6Low-e+12Ar+6+19Ar +6双暖边	1.8	低能耗	6	8	9	37	60	400mm-720mm	800mm-1500mm	60kg	88°
	坚美系统80系列 外平开窗	39	6Low-e+12Ar+6+19Ar +6Low-e双暖边	1.4	② 超低能耗	6	8	9	38	60	400mm-720mm	800mm-1500mm	60kg	88°
	坚美系统95系列 外平开窗	54	6Low-e+12Ar+6+19Ar +6Low-e双暖边	1.2	超低能耗 近零能耗	6	8	9	40	60	400mm-720mm	800mm-1500mm	60kg	88°
	坚美系统105系列 外平开窗	64	6Low-e+12Ar+6+19Ar +6Low-e双暖边	0.8	③ 近零能耗	6	8	9	42	60	400mm-720mm	800mm-1500mm	60kg	88°
内平开窗系统 TILT-AND-TURN WINDOW	坚美系统70系列 内平开窗	30	6Low-e+12Ar+6+19Ar +6双暖边	2.0	低能耗	6	8	9	37	60	390mm-1200mm	600mm-1800mm	100kg	90°
	坚美系统75系列 内平开窗	35	6Low-e+12Ar+6+19Ar +6双暖边	1.8	低能耗	6	8	9	37	60	390mm-1200mm	600mm-1800mm	100kg	90°
	坚美系统80系列 内平开窗	39	6Low-e+12Ar+6+19Ar +6双暖边	1.4	超低能耗	6	8	9	38	60	390mm-1200mm	600mm-1800mm	100kg	90°
	坚美系统95系列 内平开窗	54	6Low-e+12Ar+6+19Ar +6Low-e双暖边	1.2	超低能耗 近零能耗	6	8	9	40	60	390mm-1200mm	600mm-1800mm	100kg	90°
	坚美系统105系列 内平开窗	64	6Low-e+12Ar+6+19Ar +6Low-e双暖边	0.8	近零能耗	6	8	9	42	60	390mm-1200mm	600mm-1800mm	100kg	90°
平开门系统 HINGED DOOR	坚美系统70系列 外平开门	30	6Low-e+12Ar+6+12Ar +6暖边	2.0	低能耗	6	8	9	35	/	850mm-1000mm	2200mm-2400mm	120kg	110°
	坚美系统75系列 外平开门	35	6Low-e+12Ar+6+12Ar +6暖边	1.8	低能耗	6	8	9	35	/	850mm-1000mm	2200mm-2400mm	120kg	110°
	坚美系统80系列 外平开门	39	6Low-e+12Ar+6+12Ar +6Low-e双暖边	1.4	超低能耗	6	8	9	36	/	850mm-1000mm	2200mm-2400mm	120kg	110°
	坚美系统105系列 外平开门	64	6Low-e+12Ar+6+12Ar +6Low-e暖边	0.8	近零能耗	6	8	9	40	/	850mm-1000mm	2200mm-2400mm	120kg	110°
推拉窗系统 SLIDING WINDOW	坚美系统100系列 推拉窗	30	6Low-e+12Ar+6	2.1	低能耗	5	8	9	26	/	450mm-1000mm	600mm-1600mm	≤120kg	/
推拉门系统 SLIDING DOOR	坚美系统150系列 推拉门	30	6Low-e+12Ar+6+12Ar +6暖边	1.6	低能耗	6	8	9	31	/	900mm-1400mm	2200mm-2600mm	≤200kg	/
			6Low-e+12Ar+6 暖边	2.0	低能耗	29			/	/				
	坚美系统170系列 推拉门	39	6Low-e+12Ar+6+12Ar +6暖边	1.6	低能耗	6	8	9	32	/	900mm-1400mm	2200mm-2600mm	≤200kg	/
			6Low-e+12Ar+6+12Ar +6Low-e暖边	1.4	超低能耗				32	/				/
提升推拉门系统 LIFT-AND-SLIDE DOOR	坚美系统150系列 提升推拉门	30	6Low-e+12Ar+6+12Ar +6暖边	1.6	低能耗	6	8	9	31	/	1200mm-1800mm	2200mm-2700mm	≤300kg	/
			6Low-e+12Ar+6暖边	2.0	低能耗				29	/				/
	坚美系统170系列 提升推拉门	39	6Low-e+12Ar+6+12Ar +6 暖边	1.6	低能耗	6	8	9	32	/	1200mm-1800mm	2200mm-2700mm	≤300kg	/
			6Low-e+12Ar+6+12Ar +6Low-e 暖边	1.4	超低能耗				32	/				/

① 低能耗 Low Energy Consumption

② 超低能耗 Ultra Low Energy Consumption

③ 近零能耗 Near Zero Energy Consumption



坚美系统70系列 外平开窗 70-CASEMENT WINDOW

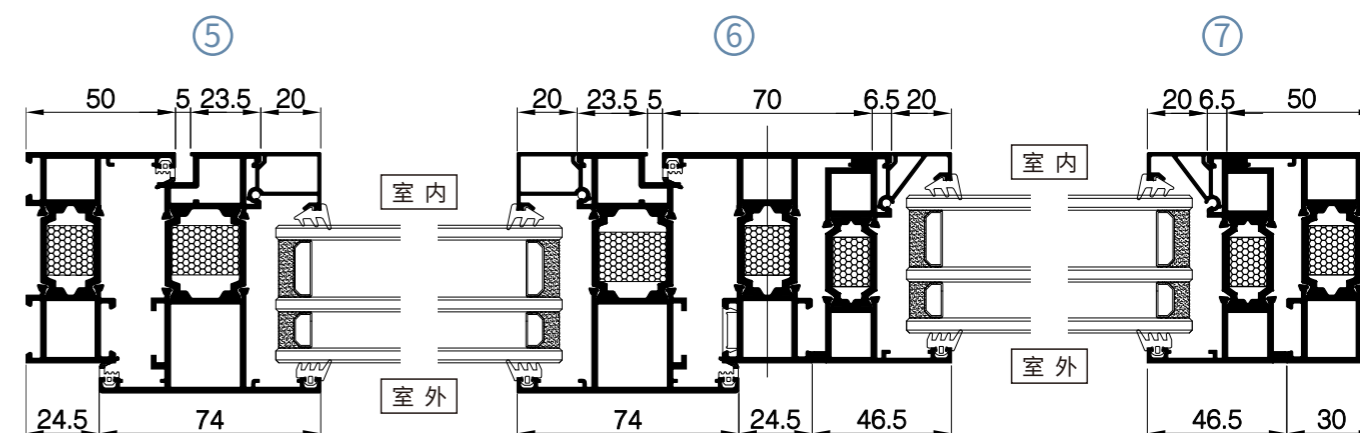
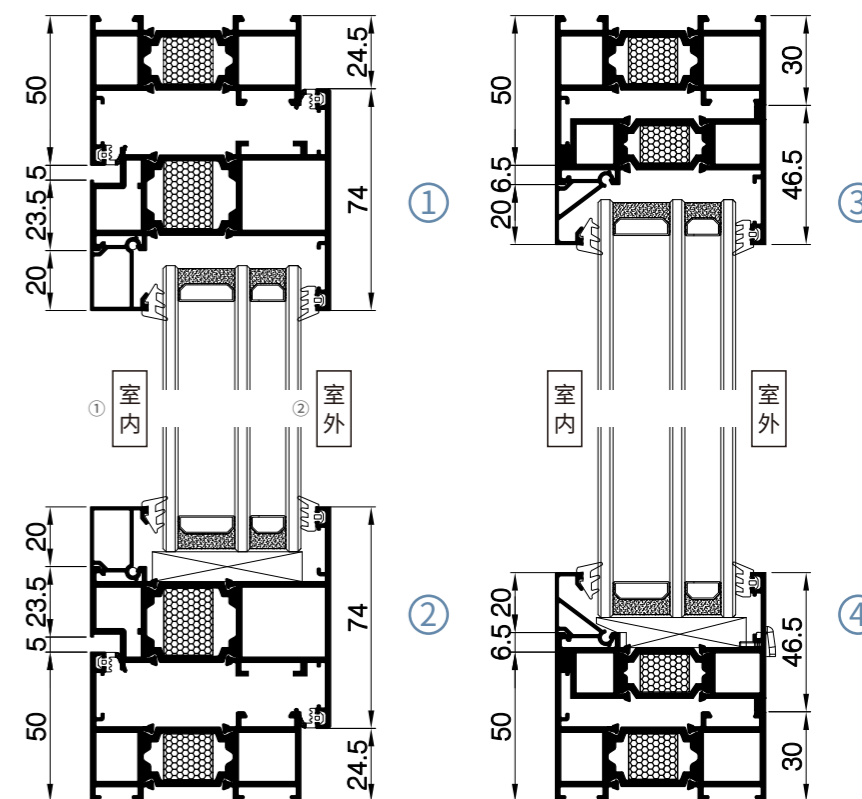
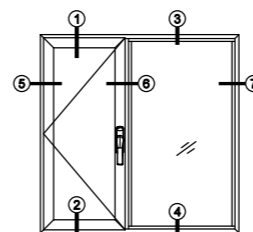

坚美系统75系列 外平开窗

75-CASEMENT WINDOW

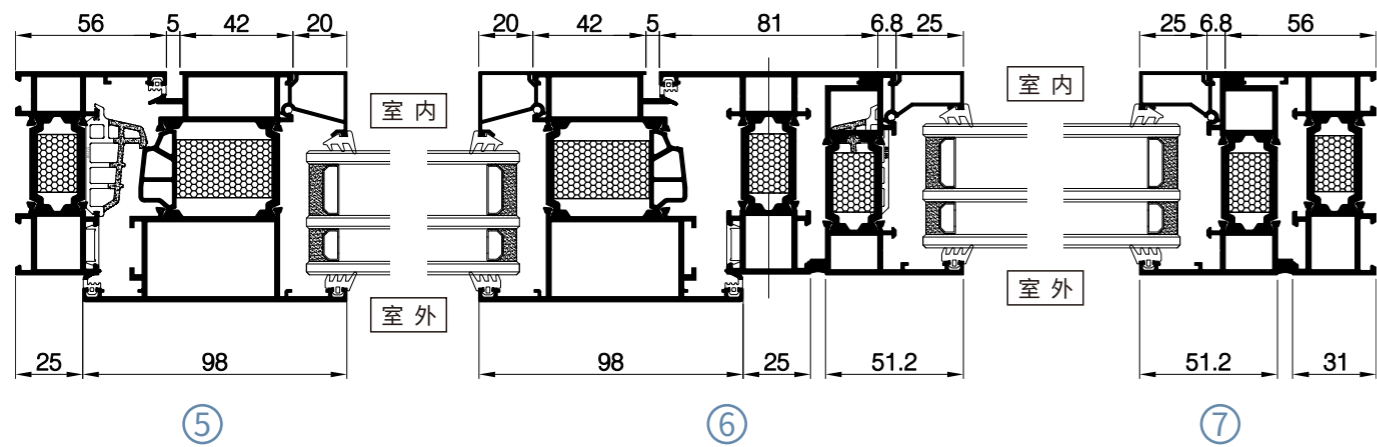
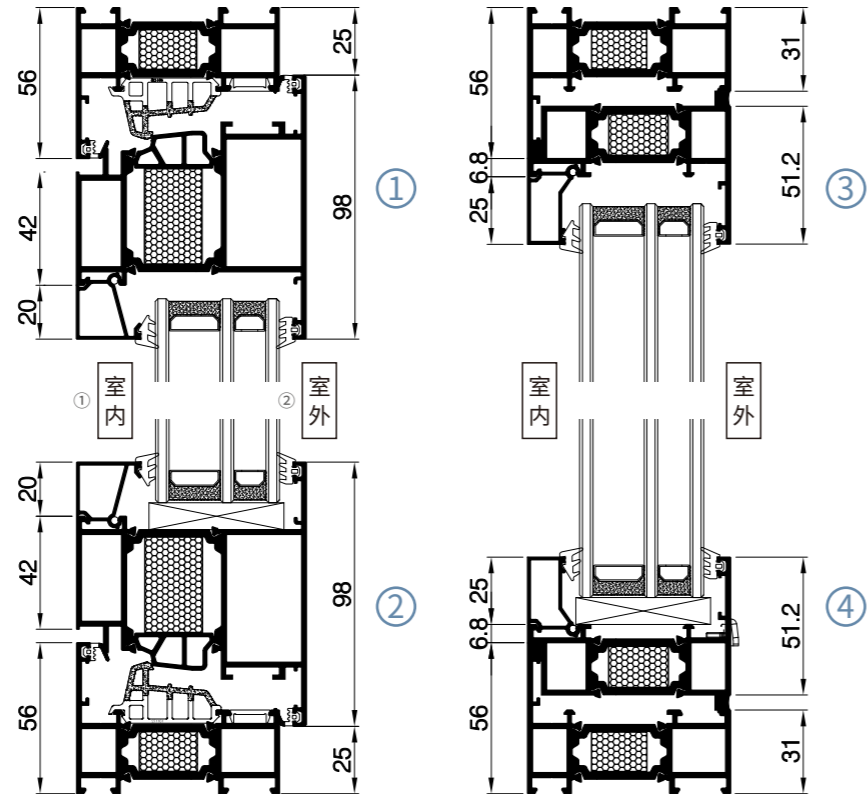
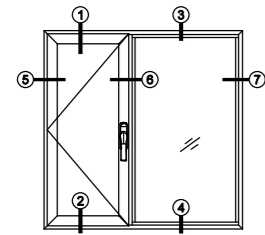

坚美系统80系列 外平开窗

80-CASEMENT WINDOW

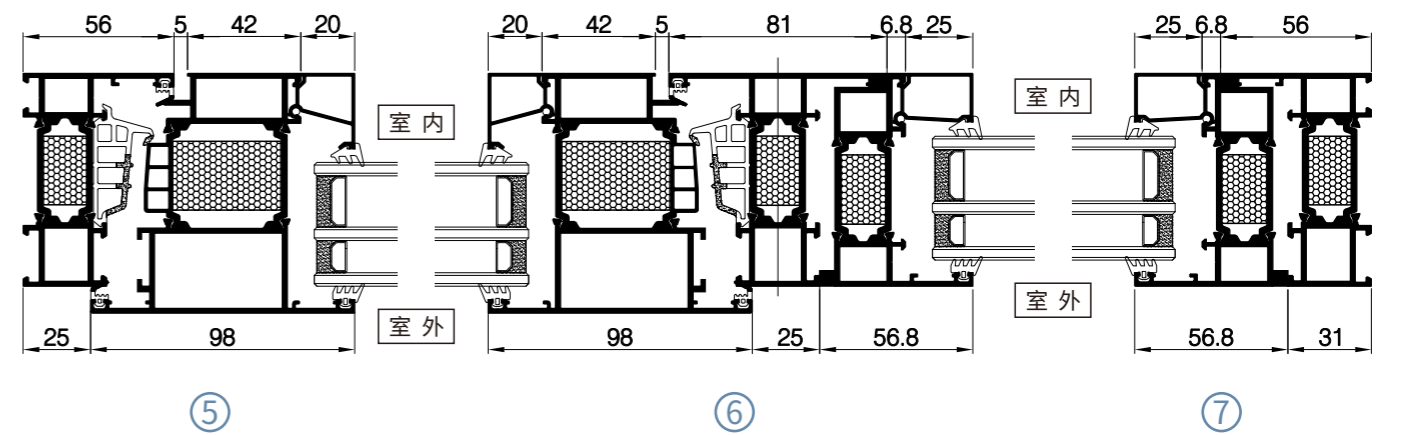
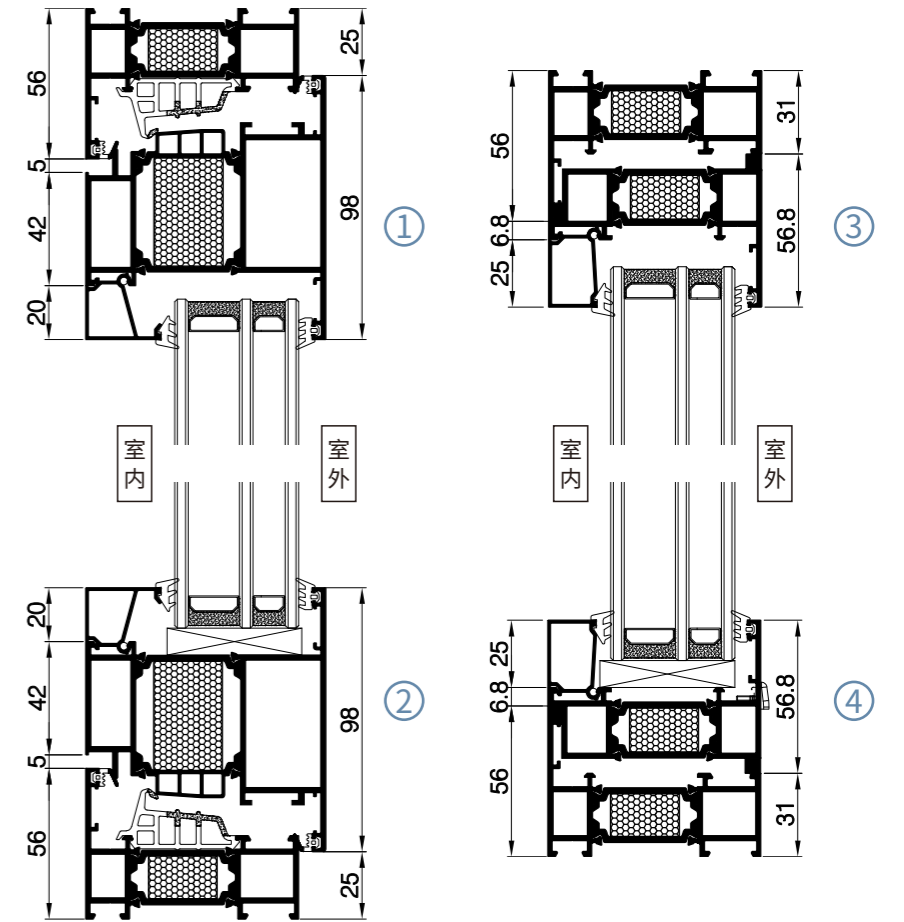
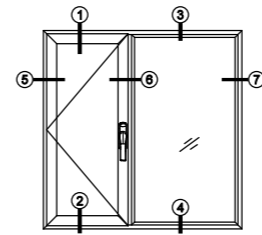

坚美系统95系列 外平开窗 95-CASEMENT WINDOW

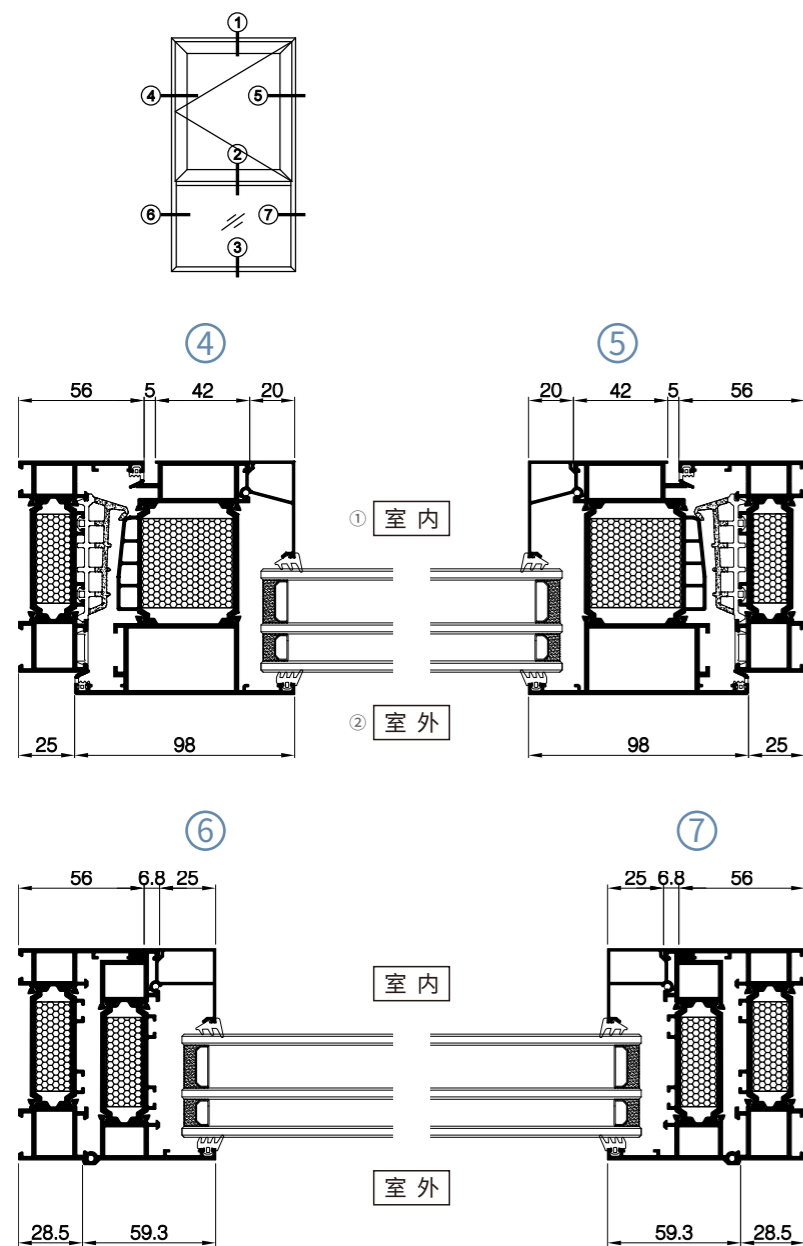

坚美系统105系列 外平开窗 105-CASEMENT WINDOW

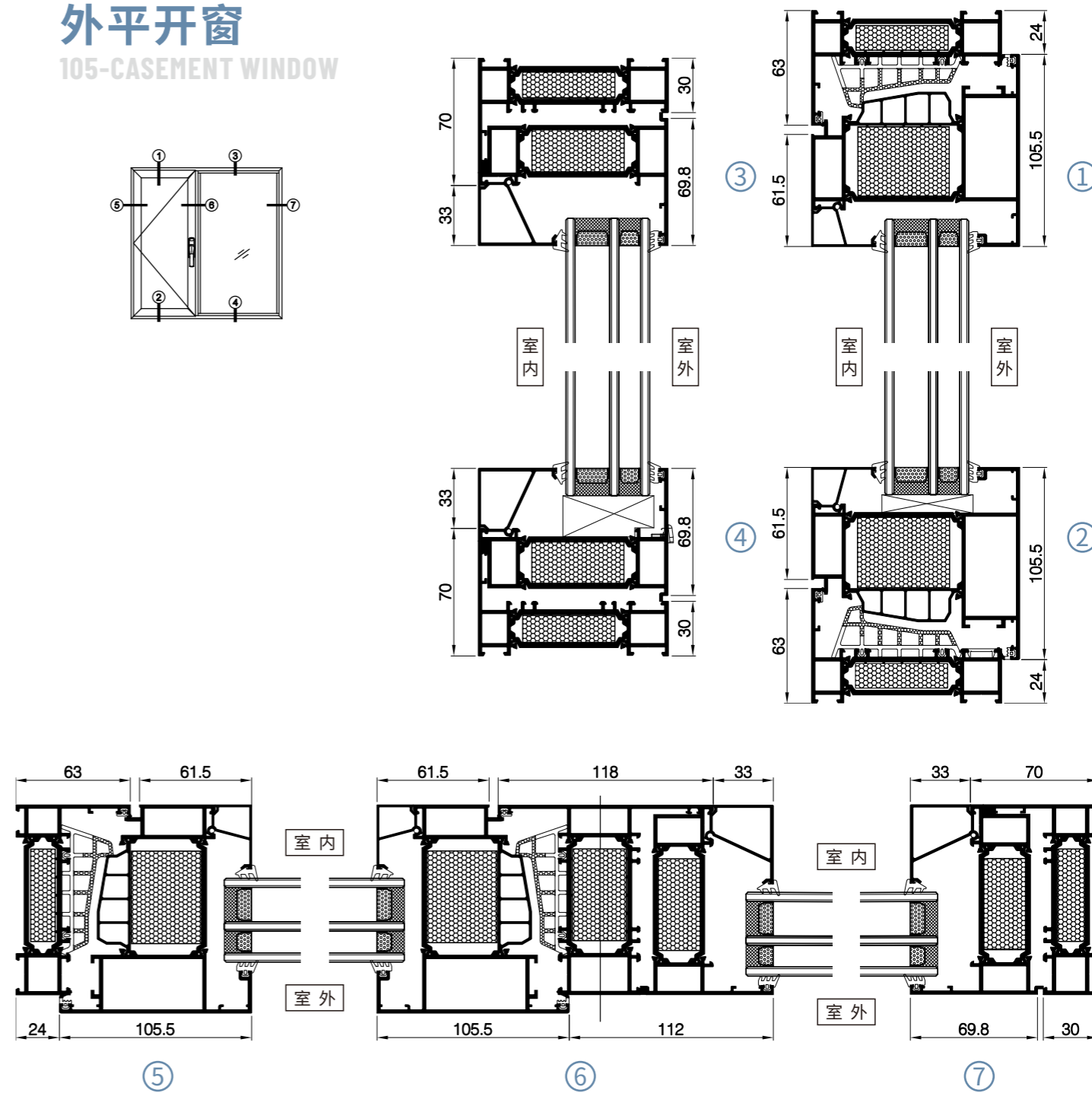
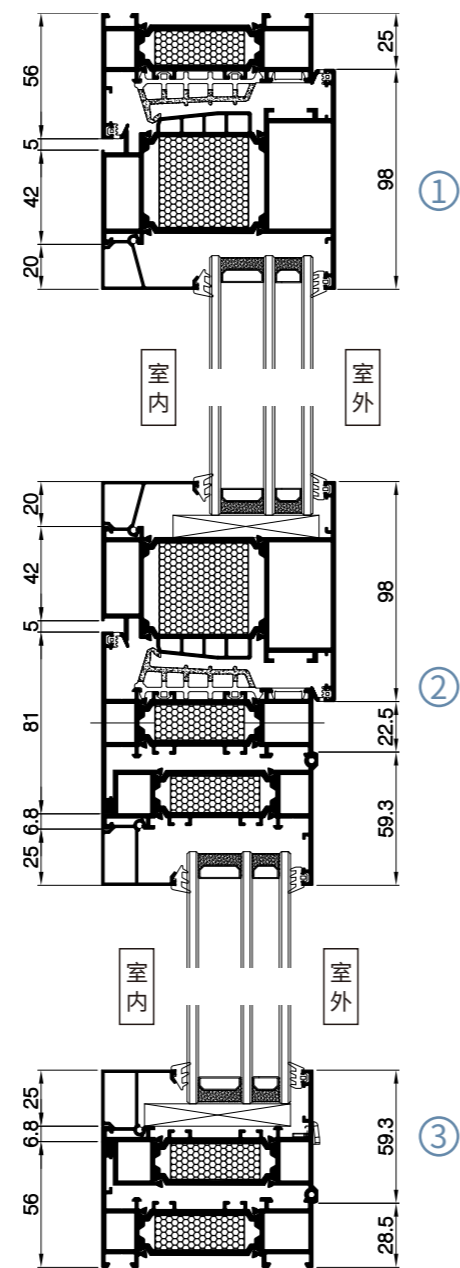



坚美系统70系列 内平开窗

70-TILT-AND-TURN WINDOW

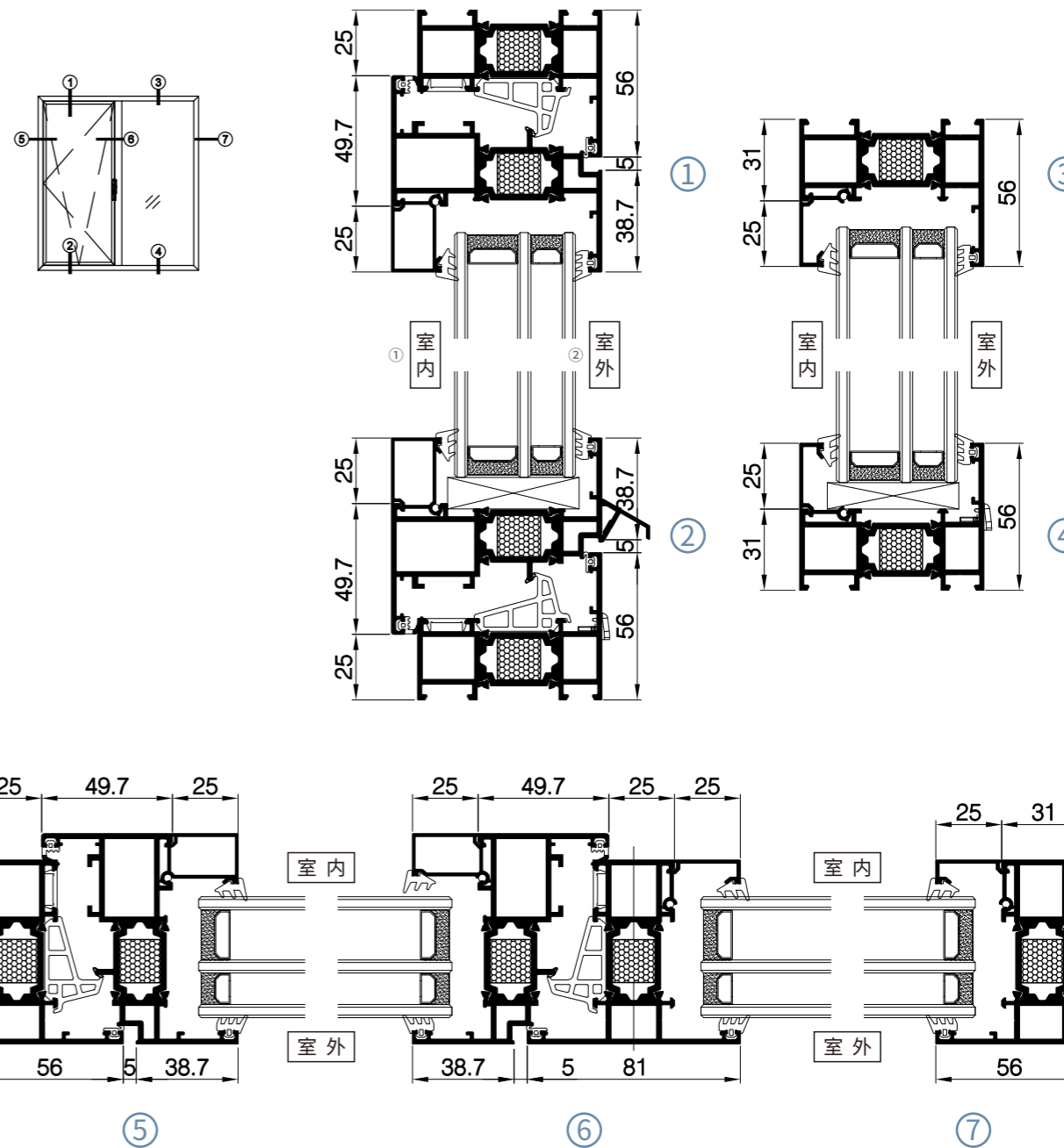

坚美系统75系列 内平开窗

75-TILT-AND-TURN WINDOW

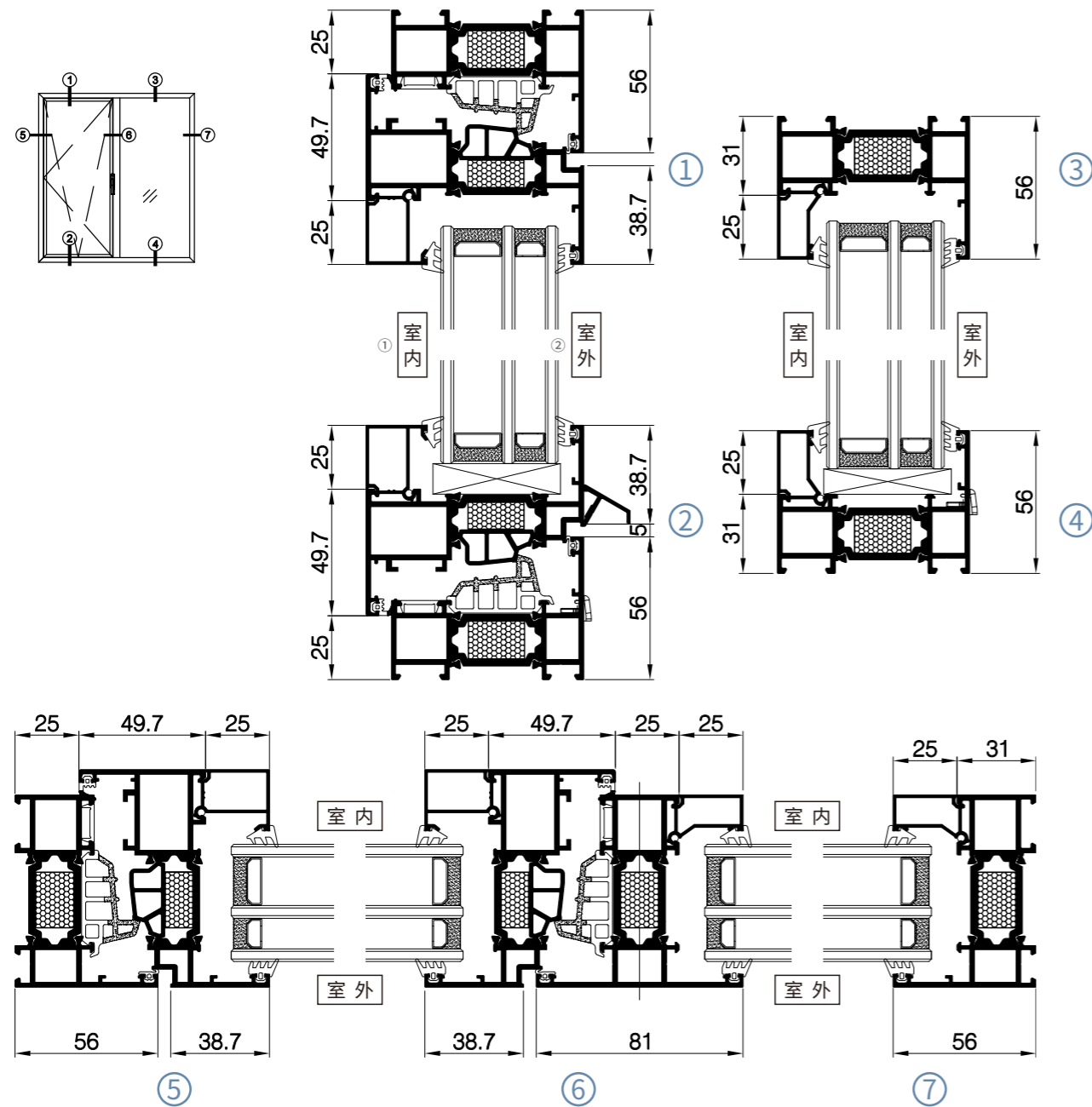

坚美系统80系列 内平开窗

80-TILT-AND-TURN WINDOW

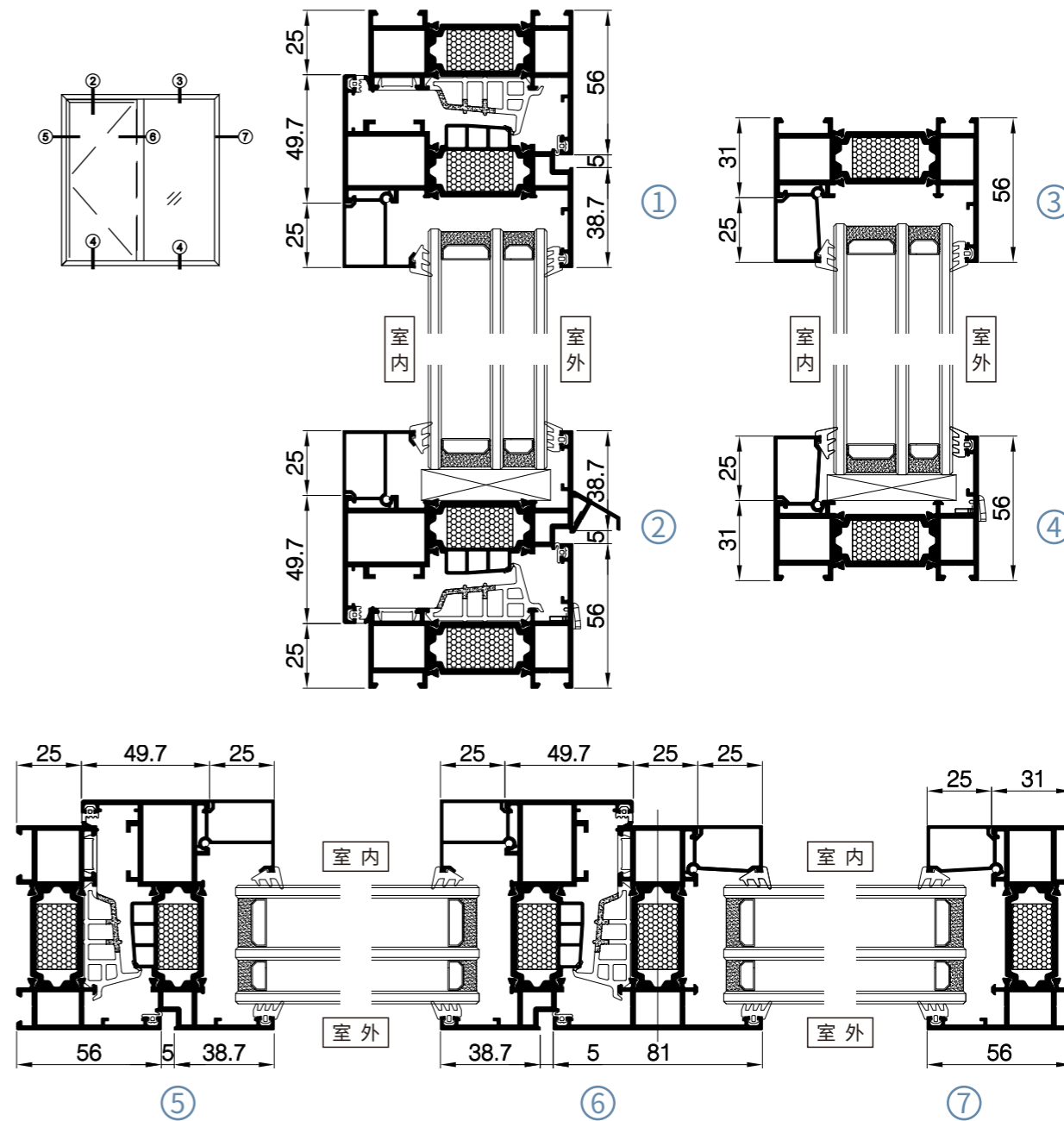

坚美系统95系列 内平开窗 95-TILT-AND-TURN WINDOW

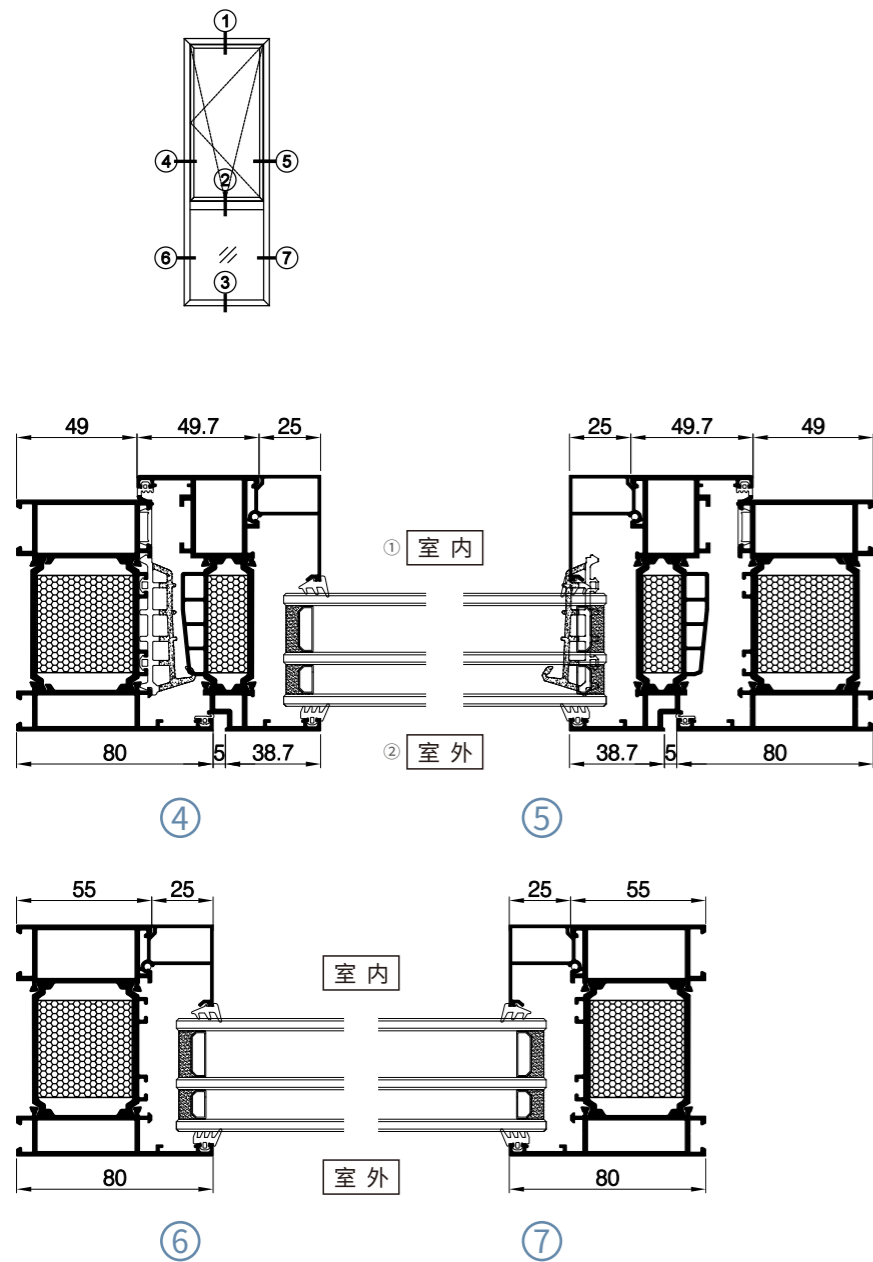

坚美系统105系列 内平开窗 105-TILT-AND-TURN WINDOW

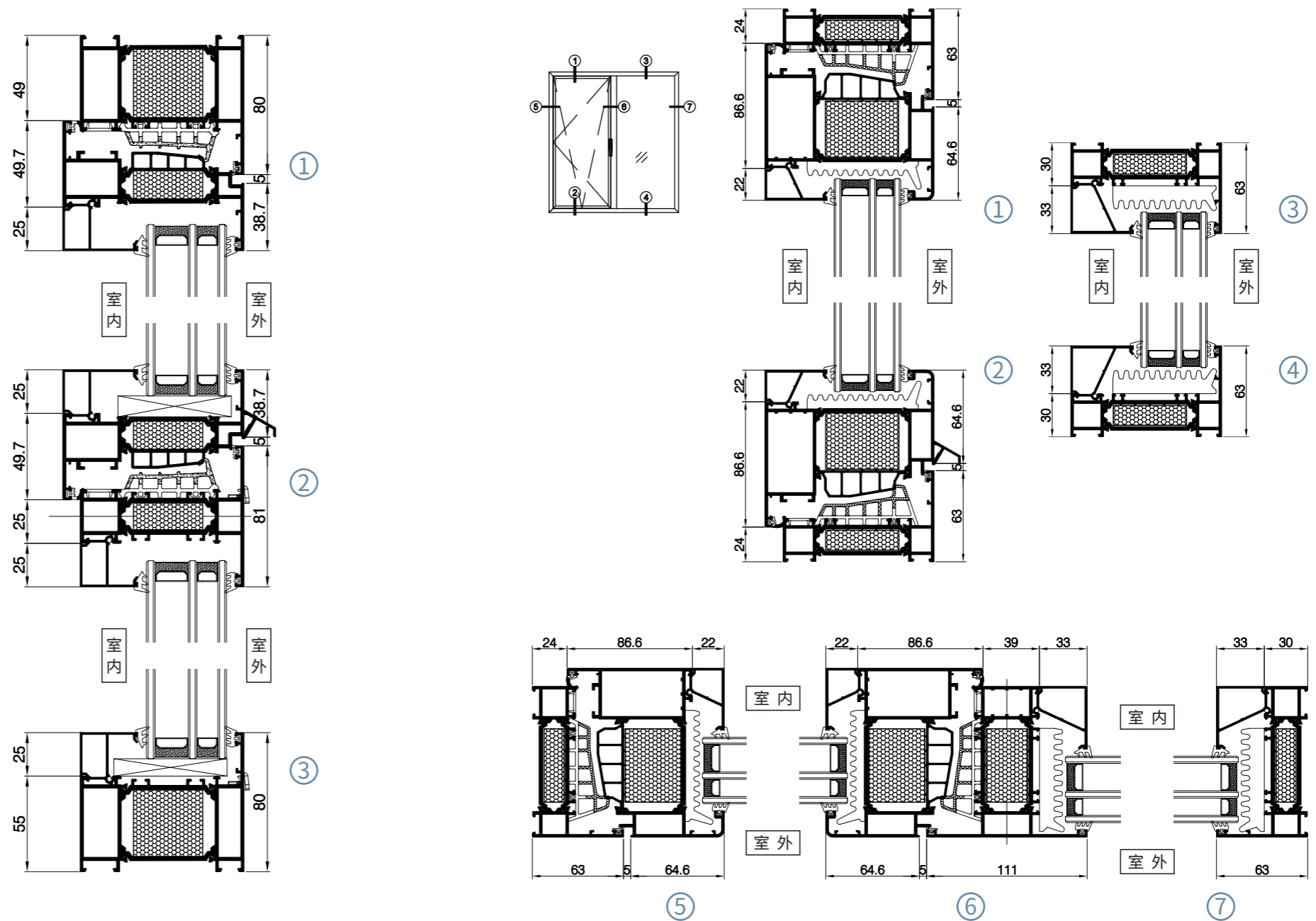

坚美系统70系列 外平开门 70-HINGED DOOR

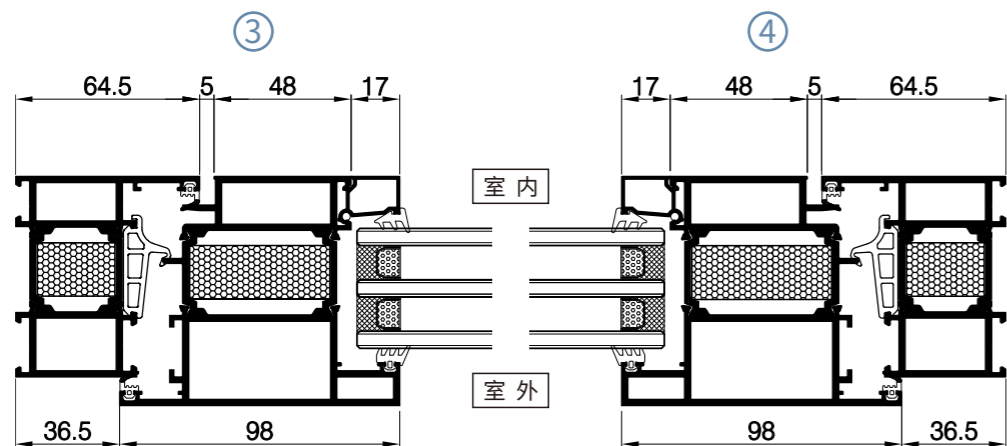
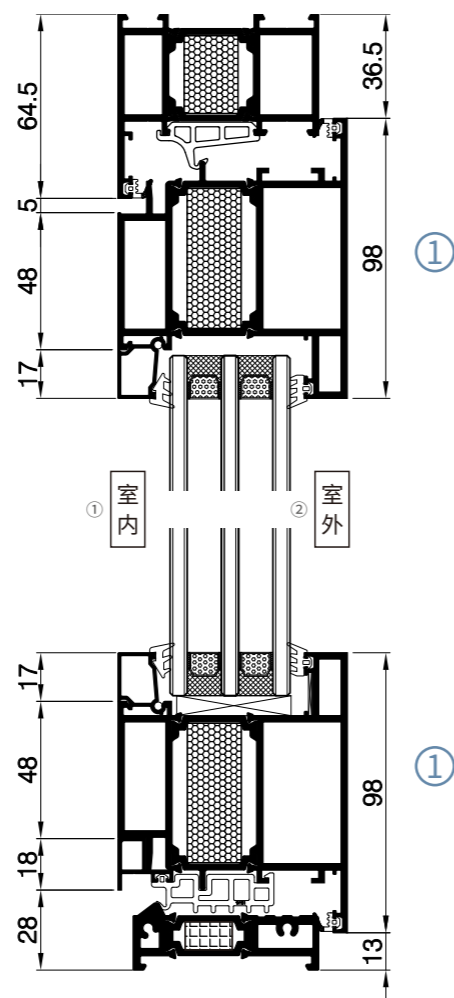
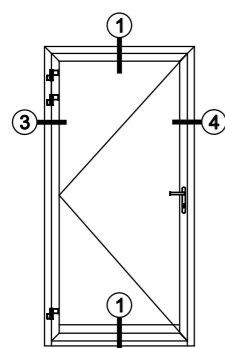

坚美系统75系列 外平开门 75-HINGED DOOR

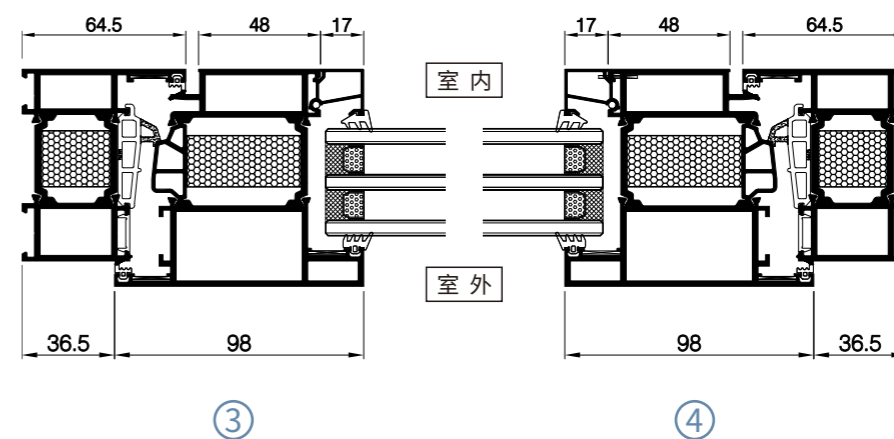
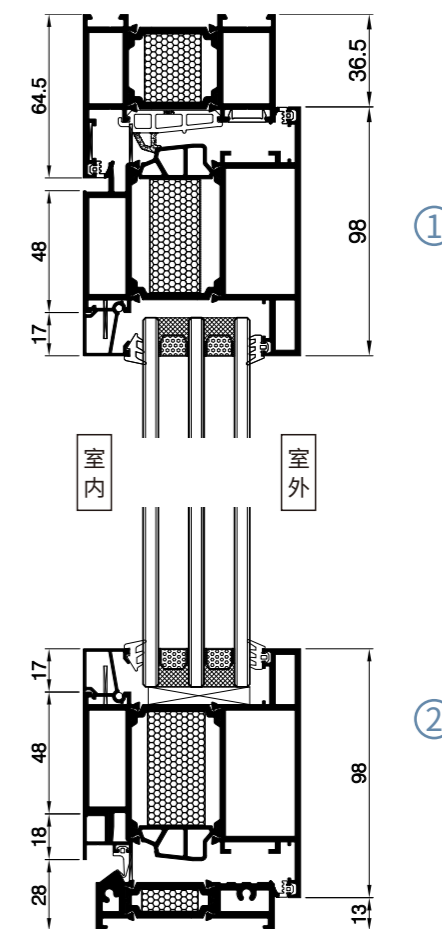
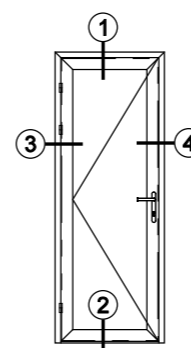

坚美系统80系列 外平开门 80-HINGED DOOR

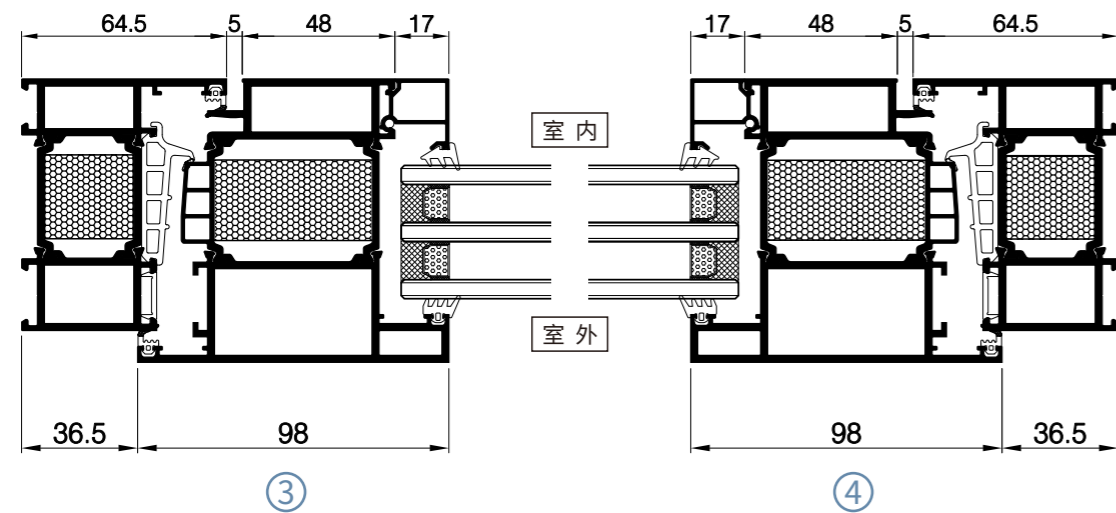
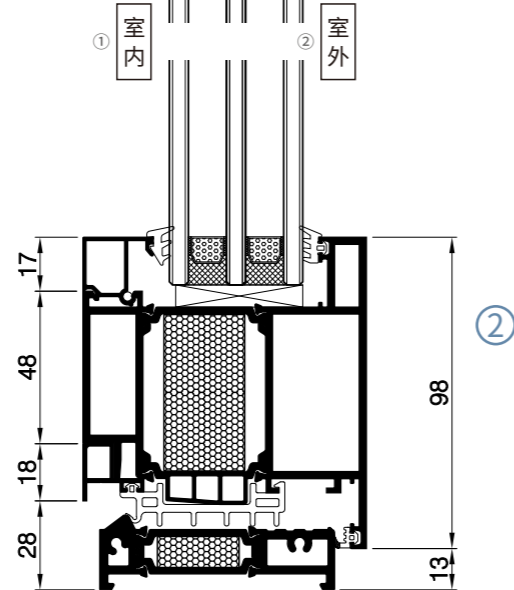
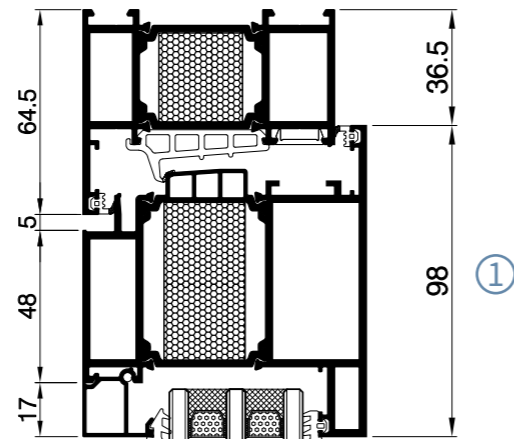
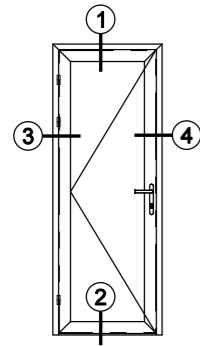

坚美系统105系列 外平开门 105-HINGED DOOR

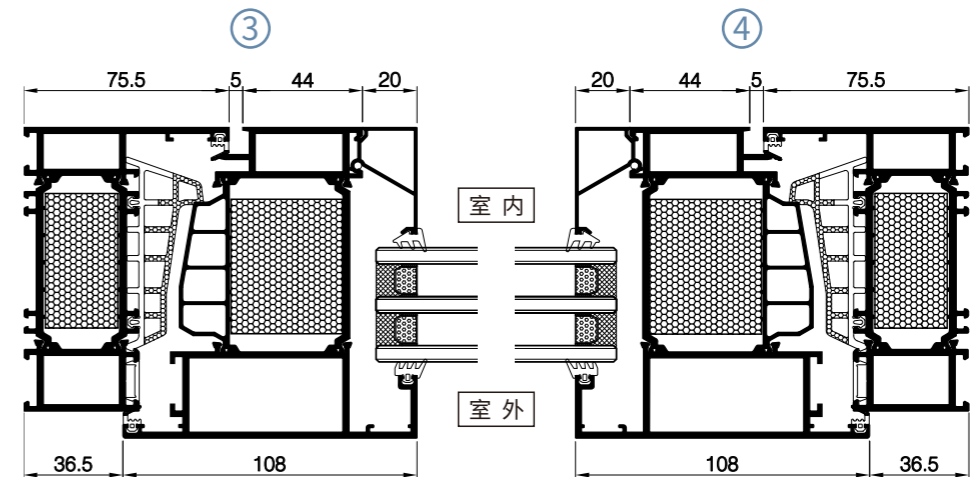
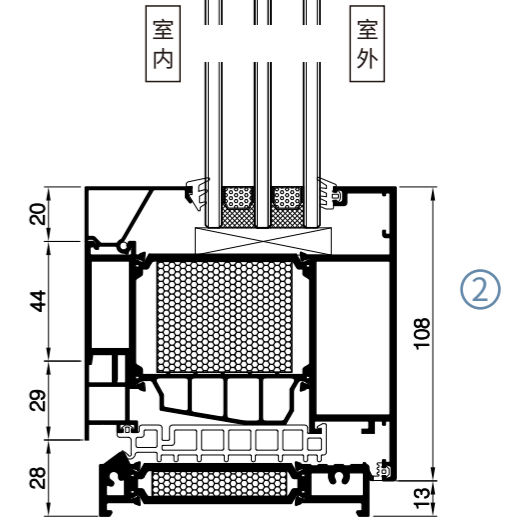
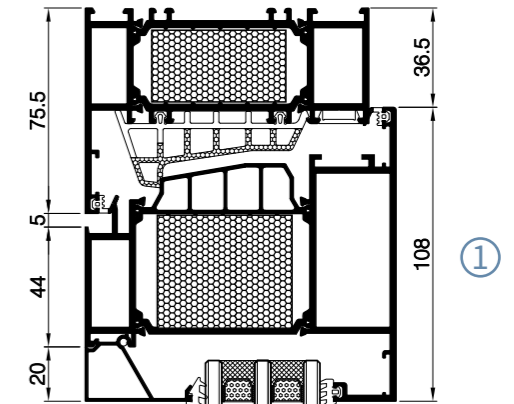
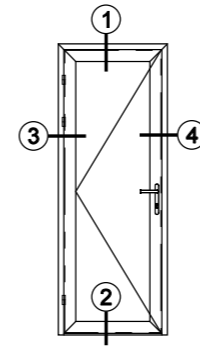



坚美系统100系列 推拉窗 100-SLIDING WINDOW

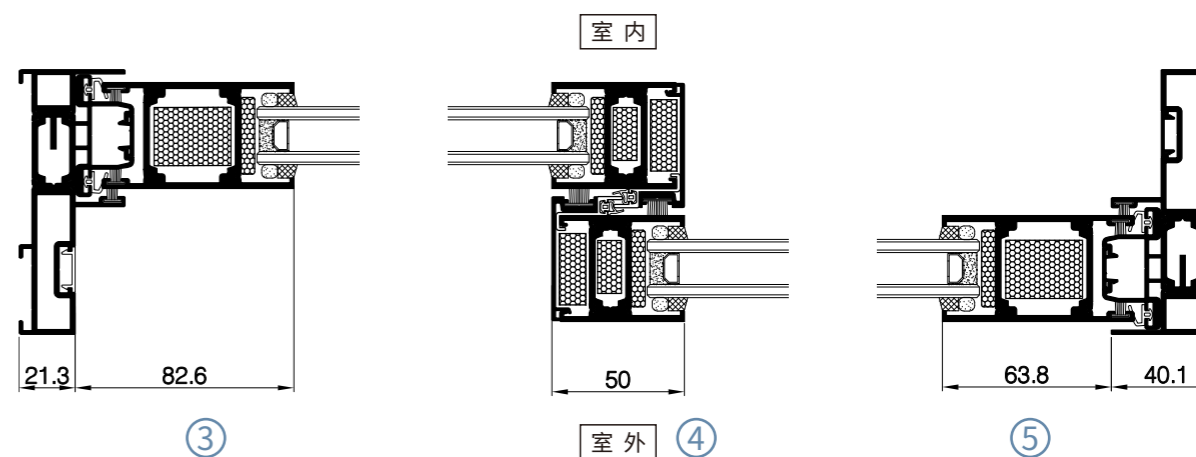
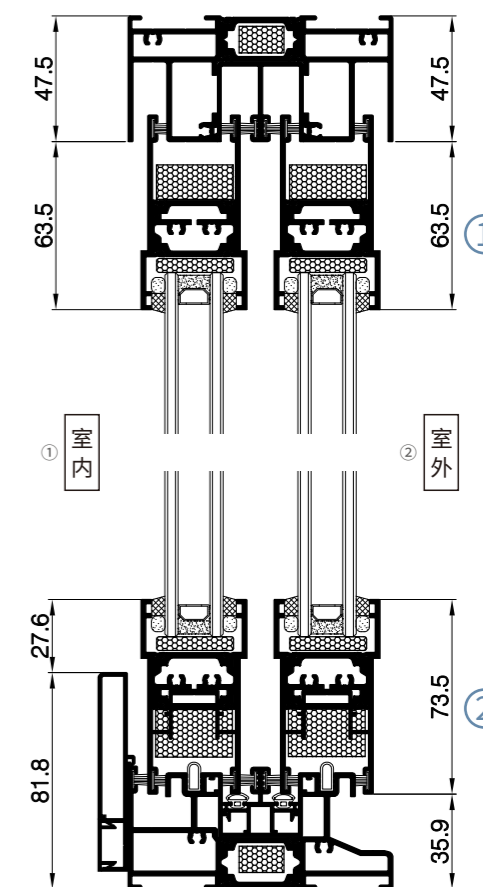
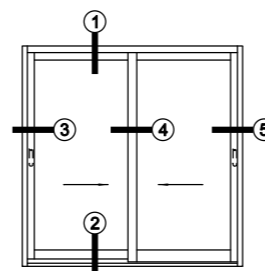

坚美系统100系列
推拉窗
100-SLIDING WINDOW

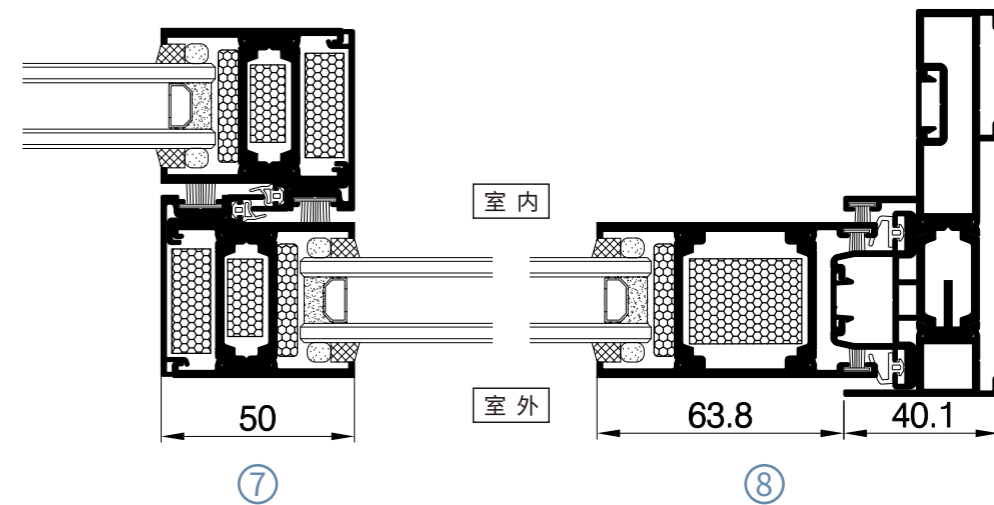
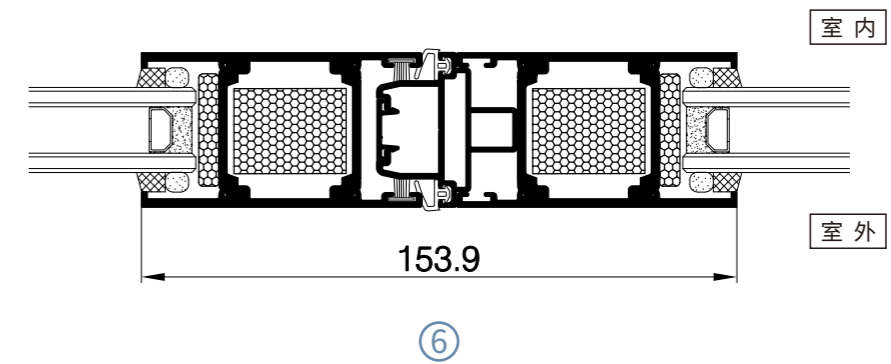
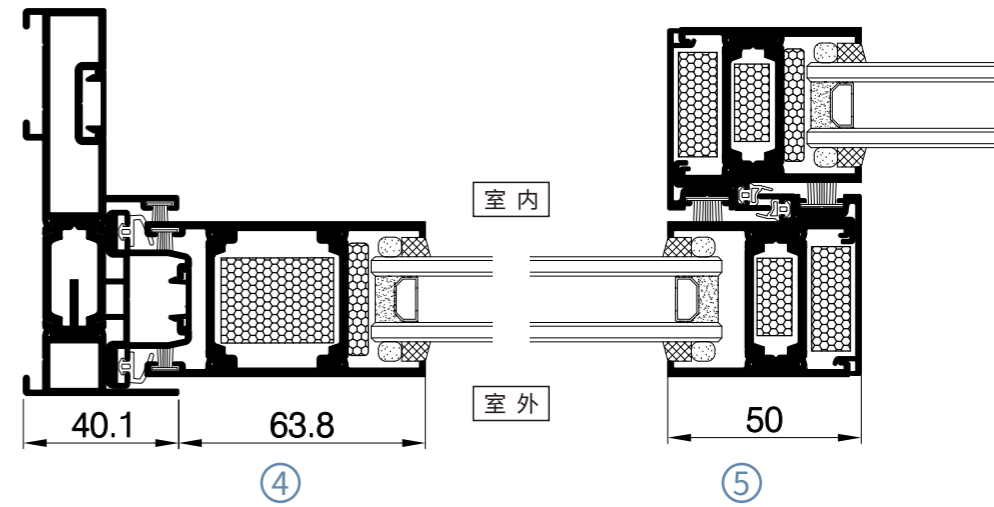
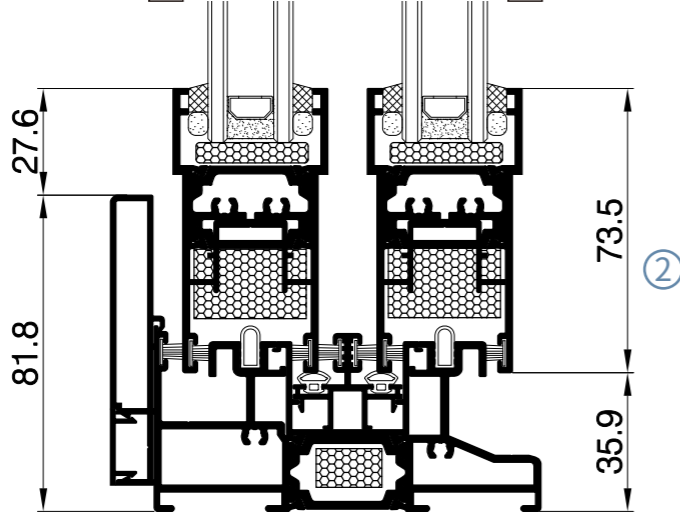
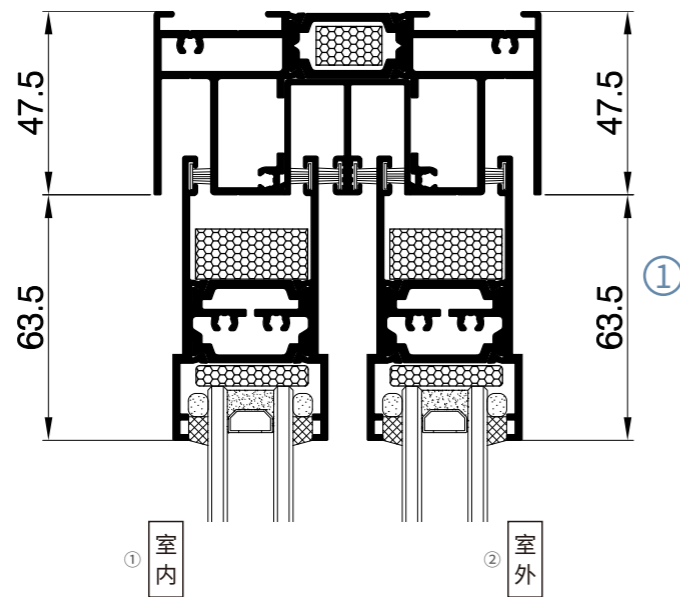
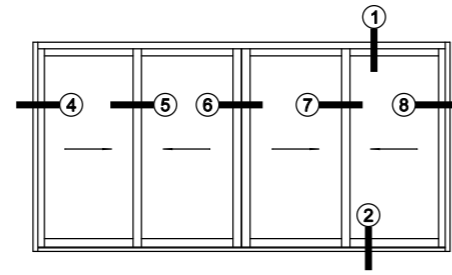

坚美系统150系列 推拉门 150-SLIDING DOOR

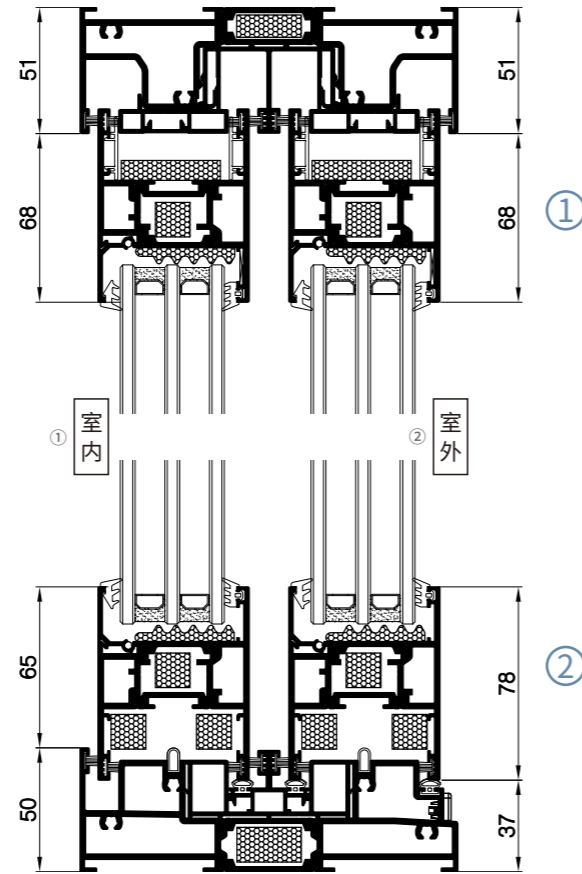
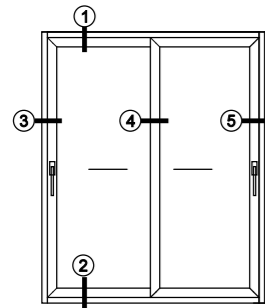

坚美系统170系列 推拉门 170-SLIDING DOOR

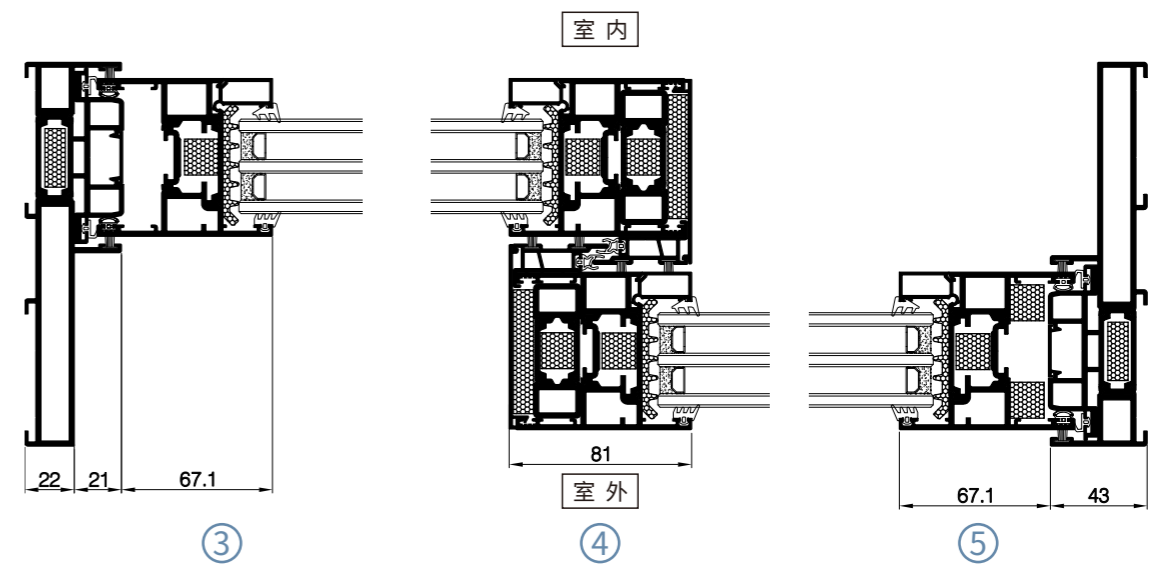
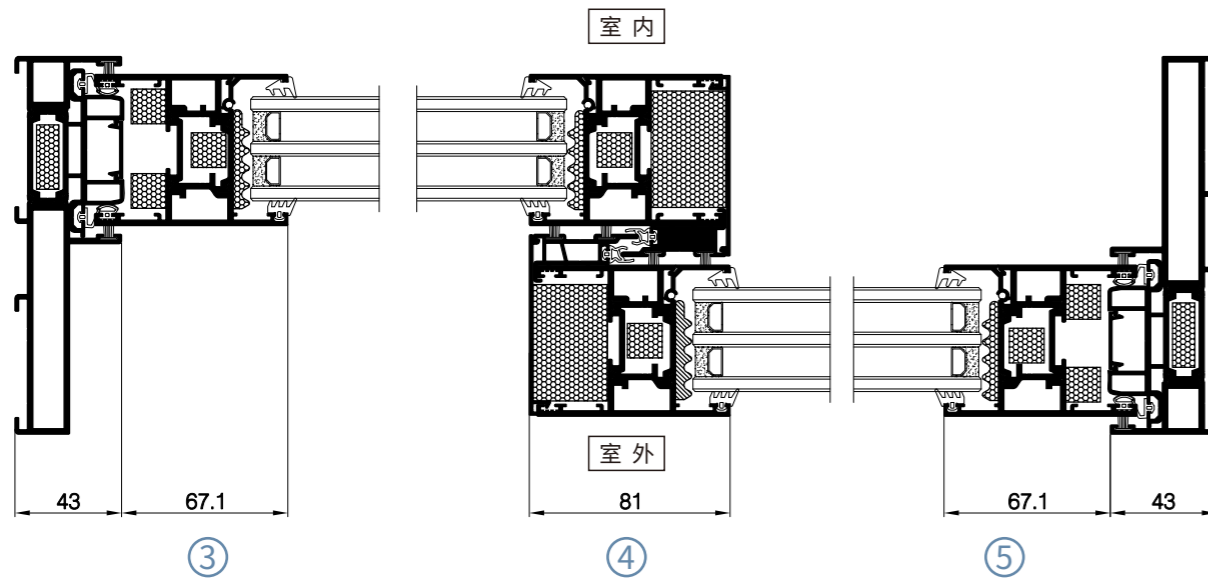
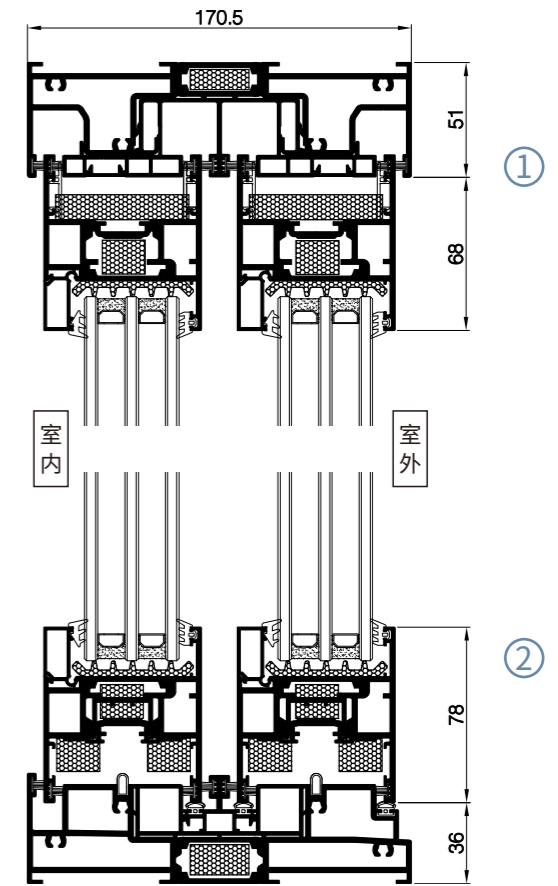
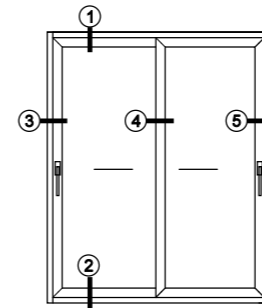

坚美系统150系列
推拉门
150-SLIDING DOOR

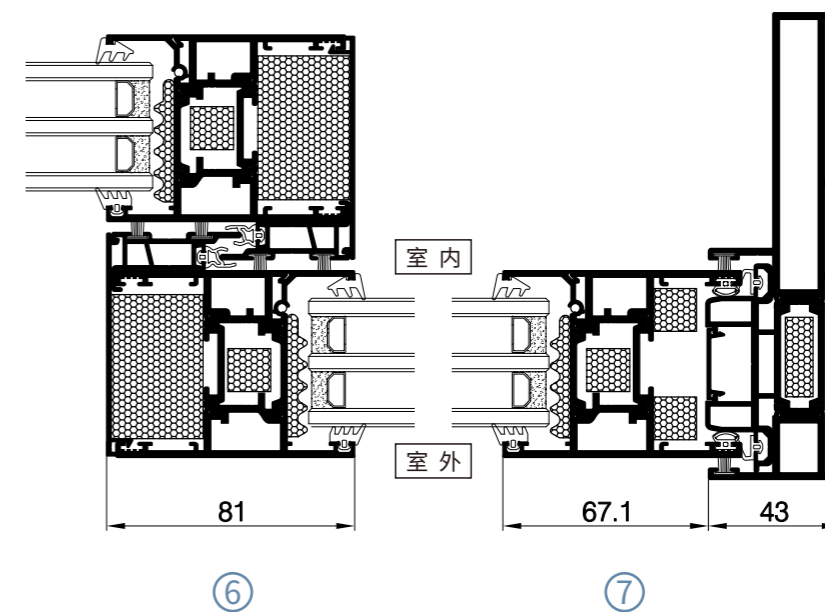
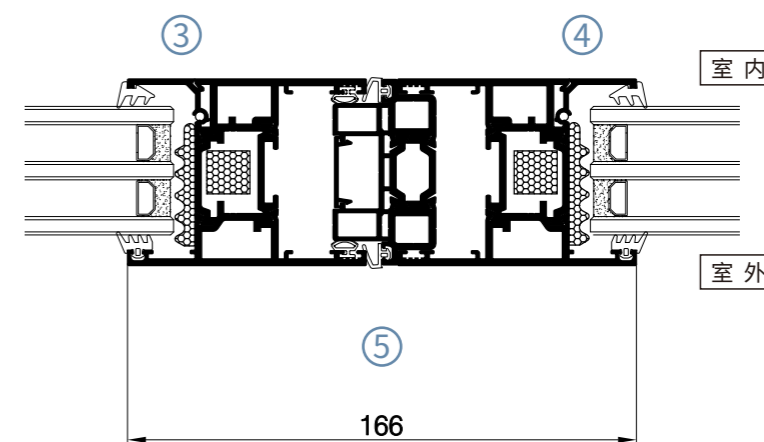
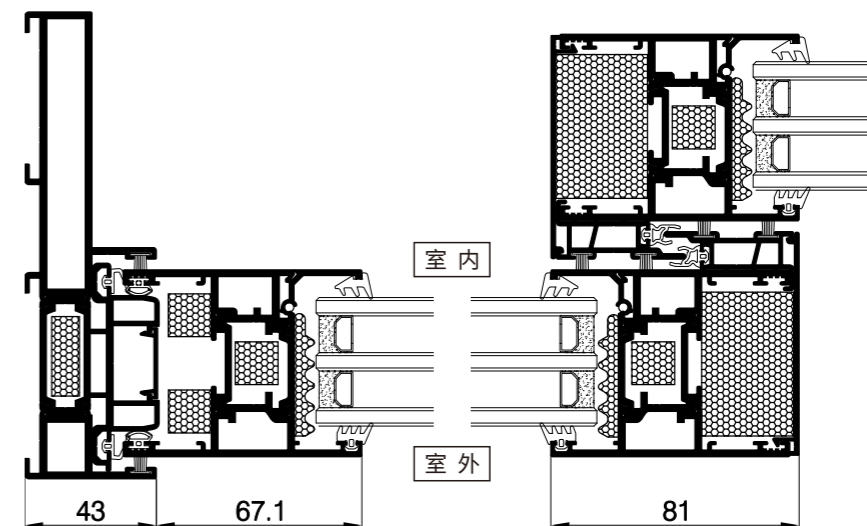
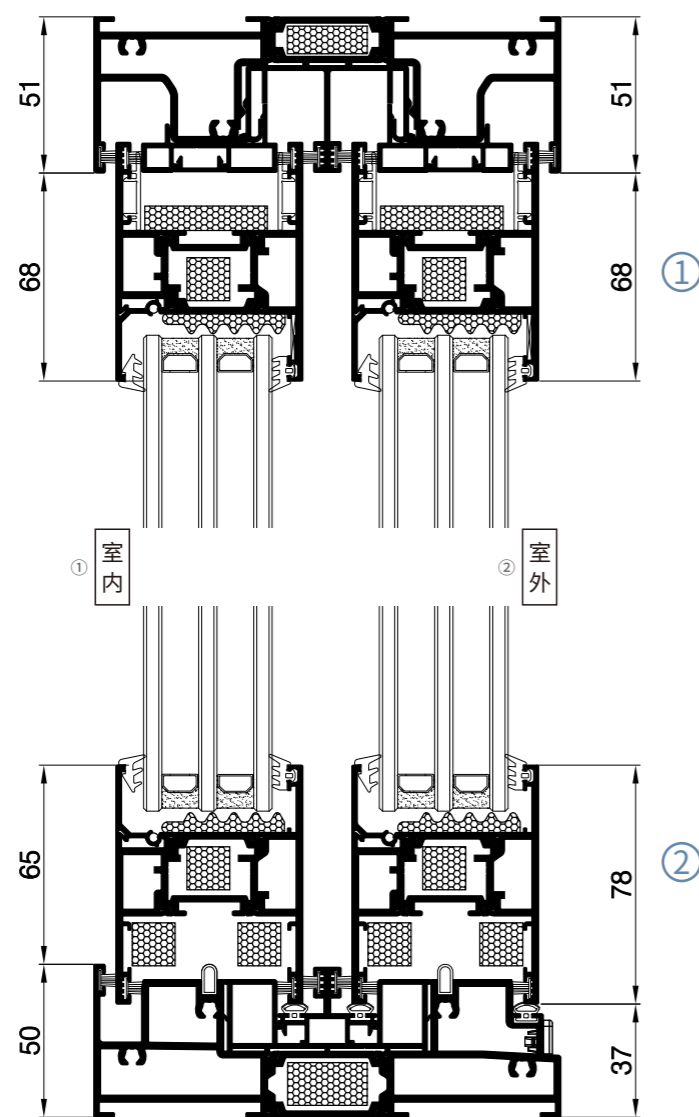
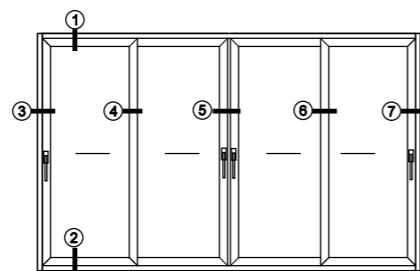

坚美系统170系列
推拉门
170-SLIDING DOOR

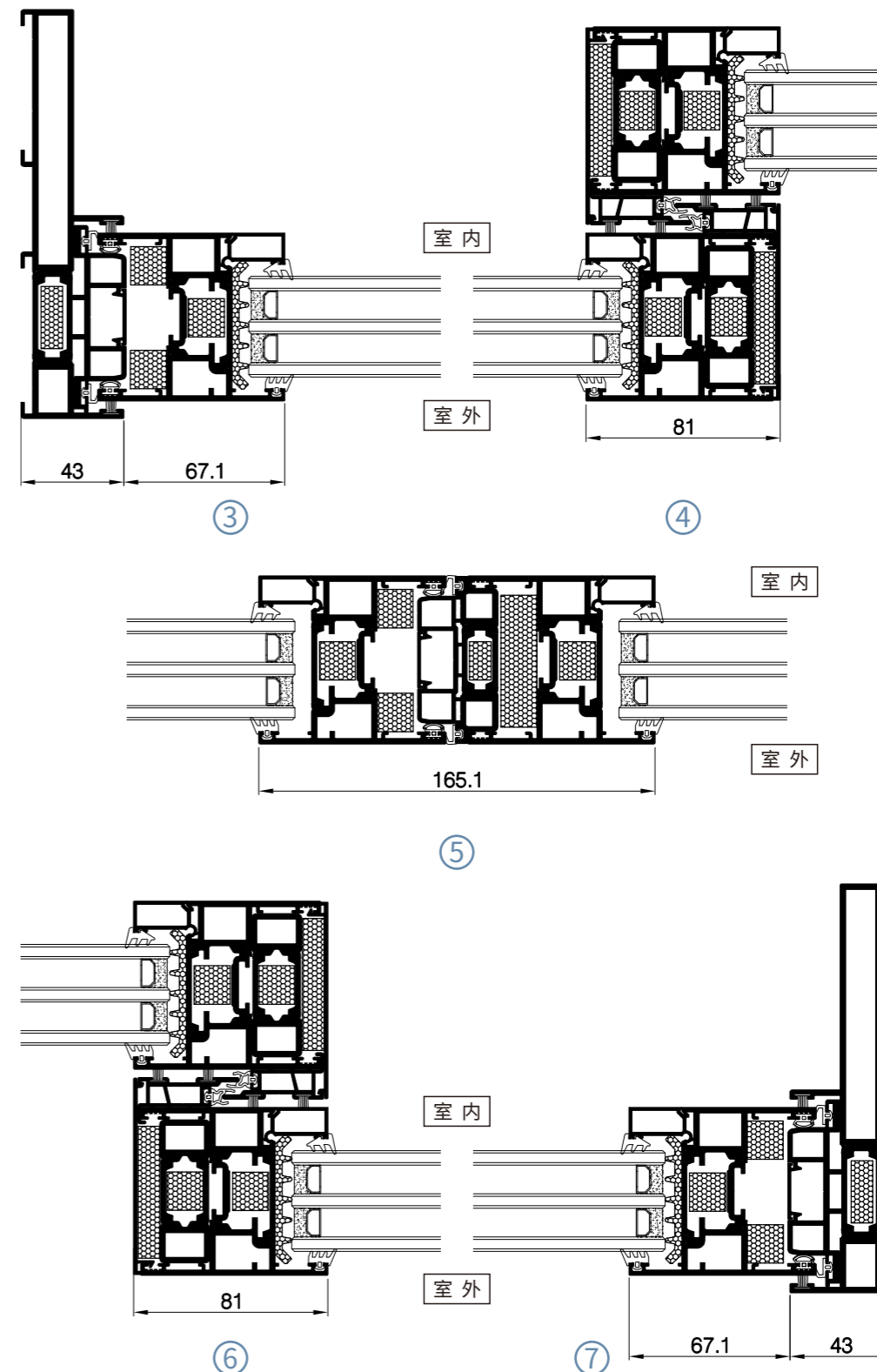
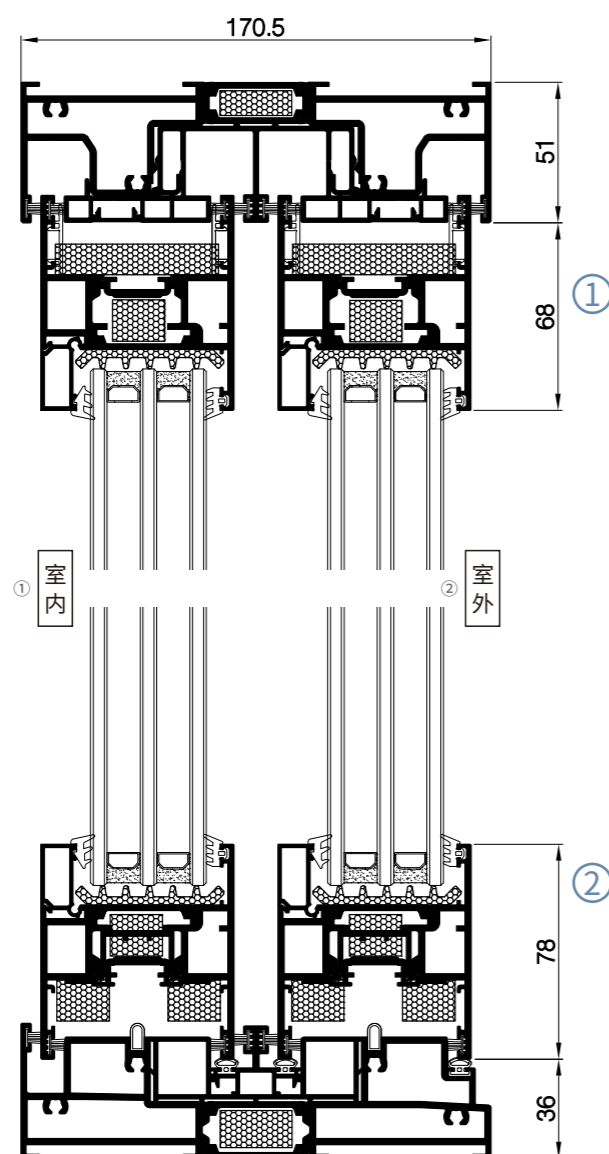
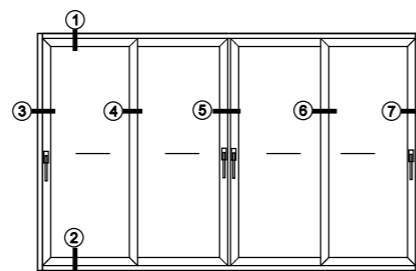

坚美系统150系列 提升推拉门 150-LIFT-AND-SLIDE DOOR

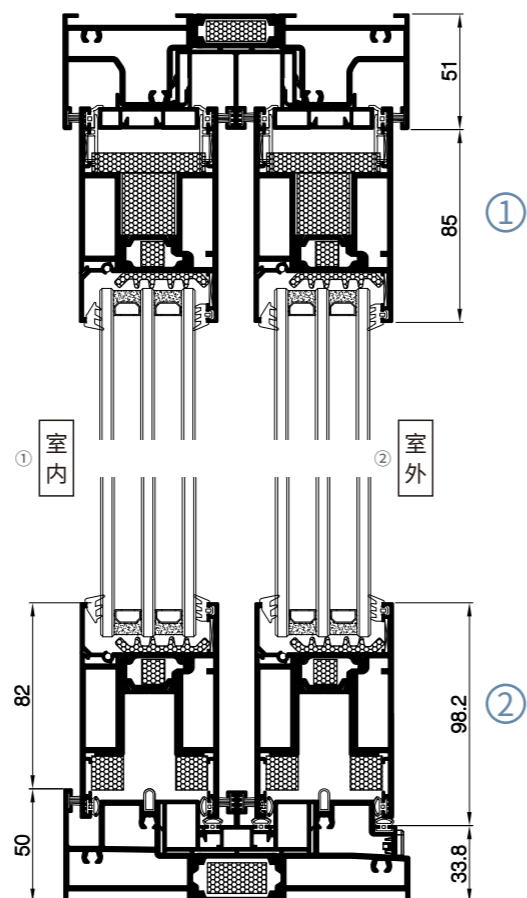
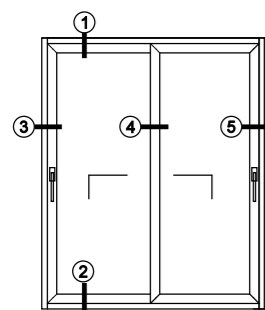

坚美系统170系列 提升推拉门 170-LIFT-AND-SLIDE DOOR

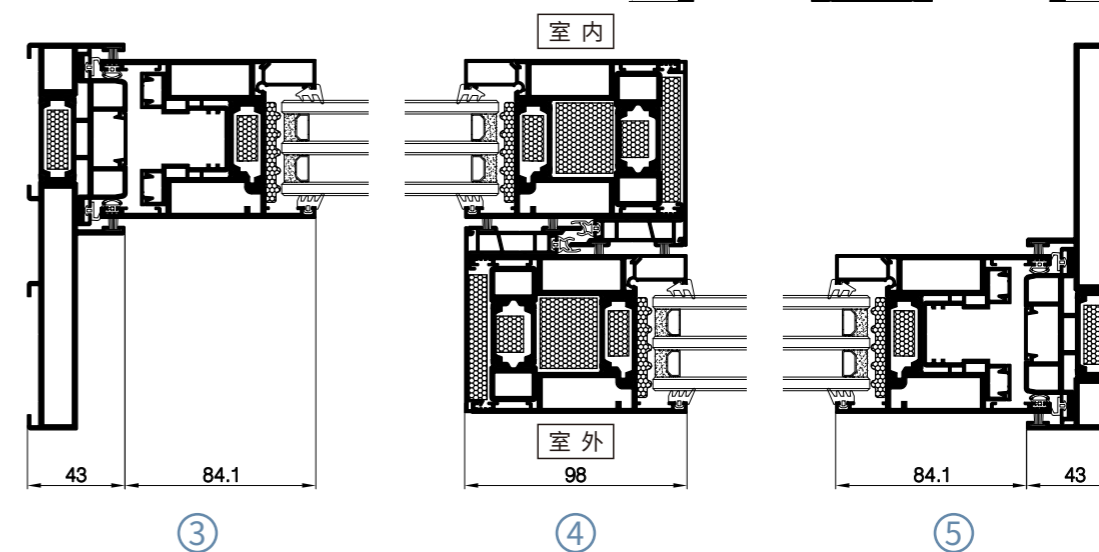
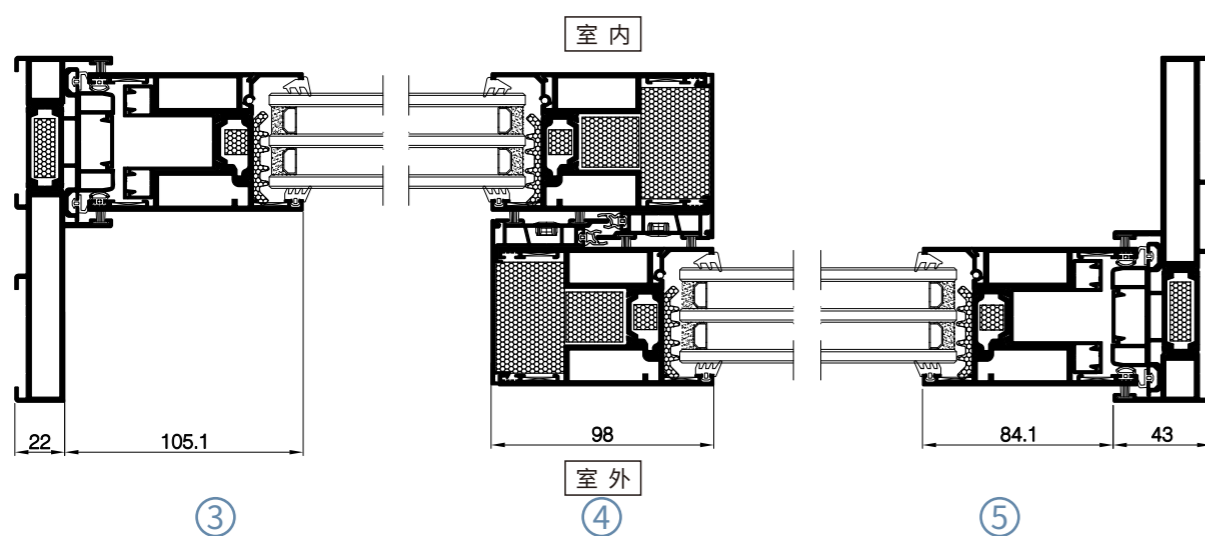
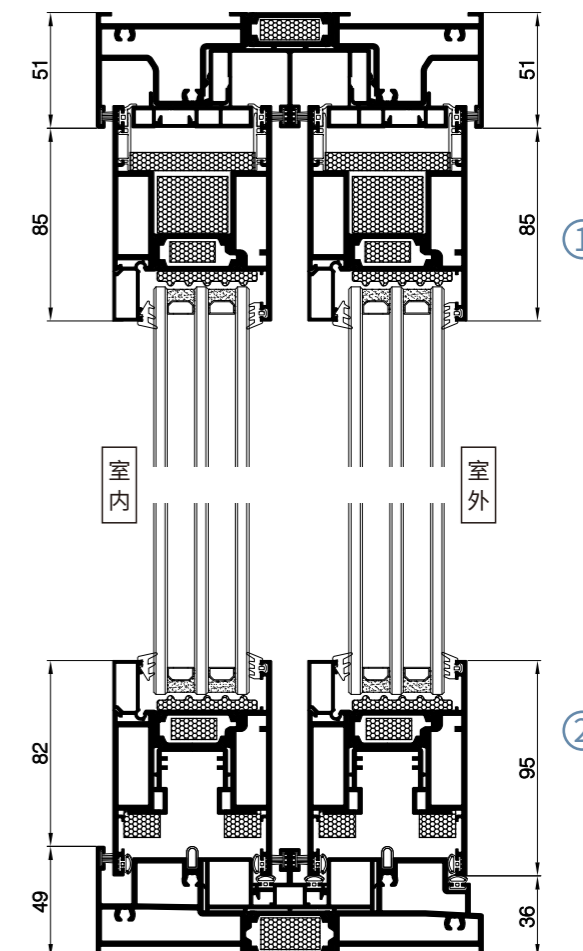
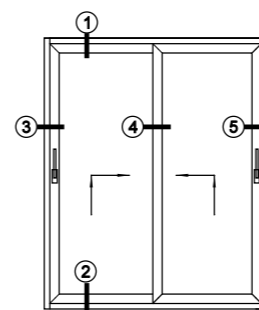

坚美系统150系列
提升推拉门
150-LIFT-AND-SLIDE DOOR

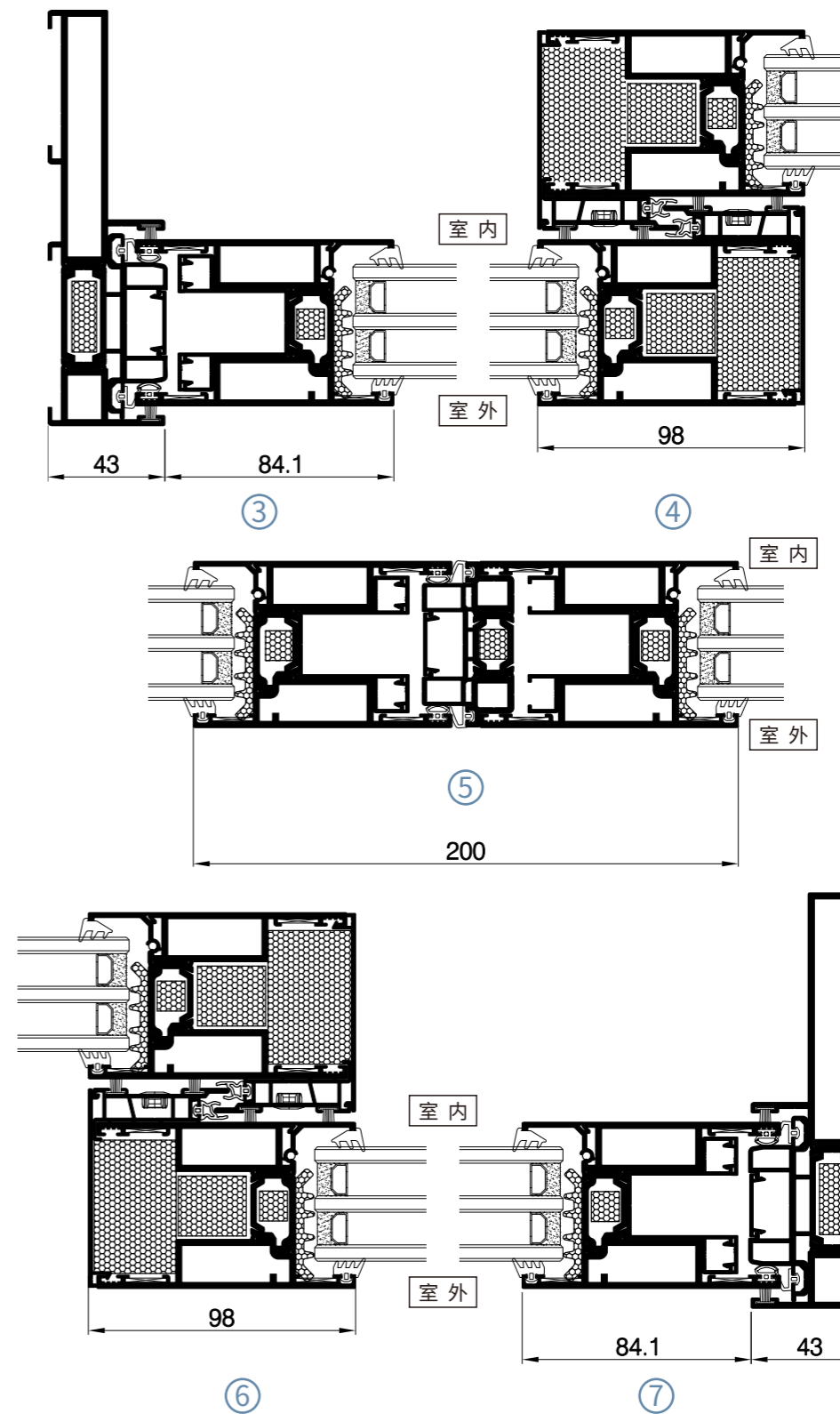
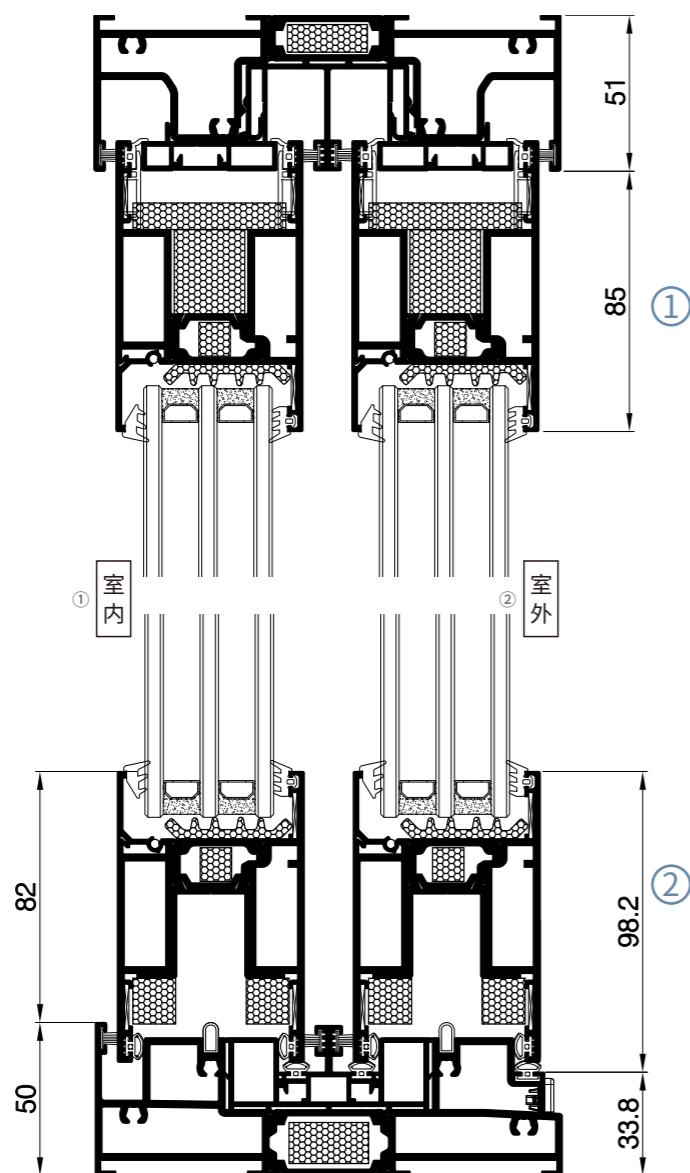
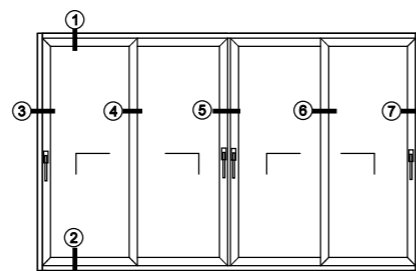

坚美系统170系列
提升推拉门
170-LIFT-AND-SLIDE DOOR

