



坚持追求完美

Insisting on Pursuing Perfection

幕墙型材系列Curtain wall series

Guangdong Jma Aluminium Profile Factory Co., Ltd. is a comprehensive large size enterprise integrating research, design, production and sales of aluminium alloy profiles for building and industrial applications as well as windows, doors and curtain walls. The powerful comprehensive technology.

Catalogue 2022

普通系列

JM110A半隐框(隐框)幕墙	001-008
JMCW100/120系列隐框幕墙	009-010
JMCW120/145/165系列幕墙	011-013
JMCW130系列明框幕墙	014-015
MQ130系列隐框幕墙	016-017
MQ135系列明框幕墙	018-019
JM138明(隐)框幕墙	020-025
JM140A明框幕墙	026-029
JM140C系列横明竖隐幕墙	030-031
JMCW140/150/190系列隐框幕墙	032-034
JMCW140/170系列明框幕墙	035-038
JMCW145系列隐框幕墙	039-041
MQ140系列幕墙	042-045
Y145系列隐框幕墙	046-047
JMCW150系列横明竖隐幕墙	048-050
JM150B隐框幕墙	051-052
JM150C明框幕墙	053-055
JM155明框幕墙	056-057
JMGR158系列明框幕墙	058-060
JM160B隐框幕墙	061-062
MQ160系列竖明横隐幕墙	063-067
MQ160A系列明框幕墙	068-071
JMCW160系列明(隐)框幕墙	072-075
MQ165系列隐框幕墙	076-077
JM170系列明框幕墙	078-082
JM170系列隐框幕墙	083-084
MQ170B系列竖明横隐幕墙	085-087
QX175隐框幕墙	088-090
MQ180A明框幕墙	091-095
JMCW180/200系列隐框幕墙	096-097
轻型幕墙	098-100

隔热系列

JMGR120系列隔热幕墙	101-102
JMGR126/156/176系列明框幕墙	103-104
JMGR140系列隔热幕墙	105-108
JMGR140/220系列明框幕墙	109-110
JMLY145系列隔热幕墙	111-113
JMGR155系列隔热幕墙	114-118
JMCW120系列隔热幕墙	119-121
JMCW140系列隔热幕墙	122-125
JMGR140A系列隔热幕墙(压入式隔热条)	126-130
JMGR150系列明框幕墙	131-132
JMCW153系列明框幕墙	133-134
JMCW160系列隔热幕墙	135-136
JMGR160A系列隔热幕墙	137-141
JMGR160B系列隔热幕墙	142-143
JMGR160C系列隔热幕墙(压入式隔热条)	144-145
JMGR164系列明框幕墙	146-147
JMGR170A系列明框幕墙	148-149
JMGR170B系列明框幕墙	150-151
JMCW180系列隔热幕墙	152-153
JMGR188系列明框幕墙	154-155
JMGR193系列明框幕墙	156-157
JMGR196/216系列明框幕墙	158-159
JMGR202系列明框幕墙	160-161
JM100隔热系列阳光房	162-163
JMGP100普通采光顶(阳光房)系列	164-170
雨棚系列	171-172
单元板式全隐框幕墙	173-174
单元板式竖明横隐幕墙	175-176
玻璃压块玻璃附框	177-186
挂件系列	187-190

General Series

Invisible and mid-invisible frame series JM110A	001-008
Invisible frame series JMCW100/120	009-010
Visible and invisible frame series JMCW120/145/165	011-013
Visible frame series JMCW130	014-015
Invisible frame series MQ130	016-017
Visible frame series MQ135	018-019
Visible and invisible frame series JM138	020-025
Visible frame series JM140A	026-029
Mid-invisible frame series JM140C	030-031
Invisible frame series JMCW140/150/190	032-034
Visible frame series JMCW140/170	035-038
Invisible frame series JMCW145	039-041
Invisible frame series MQ140	042-045
Invisible frame series Y145	046-047
Mid-invisible frame series JMCW150	048-050
Invisible frame series JM150B	051-052
Visible frame series JM150C	053-055
Visible frame series JM155	056-057
Visible frame series JMGR158	058-060
Invisible frame series JM160B	061-062
Mid-invisible frame series MQ160	063-067
Visible frame series MQ160A	068-071
Visible and invisible frame series JMCW160	072-075
Invisible frame series MQ165	076-077
Visible frame series JM170	078-082
Invisible frame series JM170	083-084
Mid-invisible frame series MQ170B	085-087
Invisible frame series QX175	088-090
Visible frame series MQ180A	091-095
Invisible frame series JMCW180/200	096-097
Light curtain walls	098-100

Thermal Break Series

Thermal Break frame series JMGR120	101-102
Visible frame series JMGR126/156/176	103-104
Thermal Break frame series JMGR140	105-108
Visible frame series JMGR140/220	109-110
Thermal Break frame series JMLY145	111-113
Thermal Break frame series JMGR155	114-118
Thermal Break frame series JMCW120	119-121
Thermal Break frame series JMCW140	122-125
Thermal break curtain wall of series JMGR140A	126-130
Visible frame series JMGR150	131-132
Visible frame series JMCW153	133-134
Thermal Break frame series JMCW160	135-136
Thermal break curtain wall of series JMGR160A	137-141
Thermal break curtain wall of series JMGR160B	142-143
Thermal break curtain wall of series JMGR160C	144-145
Visible frame series JMGR164	146-147
Visible frame series JMGR170A	148-149
Visible frame series JMGR170B	150-151
Thermal Break frame series JMCW180	152-153
Visible frame series JMGR188	154-155
Visible frame series JMGR193	156-157
Visible frame series JMGR196/216	158-159
Visible frame series JMGR202	160-161
Thermal break frame series JM100(Winter garden)	162-163
Series JMGP100(Winter garden)	164-170
Canopy series	171-172
Invisible frame, unitized curtainwall	173-174
Mid-invisible frame, unitized curtainwall	175-176
Glass bricketting	177-186
Stone bracket series	187-190

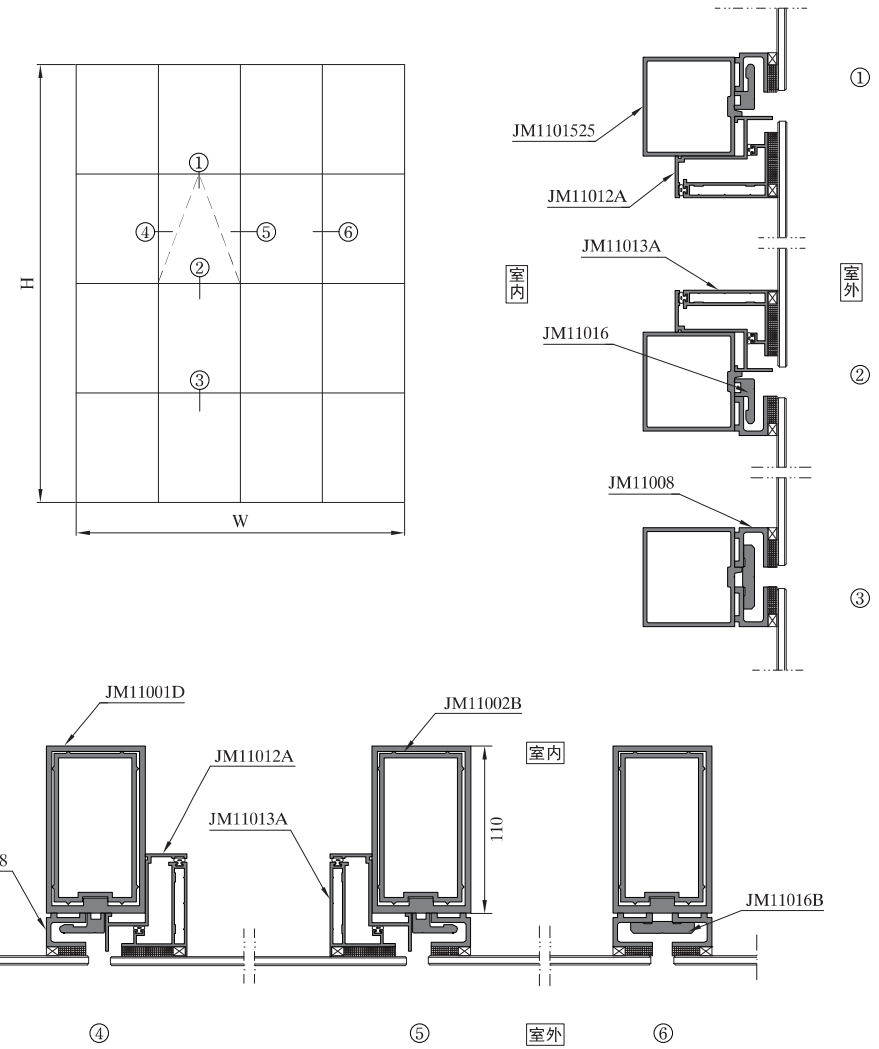



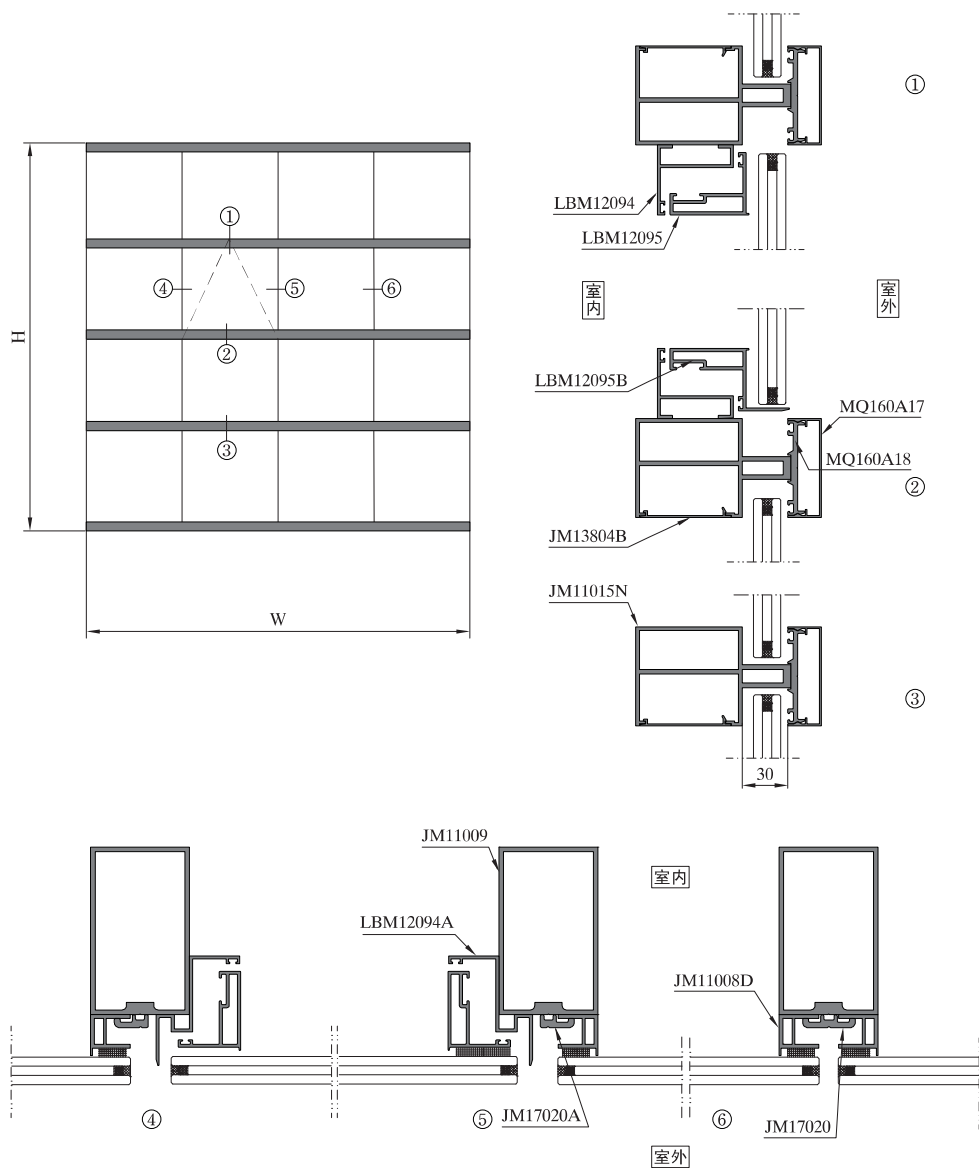

图中所示型材截面、装配、编号、尺寸及重量仅供参考。如有疑问，请向本公司查询。
 Information above just for your reference. Please contact us if you have any questions, Thank you!





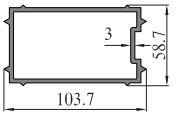
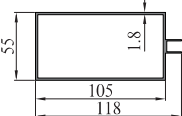
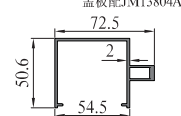
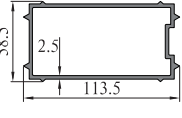
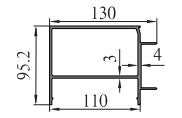
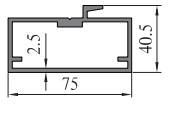
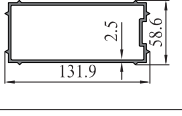
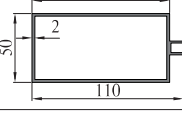
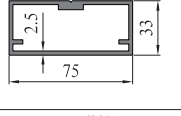
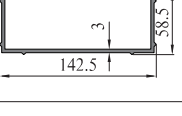
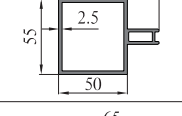
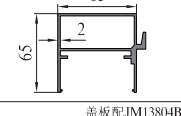
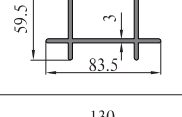
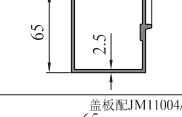
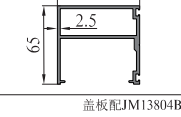
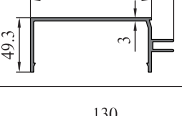
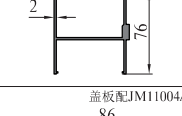
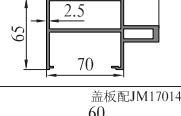

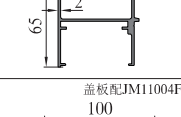
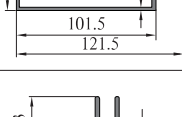
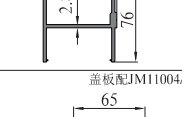
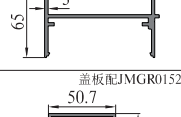
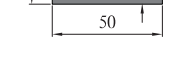
序号 S/N	型号理论重量 JMA Code & KG/M	型材图 Drawing	序号 S/N	型号理论重量 JMA Code & KG/M	型材图 Drawing	序号 S/N	型号理论重量 JMA Code & KG/M	型材图 Drawing
1	JM11001 4.243kg/m	套芯配JM11002	10	JM11001M 2.449kg/m	套芯配JM13802B	19	JM11009H 2.623kg/m	套芯配JM11002A
2	JM11001A 4.858kg/m	套芯配JM11002A	11	JM11001N 3.182kg/m	套芯配JM13802B	20	JM11009G 2.359kg/m	套芯配JM11002B
3	JM11001B 6.450kg/m	套芯配JM11002B	12	JM11001P 2.683kg/m	套芯配JM11002K	21	JM12009 3.392kg/m	套芯配JM12010A
4	JM11001C 5.443kg/m	套芯配JM11002C	13	JM11001S 2.546kg/m	套芯配JM11002D	22	JM14009 4.008kg/m	套芯配JM14010
5	JM11001D 4.083kg/m	套芯配JM11002B	14	JM11001GA 5.104kg/m	套芯配JM11010	23	JM11002 2.589kg/m	套芯配JM11010
6	JM11001E 6.087kg/m	套芯配JM11002C	15	JM11009 3.242kg/m	套芯配JM11010	24	JM11002A 3.888kg/m	套芯配JM11010
7	JM11001F 2.341kg/m	套芯配JM11002D	16	JM11009A 2.328kg/m	套芯配JM11010	25	JM11002B 2.676kg/m	套芯配JM11010
8	JM11001G 4.115kg/m	套芯配JM11002D	17	JM11009B 2.782kg/m	套芯配JM11010	26	JM11002C 3.822kg/m	套芯配JM11010
9	JM11001H 2.229kg/m	套芯配JM11002D	18	JM11009D 3.960kg/m	套芯配JM11010C	27	JM11002D 3.803kg/m	套芯配JM11010C

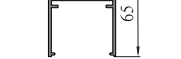
图中所示型材截面、装配、编号、尺寸及重量仅供参考。如有疑问，请向本公司查询。
Information above just for your reference. Please contact us if you have any questions, Thank you!

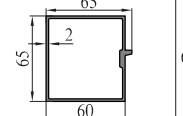
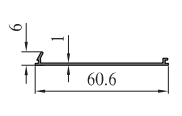
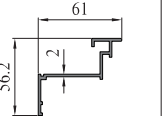
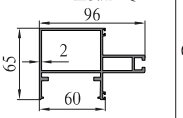
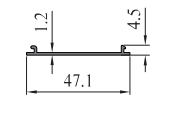
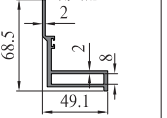
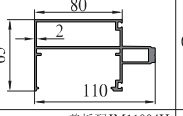
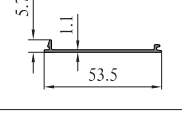
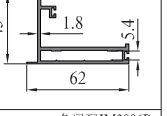
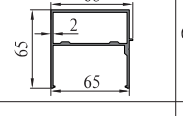
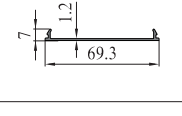
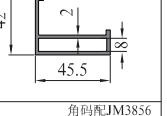
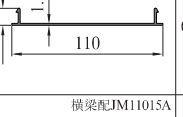
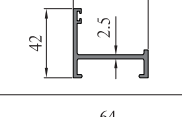
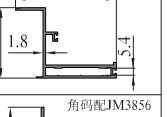
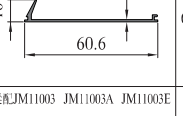
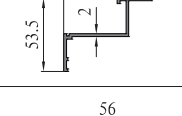
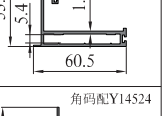

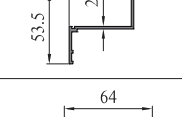
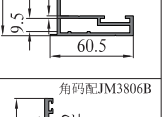
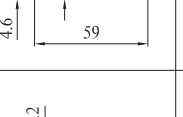
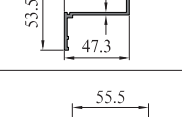
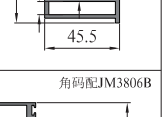
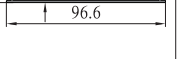

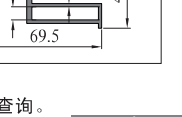

图中所示型材截面、装配、编号、尺寸及重量仅供参考。如有疑问，请向本公司查询。
Information above just for your reference. Please contact us if you have any questions, Thank you!

序号 S/N	型号理论重量 JMA Code & KG/M	型材图 Drawing	序号 S/N	型号理论重量 JMA Code & KG/M	型材图 Drawing	序号 S/N	型号理论重量 JMA Code & KG/M	型材图 Drawing
28	JM11010 2.769kg/m		37	JM11003D 1.765kg/m		46	JM11015E 1.162kg/m	
29	JM12010A 2.484kg/m		38	JM11003E 3.899kg/m		47	JM11015F 1.855kg/m	
30	JM14010 2.739kg/m		39	JM11003H 1.818kg/m		48	JM11015G 1.724kg/m	
31	JM11010C 3.377kg/m		40	JM11003P 1.792kg/m		49	JM11015J 1.813kg/m	
32	JM11002K 2.384kg/m		41	JM110152S 1.886kg/m		50	JM11015M 2.037kg/m	
33	JM11003 2.042kg/m		42	JM11015A 1.785kg/m		51	JM11015N 2.757kg/m	
34	JM11003A 2.956kg/m		43	JM11015B 2.192kg/m		52	JM11015P 1.614kg/m	
35	JM11003B 2.170kg/m		44	JM11015C 2.348kg/m		53	JM11015R 3.012kg/m	
36	JM11003C 0.691kg/m		45	JM11015D 1.698kg/m		54	JM11015T 1.501kg/m	

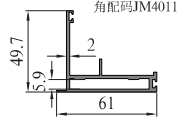
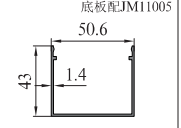
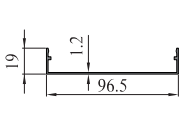
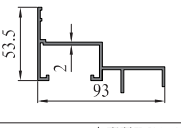
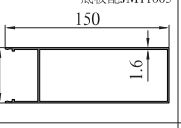
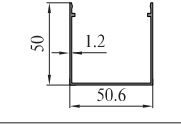
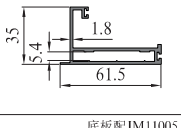
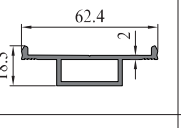
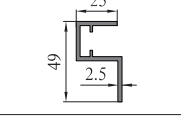
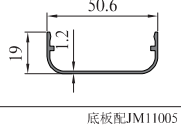
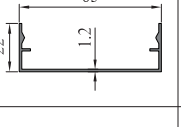
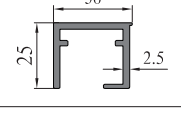
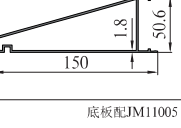
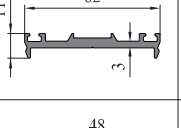
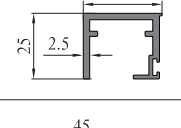
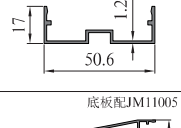
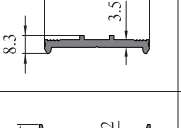
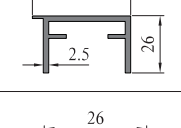
序号 S/N	型号理论重量 JMA Code & KG/M	型材图 Drawing	序号 S/N	型号理论重量 JMA Code & KG/M	型材图 Drawing	序号 S/N	型号理论重量 JMA Code & KG/M	型材图 Drawing
55	JM11015U 1.548kg/m		64	JM11004H 0.202kg/m		73	JM11012G 0.820kg/m	
56	JM11015W 2.132kg/m		65	JMGR0152 0.193kg/m		74	JM11013 1.138kg/m	
57	JM11015X 2.360kg/m		66	MQ16006 0.200kg/m		75	JM11013A 0.977kg/m	
58	JM11015Y 1.555kg/m		67	JM14054B 0.295kg/m		76	JM11013B 0.867kg/m	
59	JM11004 0.528kg/m		68	JM11012 0.794kg/m		77	JM11013C 1.151kg/m	
60	JM11004A 0.219kg/m		69	JM11012A 0.751kg/m		78	JM11013D 1.035kg/m	
61	JM11004B 0.532kg/m		70	JM11012B 0.704kg/m		79	JM11013E 1.155kg/m	
62	JM11004D 0.224kg/m		71	JM11012C 0.703kg/m		80	JM11014 0.892kg/m	
63	JM11004F 0.387kg/m		72	JM11012D 0.677kg/m		81	JM11014A 1.038kg/m	

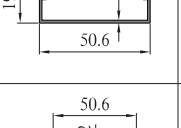
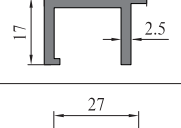
图中所示型材截面、装配、编号、尺寸及重量仅供参考。如有疑问，请向本公司查询。
 Information above just for your reference. Please contact us if you have any questions, Thank you!

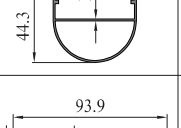
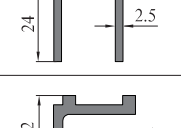
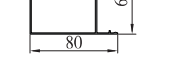
图中所示型材截面、装配、编号、尺寸及重量仅供参考。如有疑问，请向本公司查询。
 Information above just for your reference. Please contact us if you have any questions, Thank you!

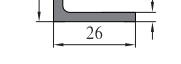
序号 S/N	型号理论重量 JMA Code & KG/M	型材图 Drawing	序号 S/N	型号理论重量 JMA Code & KG/M	型材图 Drawing	序号 S/N	型号理论重量 JMA Code & KG/M	型材图 Drawing
82	JM11013F 1.042kg/m	角配码JM4011 	91	JM11006Y 0.568kg/m	底板配JM11005 	100	JM11006A 0.494kg/m	
83	JM11012H 1.294kg/m		92	JM11006Z 1.859kg/m	底板配JM11005 	101	JM11006B 0.548kg/m	
84	JM11013G 0.929kg/m	角配码JM3856 	93	JM11005J 0.705kg/m		102	JM11008P 0.745kg/m	
85	JM11006CA 0.310kg/m	底板配JM11005 	94	MQ160A17 0.419kg/m		103	JM11008Q 0.610kg/m	
86	JM11006J 1.940kg/m	底板配JM11005 	95	MQ160A18 0.775kg/m		104	JM11008R 0.604kg/m	
87	JM11006K 0.352kg/m	底板配JM11005 	96	JM11005 0.537kg/m		105	JM11008T 0.739kg/m	
88	JM11006L 1.947kg/m	底板配JM11005 	97	JM11006 0.333kg/m		106	JM11008U 0.397kg/m	
89	JM11006V 1.477kg/m	底板配JM11005 	98	JM11006C 0.605kg/m		107	JM11008X 0.494kg/m	
90	JM11006W 1.022kg/m	底板配JM11005J 	99	JM11005A 1.008kg/m		108	JM11008 0.646kg/m	

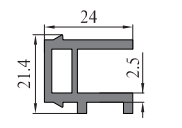
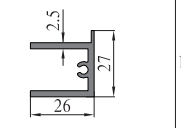
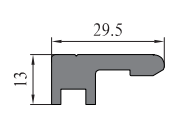
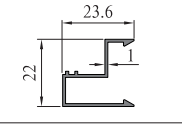
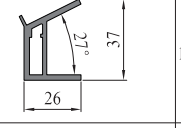
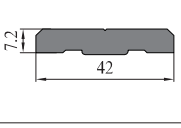
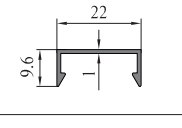
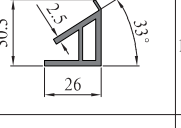
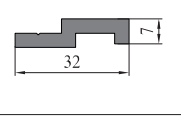
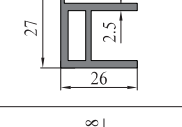
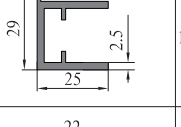
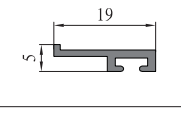
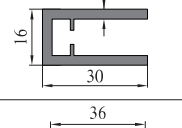
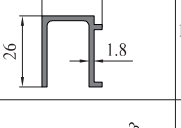
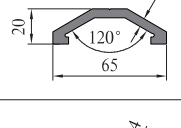
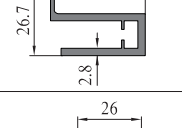
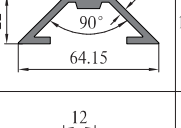
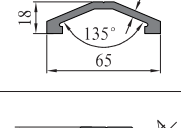
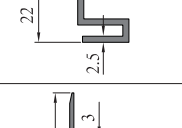
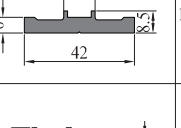
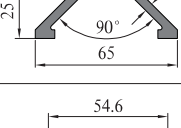
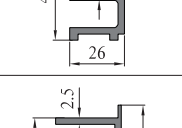
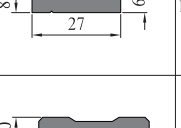
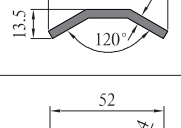
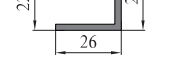
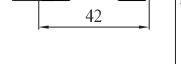
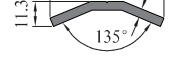
序号 S/N	型号理论重量 JMA Code & KG/M	型材图 Drawing	序号 S/N	型号理论重量 JMA Code & KG/M	型材图 Drawing	序号 S/N	型号理论重量 JMA Code & KG/M	型材图 Drawing
109	JM11008A 0.529kg/m		118	JM11008K 0.564kg/m		127	JM11016 0.598kg/m	
110	JM11008B 0.211kg/m		119	JM11008L 0.704kg/m		128	JM11016B 0.870kg/m	
111	JM11008C 0.124kg/m		120	JM11008M 0.615kg/m		129	JM11016C 0.456kg/m	
112	JM11008D 0.612kg/m		121	JM11008N 0.557kg/m		130	JM11016D 0.108kg/m	
113	JM11008E 0.596kg/m		122	JM11008Y 0.392kg/m		131	JM11017 1.236kg/m	
114	JM11008F 0.703kg/m		123	JM11017B 0.942kg/m		132	JM11017A 1.031kg/m	
115	JM11008G 0.589kg/m		124	JM11016E 0.699kg/m		133	JM11019 1.095kg/m	
116	JM11008H 0.761kg/m		125	JM11016F 0.465kg/m		134	JM11018 0.677kg/m	
117	JM11008J 0.523kg/m		126	JM11007 1.070kg/m		135	JM11018A 0.624kg/m	

图中所示型材截面、装配、编号、尺寸及重量仅供参考。如有疑问，请向本公司查询。
 Information above just for your reference. Please contact us if you have any questions, Thank you!

图中所示型材截面、装配、编号、尺寸及重量仅供参考。如有疑问，请向本公司查询。
 Information above just for your reference. Please contact us if you have any questions, Thank you!

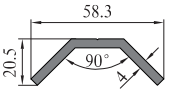
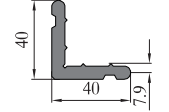
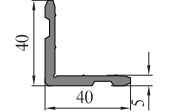
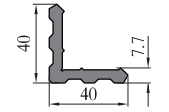
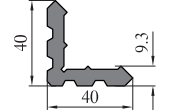
序号 S/N	型号理论重量 JMA Code & KG/M	型材图 Drawing	序号 S/N	型号理论重量 JMA Code & KG/M	型材图 Drawing	序号 S/N	型号理论重量 JMA Code & KG/M	型材图 Drawing
136	JM11020 0.813kg/m		145			154		
137	JM11021 1.349kg/m		146			155		
138	JM3856 0.890kg/m		147			156		
139	JM3806B 1.207kg/m		148			157		
140	Y14524 1.408kg/m		149			158		
141			150			159		
142			151			160		
143			152			161		
144			153			162		

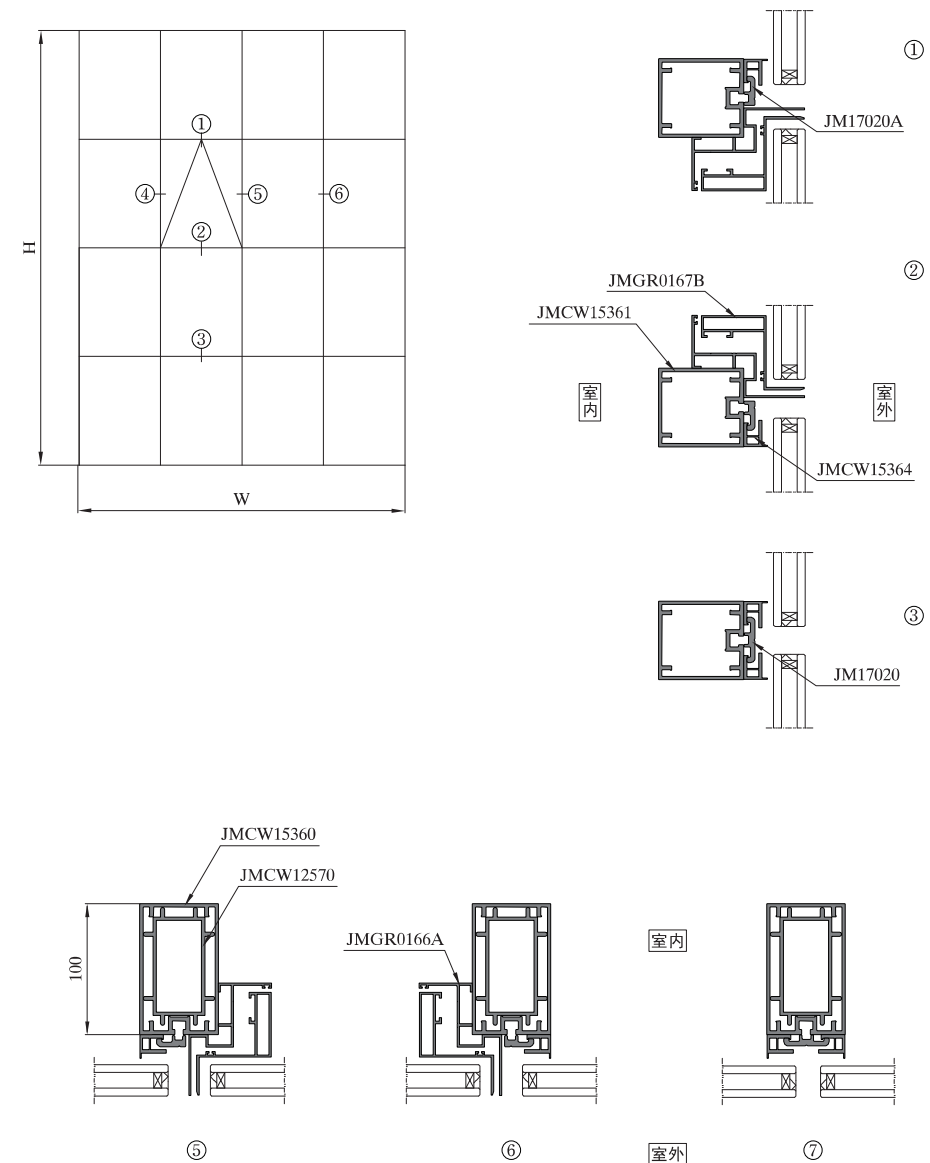

图中所示型材截面、装配、编号、尺寸及重量仅供参考。如有疑问，请向本公司查询。
 Information above just for your reference. Please contact us if you have any questions, Thank you!

图中所示型材截面、装配、编号、尺寸及重量仅供参考。如有疑问，请向本公司查询。
 Information above just for your reference. Please contact us if you have any questions, Thank you!

序号 S/N	型号理论重量 JMA Code & KG/M	型材图 Drawing	序号 S/N	型号理论重量 JMA Code & KG/M	型材图 Drawing	序号 S/N	型号理论重量 JMA Code & KG/M	型材图 Drawing
1	JMCW15359 3.146kg/m		10	JMCW15368 0.337kg/m		19	JMGR0167 0.761kg/m	角码配JM3824
2	JMCW15360 2.853kg/m	套芯配JMCW12570 	11	JMCW15369 0.395kg/m		20	JMGR0167A 0.927kg/m	角码配JM3824
3	JMCW15361 2.341kg/m		12	JMCW15364 0.372kg/m		21	JMGR0167B 1.022kg/m	角码配JM3824
4	JMCW15362 2.286kg/m		13	JM17020 0.483kg/m		22		
5	JMCW15363 1.975kg/m		14	JM17020A 0.337kg/m		23		
6	JMCW15639 1.711kg/m		15	JMCW15367 0.852kg/m	角码配PC386682 	24		
7	JMCW15640 1.998kg/m		16	JMGR0166 0.599kg/m		25		
8	JMCW15641 1.874kg/m		17	JMGR0166A 0.962kg/m		26		
9	JMCW12570 2.107kg/m		18	JMCW15366 0.942kg/m	角码配PC386682 	27		

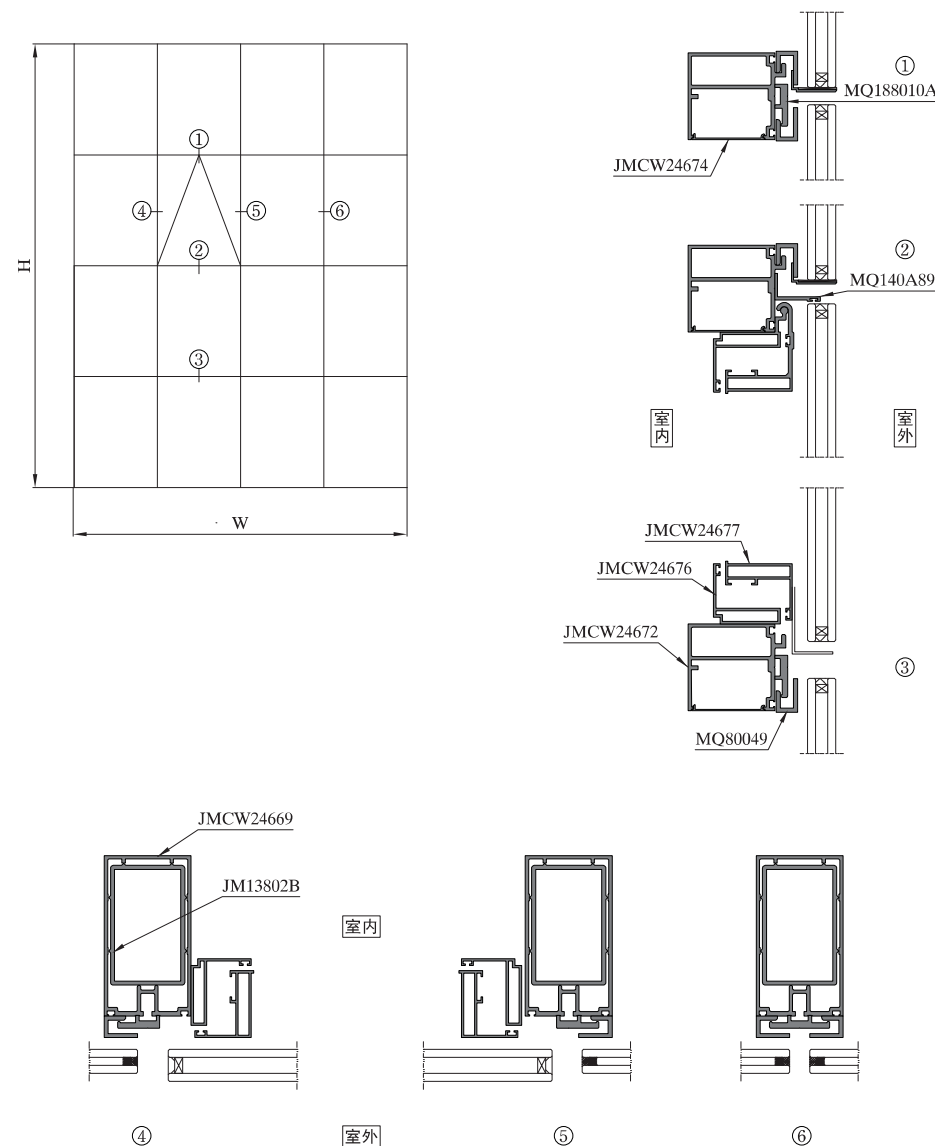

图中所示型材截面、装配、编号、尺寸及重量仅供参考。如有疑问，请向本公司查询。
Information above just for your reference. Please contact us if you have any questions, Thank you!

图中所示型材截面、装配、编号、尺寸及重量仅供参考。如有疑问，请向本公司查询。
Information above just for your reference. Please contact us if you have any questions, Thank you!

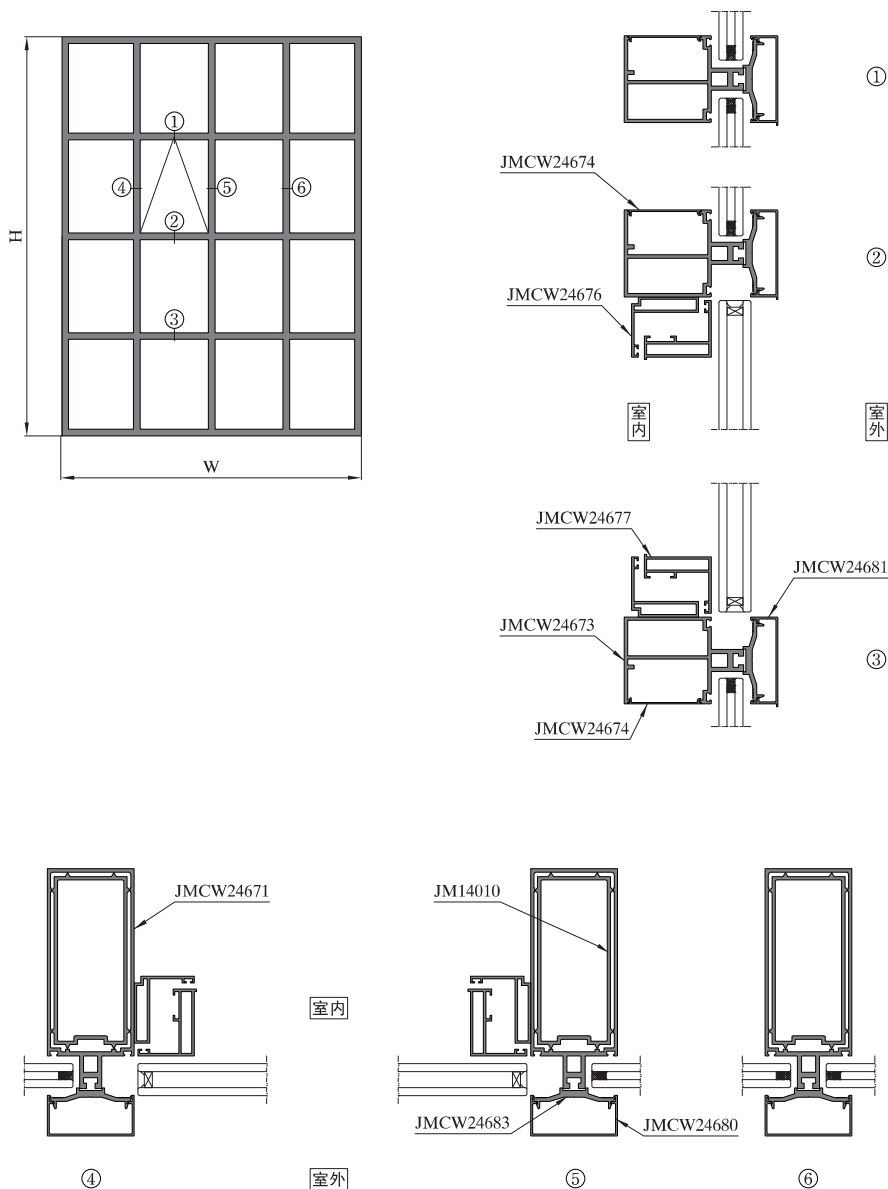

序号 S/N	型号理论重量 JMA Code & KG/M	型材图 Drawing	序号 S/N	型号理论重量 JMA Code & KG/M	型材图 Drawing	序号 S/N	型号理论重量 JMA Code & KG/M	型材图 Drawing
1	JMCW24669 3.185kg/m	套芯配JM13802B 65 2.5 120	10	JMCW24676 0.821kg/m	角码配JM3806B 45 1.8 50	19	JMCW24819 3.159kg/m	65 2.5 139
2	JMCW24670 3.374kg/m	套芯配JM12010A 120 65 2.5 144.35	11	JMCW24677 0.878kg/m	角码配JM3806B 44 1.8 50	20	JMCW24820 0.135kg/m	7.35 23.7 1.5
3	JMCW24671 3.693kg/m	套芯配JM14010 140 65 2.5 164.35	12	JMCW24678 1.032kg/m	角码配JM3806B 63.8 1.8 55.8	21	JMCW24821 2.478kg/m	50.08 6 24.4 129.39
4	JM13802B 2.470kg/m	58.5 3 91	13	JMCW24679 1.282kg/m	角码配JM3806B 88 3 1.8 50	22	JMCW24822 0.288kg/m	41.31 1.2 51.1
5	JM12010A 2.484kg/m	113.5 58.5 2.5 120	14	JMCW24680 0.573kg/m	底板配JMCW24683 30.3 1.5 65	23	MQ140A89 0.342kg/m	2.4 20 33.94
6	JM14010 2.739kg/m	58.6 2.5 131.9	15	JMCW24681 0.491kg/m	底板配JMCW24683 20.3 1.5 67	24	MQ80049 0.445kg/m	16 25 3
7	JMCW24672 2.227kg/m	73 65 2.5 65	16	JMCW24682 1.080kg/m	底板配JMCW24683 45.3 2 65	25	MQ188010 0.672kg/m	4 45 2.5
8	JMCW24673 2.565kg/m	65 65 2.5 89.35	17	JMCW24683 0.738kg/m	61 15.7 5	26	MQ188010A 0.510kg/m	9.5 4 31.5
9	JMCW24674 0.202kg/m	4.6 1.1 54.6	18	JMCW24818 1.130kg/m	62 31.2 5.1 24.4	27	JM13805A 0.504kg/m	21 22 2.5

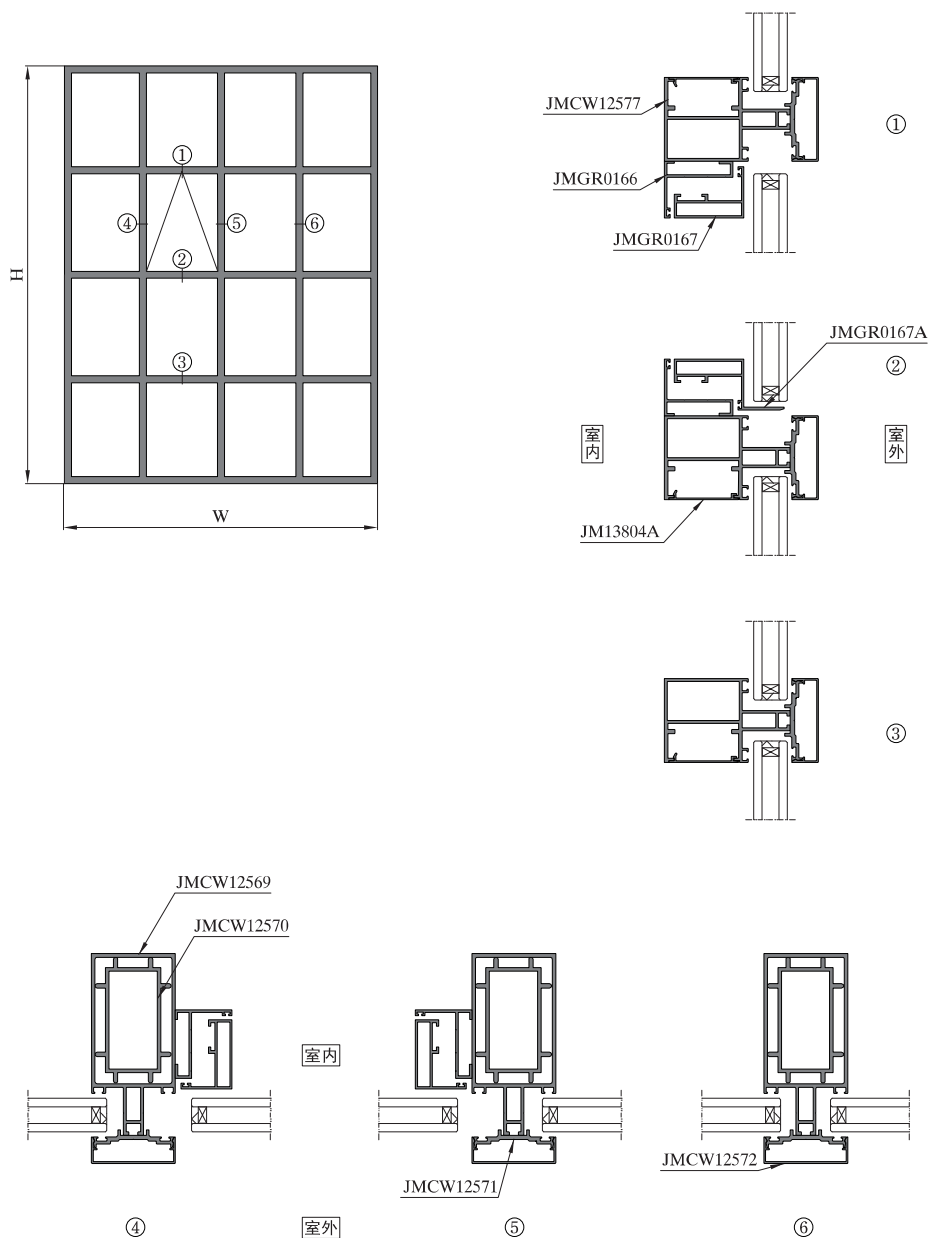

序号 S/N	型号理论重量 JMA Code & KG/M	型材图 Drawing	序号 S/N	型号理论重量 JMA Code & KG/M	型材图 Drawing	序号 S/N	型号理论重量 JMA Code & KG/M	型材图 Drawing
1	主梁 JMCW12569 2.792kg/m		10	开启扇 JMGR0167A 0.927kg/m		19		
2	套芯 JMCW12570 2.107kg/m		11	开启扇 JMGR0167B 1.022kg/m		20		
3	横梁 JMCW12577 2.092kg/m		12			21		
4	横梁盖板 JM13804A 0.215kg/m		13			22		
5	底板 JMCW12571 0.589kg/m		14			23		
6	盖板 JMCW12572 0.364kg/m		15			24		
7	开启框 JMGR0166 0.599kg/m		16			25		
8	开启框 JMGR0166A 0.962kg/m		17			26		
9	开启扇 JMGR0167 0.761kg/m		18			27		

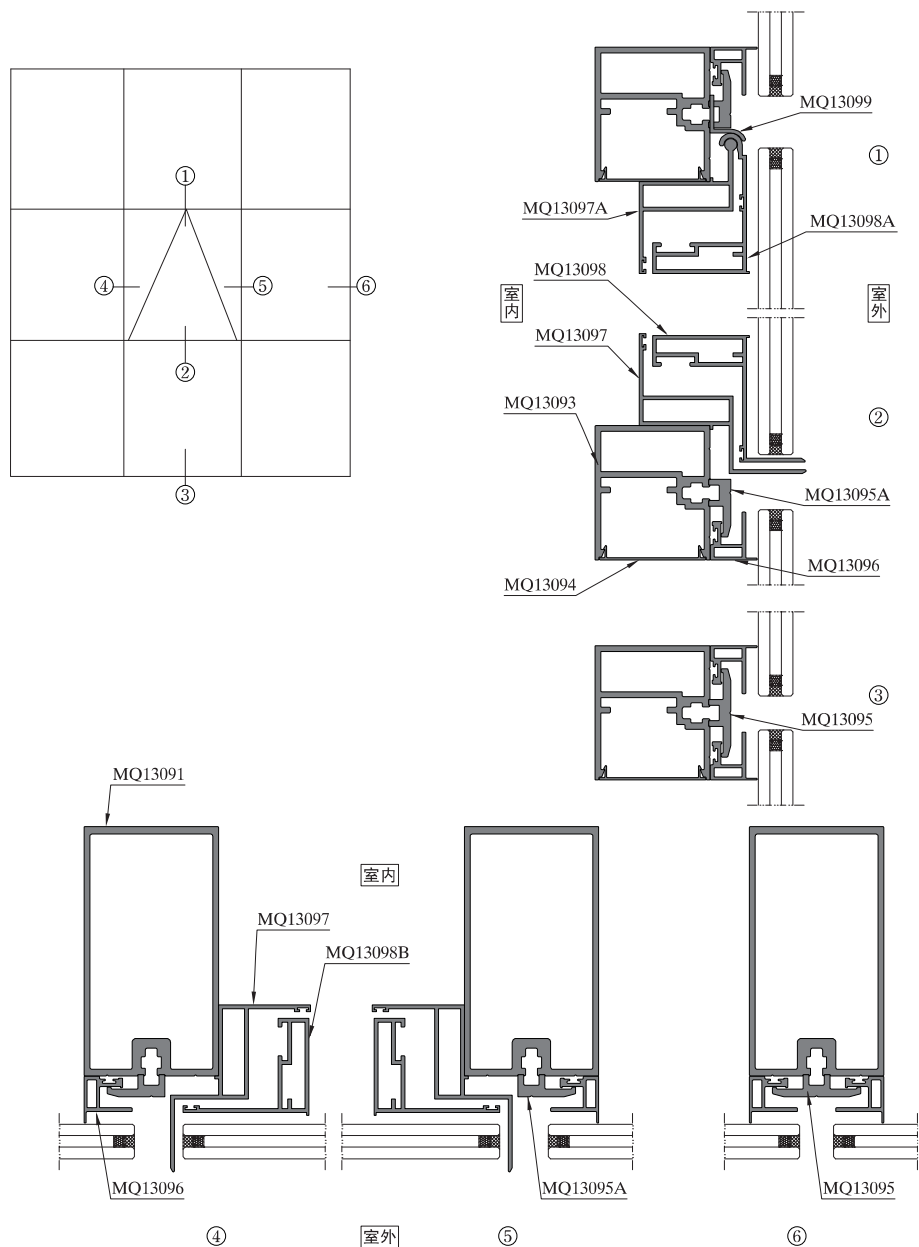

序号 S/N	型号理论重量 JMA Code & KG/M	型材图 Drawing	序号 S/N	型号理论重量 JMA Code & KG/M	型材图 Drawing	序号 S/N	型号理论重量 JMA Code & KG/M	型材图 Drawing
1	JMCW08206 4.398kg/m	套芯配JMCW08207 	10	JMLY0109 4.067kg/m	盖板配MQ13094 	19	JMGR21659 1.583kg/m	
2	JMCW08192 3.428kg/m	套芯配JMCW08247 	11	MQ13093 2.520kg/m	盖板配MQ13094 	20	MQ13097 1.282kg/m	
3	JMCW08248 2.487kg/m	套芯配JMCW08249 	12	JMGR21603 2.333kg/m	盖板配JM13804B 	21	MQ13097A 1.129kg/m	
4	JMGR21604 3.456kg/m	套芯配JMLY0109 	13	JMCW08193 2.097kg/m	横梁盖板配 JMCW08194 	22	MQ13098 1.283kg/m	角码配JM4026A66
5	MQ13091 4.269kg/m		14	JMCW15031 3.022kg/m	盖板配JM13804B 	23	MQ13098A 1.245kg/m	角码配JM4026A66
6	JMGR21614 3.514kg/m	套芯配JMLY0109 	15	MQ13094 0.227kg/m	盖板配JM13804B 	24	MQ13098B 1.105kg/m	角码配JM4026A66
7	JMCW08207 2.630kg/m	套芯配JMLY0109 	16	JM13804B 0.246kg/m	盖板配JM13804B 	25	MQ13096 0.445kg/m	
8	JMCW08247 2.123kg/m	套芯配JMLY0109 	17	JMCW08194 0.216kg/m	盖板配JM13804B 	26	MQ13095 0.699kg/m	
9	JMCW08249 1.811kg/m	套芯配JMLY0109 	18	JMGR21615 1.443kg/m	盖板配JM13804B 	27	MQ13095A 0.519kg/m	





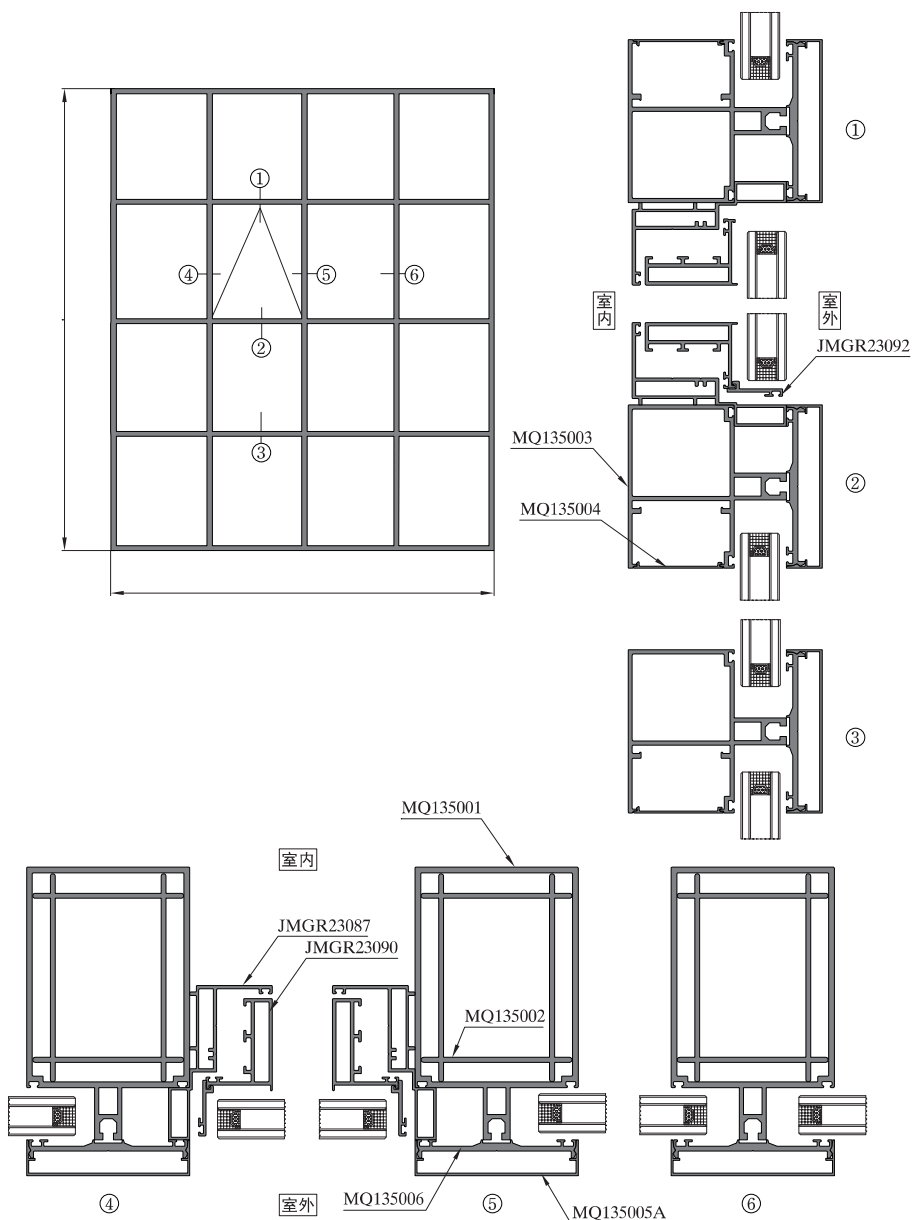



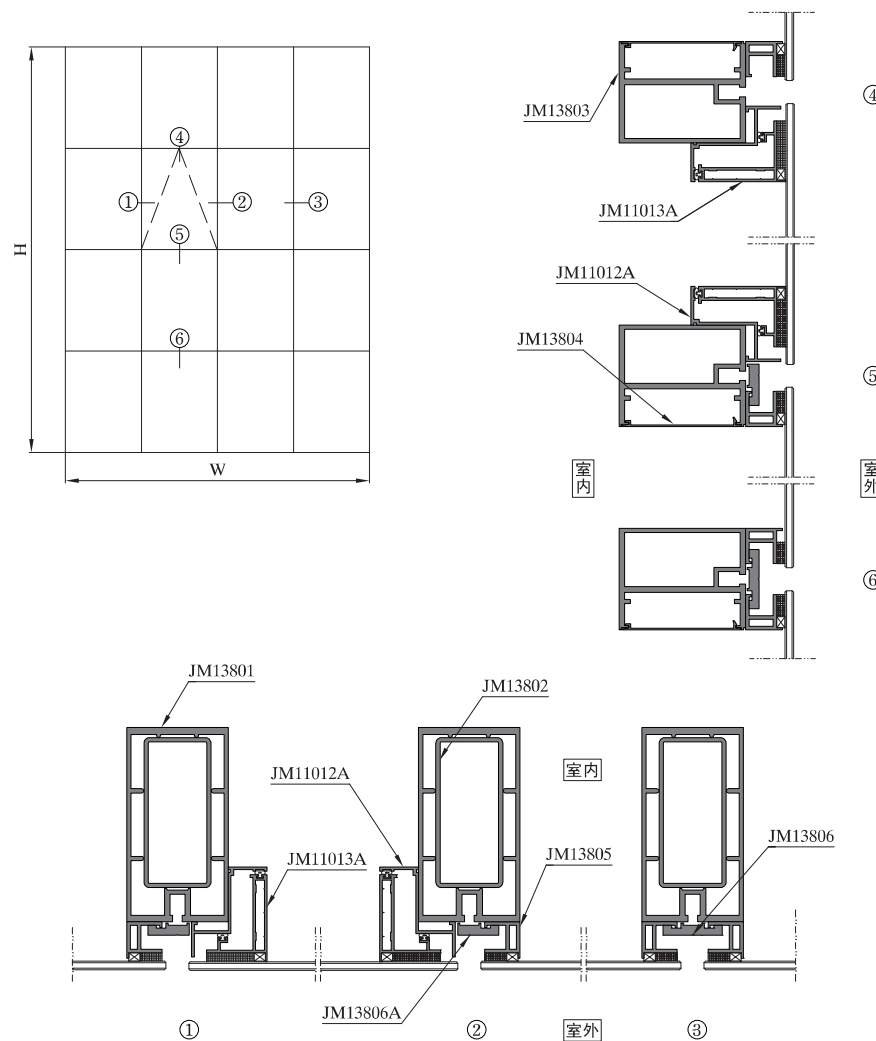
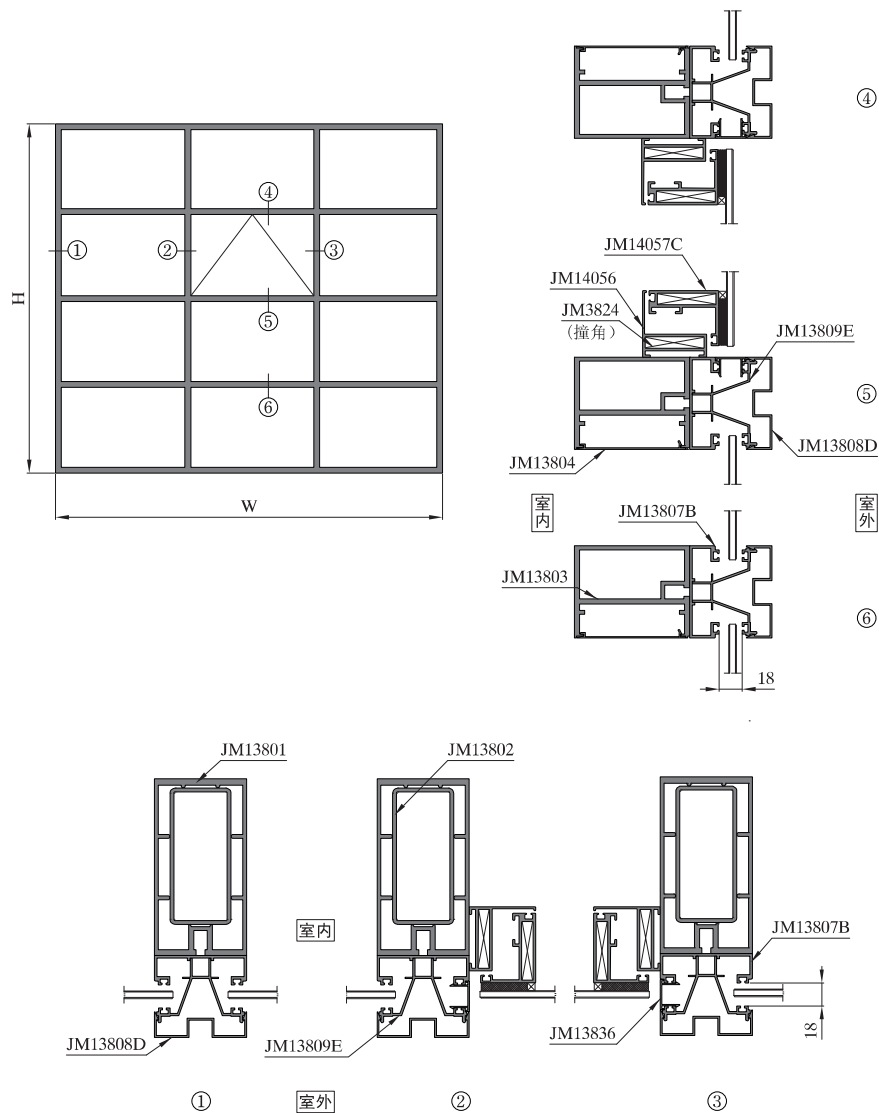

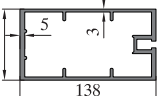
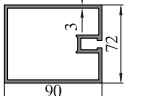
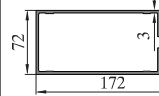
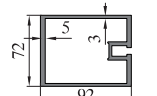
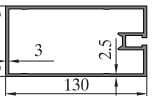
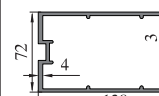
图中所示型材截面、装配、编号、尺寸及重量仅供参考。如有疑问，请向本公司查询。
Information above just for your reference. Please contact us if you have any questions, Thank you!

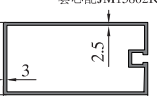
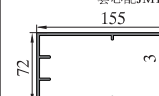
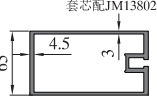
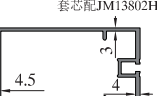

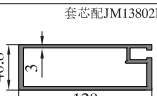
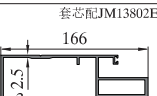
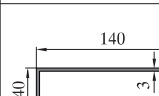
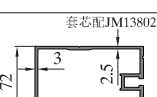
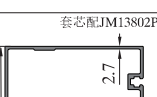
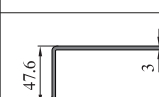
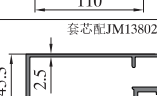
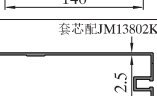
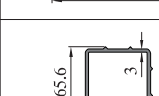
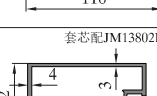

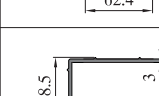



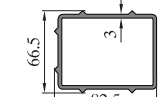
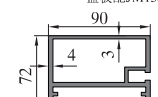
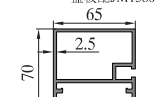
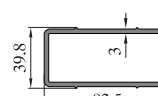
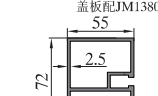
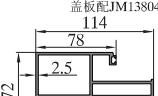
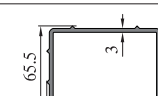

图中所示型材截面、装配、编号、尺寸及重量仅供参考。如有疑问，请向本公司查询。
Information above just for your reference. Please contact us if you have any questions, Thank you!

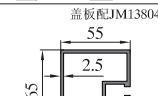
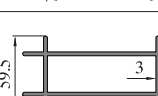
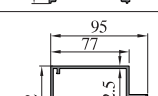
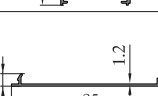
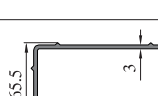

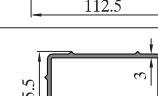
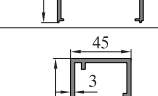
序号 S/N	型号理论重量 JMA Code & KG/M	型材图 Drawing	序号 S/N	型号理论重量 JMA Code & KG/M	型材图 Drawing	序号 S/N	型号理论重量 JMA Code & KG/M	型材图 Drawing
1	MQ135001 5.350kg/m		10	JMGR23088 1.433kg/m		19		
2	MQ135002 3.736kg/m		11	JMGR23089 0.657kg/m		20		
3	MQ135003 3.194kg/m		12	JMGR23090 1.065kg/m		21		
4	MQ135004 0.212kg/m		13	JMGR23091 1.240kg/m		22		
5	MQ135005A 0.658kg/m		14	JMGR23092 0.266kg/m		23		
6	MQ135005B 0.813kg/m		15	JMGR23093 0.409kg/m		24		
7	MQ135006 1.155kg/m		16			25		
8	JMGR23086 1.402kg/m		17			26		
9	JMGR23087 1.399kg/m		18			27		

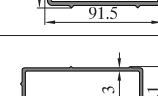

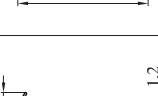
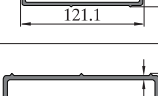
序号 S/N	型号理论重量 JMA Code & KG/M	型材图 Drawing	序号 S/N	型号理论重量 JMA Code & KG/M	型材图 Drawing	序号 S/N	型号理论重量 JMA Code & KG/M	型材图 Drawing
1	JM13801 5.032kg/m	套芯配JM13802 	10	JM13801AC 3.146kg/m	套芯配JM13802A 	19	JM13801X 4.625kg/m	套芯配JM14052 
2	JM13801A 3.889kg/m	套芯配JM13802A 	11	JM13801CB 3.374kg/m	套芯配JM11010 	20	JM13801Z 4.695kg/m	套芯配JM307225 
3	JM13801B 4.525kg/m	套芯配JM13802 	12	JM13801CC 3.217kg/m	套芯配JM13802R 	21	JM13801Y 4.831kg/m	套芯配JM14010B 
4	JM13801C 4.101kg/m	套芯配JM13802B 	13	JM13801U 4.319kg/m	套芯配JM13802H 	22	JM13801M 3.587kg/m	套芯配JM13802J 
5	JM13801D 3.192kg/m	套芯配JM13802D 	14	JM13801EC 4.469kg/m	套芯配JM13802E 	23	JM13801ZA 3.391kg/m	
6	JM13801E 3.386kg/m	套芯配JM13802E 	15	JM13801ED 3.729kg/m	套芯配JM13802P 	24	JM13802 2.563kg/m	
7	JM13801F 2.749kg/m	套芯配JM13802F 	16	JM13801N 4.142kg/m	套芯配JM13802K 	25	JM13802A 2.069kg/m	
8	JM13801H 4.119kg/m	套芯配JM13802H 	17	JM13801P 4.139kg/m	套芯配JM13802L 	26	JM13802B 2.470kg/m	
9	JM13801J 3.838kg/m	套芯配JMF012030 	18	JM13801W 4.646kg/m	套芯配JM13802 	27	JM13802D 2.046kg/m	

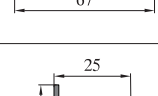
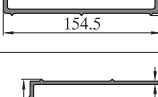
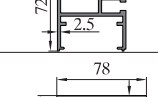
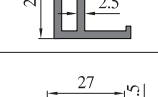
序号 S/N	型号理论重量 JMA Code & KG/M	型材图 Drawing	序号 S/N	型号理论重量 JMA Code & KG/M	型材图 Drawing	序号 S/N	型号理论重量 JMA Code & KG/M	型材图 Drawing
28	JM13802E 2.473kg/m		37	JM13803 3.620kg/m	盖板配JM13804 	46	JM13803L 2.165kg/m	盖板配JM13804B 
29	JM13802F 1.970kg/m		38	JM13803A 2.067kg/m	盖板配JM13804A 	47	JM13803X 3.356kg/m	盖板配JM13804A 
30	JM13802H 2.579kg/m		39	JM13803B 2.074kg/m	盖板配JM13804B 	48	JM13803Z 1.965kg/m	盖板配JM13804A 
31	JM13802R 3.086kg/m		40	JM13803C 2.625kg/m		49	JM13804 0.338kg/m	
32	JM13802L 2.947kg/m		41	JM13803D 2.688kg/m	盖板配JM13804E 	50	JM13804A 0.215kg/m	
33	JM13802H 2.579kg/m		42	JM13803E 2.213kg/m		51	JM13804B 0.246kg/m	
34	JM13802P 3.135kg/m		43	JM13803F 3.362kg/m	盖板配JM13804 	52	JM13804E 0.275kg/m	
35	JM13802K 4.940kg/m		44	JM13803AC 2.179kg/m	盖板配JM13804A 	53	JM13805 0.638kg/m	
36	JM13802N 3.535kg/m		45	JM13803J 2.563kg/m		54	JM13805A 0.504kg/m	

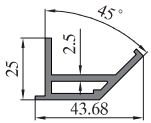
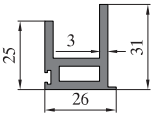
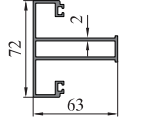
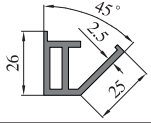
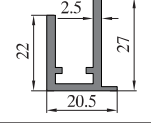
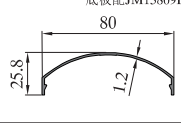
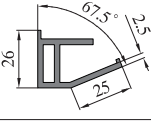
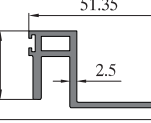
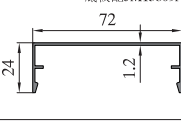
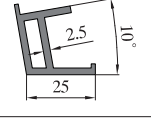
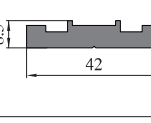
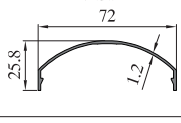
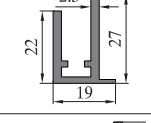
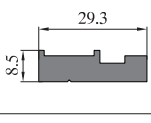
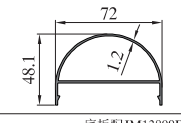
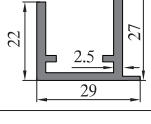
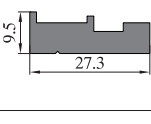
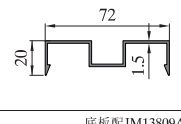
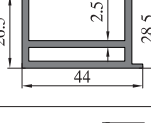
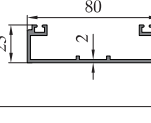
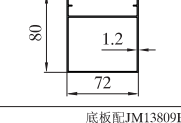
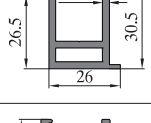
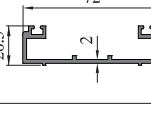
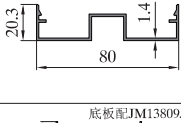
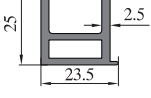
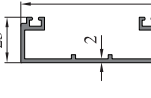
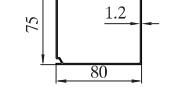
序号 S/N	型号理论重量 JMA Code & KG/M	型材图 Drawing	序号 S/N	型号理论重量 JMA Code & KG/M	型材图 Drawing	序号 S/N	型号理论重量 JMA Code & KG/M	型材图 Drawing
55	JM13805D 0.716kg/m		64	JM13805Q 0.807kg/m		73	JM13807G 1.665kg/m	
56	JM13805E 0.667kg/m		65	JM13805R 0.460kg/m		74	JM13808 0.415kg/m	底板配JM13809B 
57	JM13805F 0.745kg/m		66	JM13805ZA 0.745kg/m		75	JM13808A 0.463kg/m	底板配JM13809A 
58	JM13805G 0.617kg/m		67	JM13806 0.794kg/m		76	JM13808B 0.389kg/m	底板配JM13809C 
59	JM13805H 0.450kg/m		68	JM13806A 0.572kg/m		77	JM13808C 0.855kg/m	底板配JM13809E 
60	JM13805J 0.530kg/m		69	JM13806B 0.537kg/m		78	JM13808D 0.608kg/m	底板配JM13809D 
61	JM13805K 0.932kg/m		70	JM13807 0.930kg/m		79	JM13808AC 1.101kg/m	底板配JM13809A 
62	JM13805M 0.683kg/m		71	JM13807A 0.851kg/m		80	JM13808DA 0.630kg/m	底板配JM13809B 
63	JM13805P 0.564kg/m		72	JM13807B 0.882kg/m		81	JM13808H 0.866kg/m	底板配JM13809J 

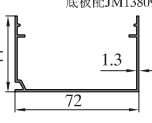
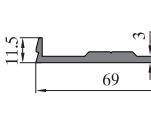
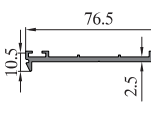
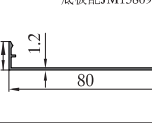
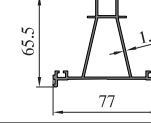
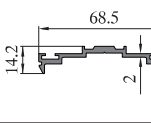
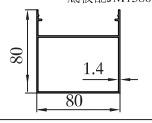
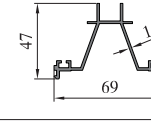
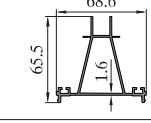
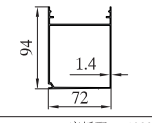
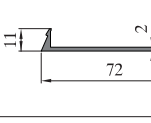
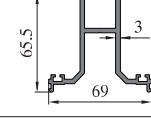
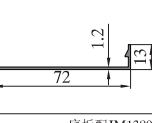
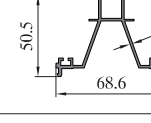
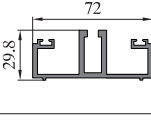
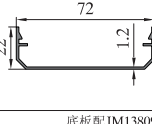
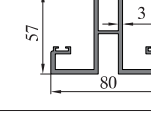
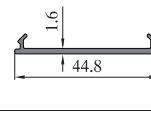
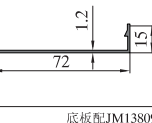
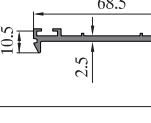
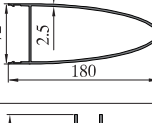
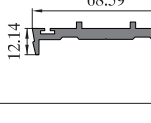
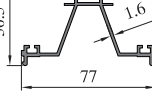
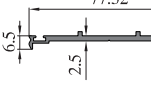
序号 S/N	型号理论重量 JMA Code & KG/M	型材图 Drawing	序号 S/N	型号理论重量 JMA Code & KG/M	型材图 Drawing	序号 S/N	型号理论重量 JMA Code & KG/M	型材图 Drawing
82	JM13808F 0.657kg/m	底板配JM13809G 	91	JM13809A 0.836kg/m		100	JM13809J 0.687kg/m	
83	JM13808HA 0.399kg/m	底板配JM13809JA 	92	JM13809B 1.213kg/m		101	JM13809K 0.640kg/m	
84	JM13808HC 1.323kg/m	底板配JM13809B 	93	JM13809C 0.852kg/m		102	JM13809P 1.172kg/m	
85	JM13808K 1.399kg/m	底板配JM13809K 	94	JM13809D 0.525kg/m		103	JM13809R 1.658kg/m	
86	JM13808W 0.357kg/m	底板配JM13809P 	95	JM13809E 0.883kg/m		104	JM13810 1.502kg/m	
87	JM13808WB 0.434kg/m	底板配JM13809P 	96	JM13809H 2.243kg/m		105	MQ140A06 0.241kg/m	
88	JM13808Z 0.369kg/m	底板配JM13809R 	97	JM13809G 0.629kg/m		106		
89	JM13808Y 3.189kg/m	底板配JM13809A 	98	JM13809M 1.022kg/m		107		
90	JM13809 0.922kg/m		99	JM13809JA 0.583kg/m		108		

图中所示型材截面、装配、编号、尺寸及重量仅供参考。如有疑问，请向本公司查询。
 Information above just for your reference. Please contact us if you have any questions, Thank you!

图中所示型材截面、装配、编号、尺寸及重量仅供参考。如有疑问，请向本公司查询。
 Information above just for your reference. Please contact us if you have any questions, Thank you!

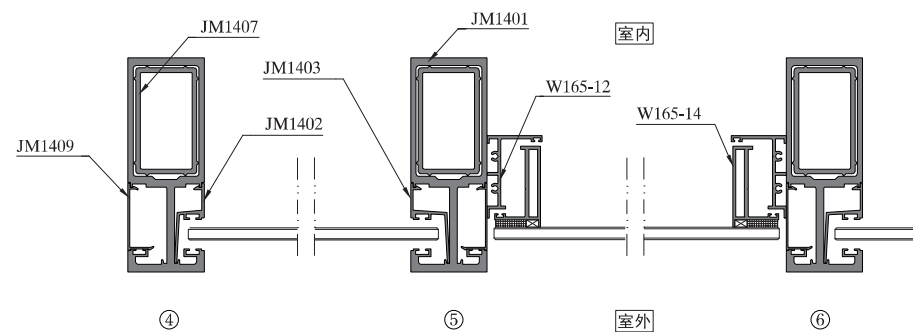
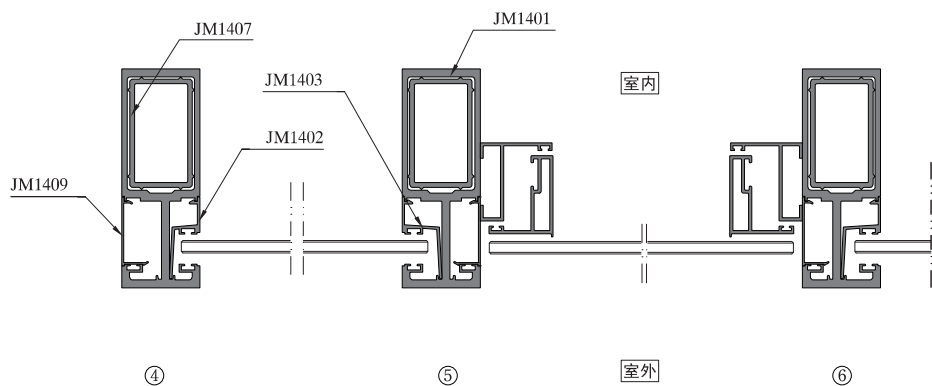
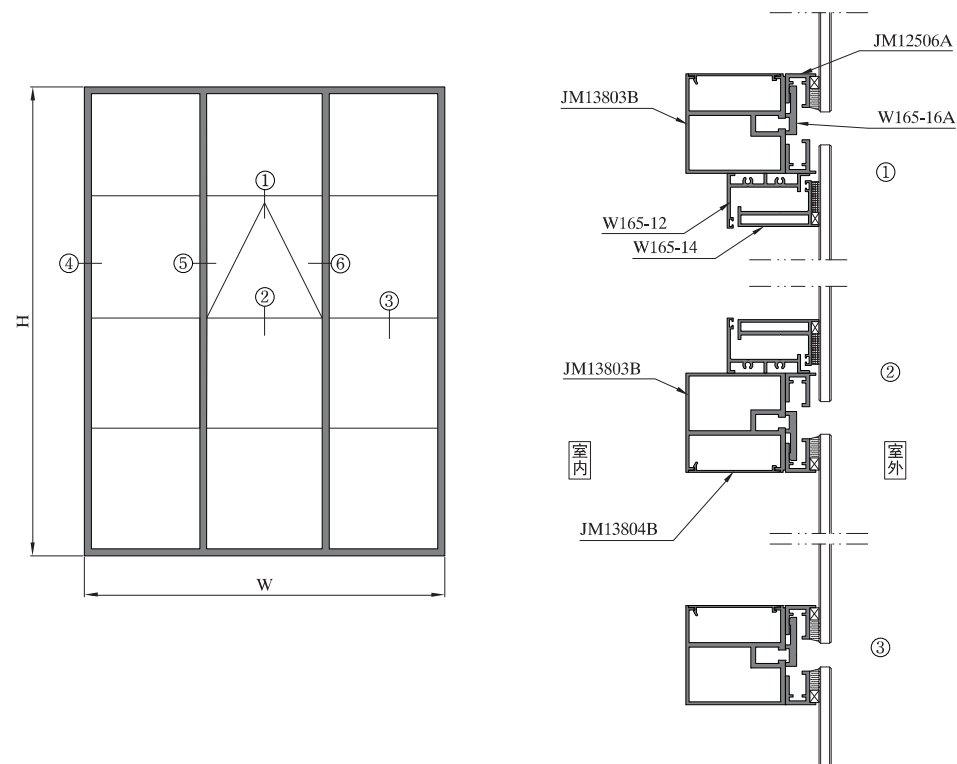
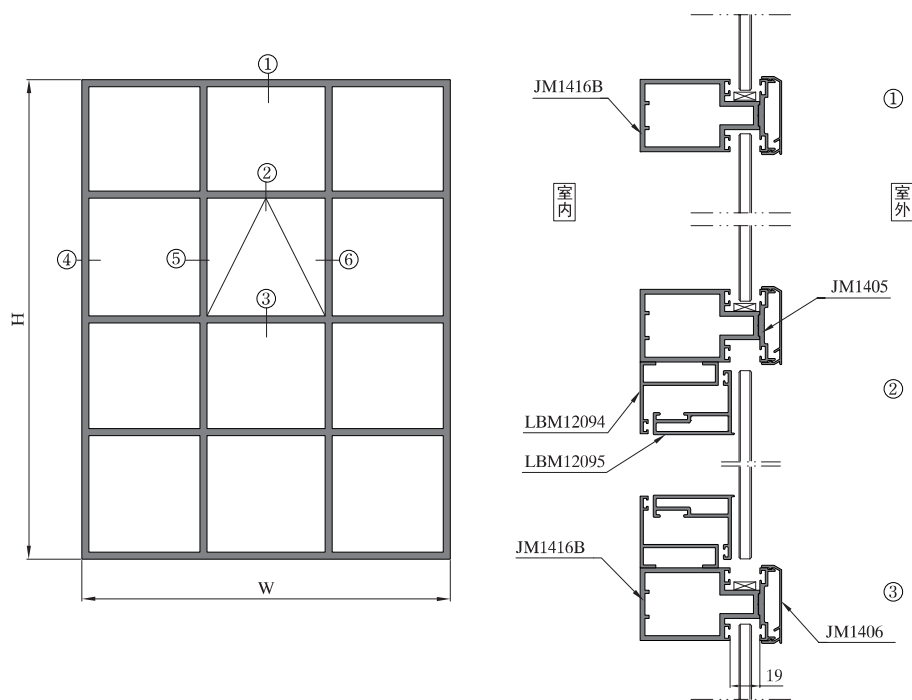

序号 S/N	型号理论重量 JMA Code & KG/M	型材图 Drawing	序号 S/N	型号理论重量 JMA Code & KG/M	型材图 Drawing	序号 S/N	型号理论重量 JMA Code & KG/M	型材图 Drawing
1	JM1201A 3.839kg/m		10	JM1208A 1.828kg/m		19	JM1402 0.415kg/m	
2	JM1401 4.910kg/m		11	JM1407 1.849kg/m		20	JM1402A 0.413kg/m	
3	JM1401A 3.824kg/m		12	JM1407A 1.528kg/m		21	JM1402B 0.471kg/m	
4	JM1401B 4.324kg/m		13	JM1407B 1.898kg/m		22	JM1403 0.448kg/m	
5	JM1401C 3.772kg/m		14	JM1429 5.654kg/m		23	JM1403A 0.438kg/m	
6	JM1501 4.366kg/m		15	JM1429A 5.592kg/m		24	JM1403B 0.504kg/m	
7	JM1501A 4.146kg/m		16	JM1502 2.769kg/m		25	MQ18074 0.572kg/m	
8	JM1701 4.998kg/m		17	JM1702 3.190kg/m		26	MQ18074A 0.529kg/m	
9	MQ18071 6.950kg/m		18	MQ18072 3.128kg/m		27	JM1404 1.167kg/m	

序号 S/N	型号理论重量 JMA Code & KG/M	型材图 Drawing	序号 S/N	型号理论重量 JMA Code & KG/M	型材图 Drawing	序号 S/N	型号理论重量 JMA Code & KG/M	型材图 Drawing
28	JM1405 0.471kg/m		37	JM1415 0.745kg/m		46	JM1423A 0.279kg/m	
29	JM1406 0.293kg/m		38	JM1416 1.374kg/m		47	JM1423B 0.450kg/m	
30	JM1409 0.226kg/m		39	JM1416A 1.463kg/m		48	JM1423C 0.400kg/m	
31	JM1409A 0.218kg/m		40	JM1416B 2.159kg/m		49	JM1426 0.645kg/m	
32	JM1409B 0.204kg/m		41	JM1416C 1.728kg/m		50	JM1428 2.729kg/m	
33	JM1409C 0.249kg/m		42	JM1416D 1.551kg/m		51	JM1430 4.514kg/m	
34	JM1410 1.671kg/m		43	JM1421 2.289kg/m		52	JM1430A 5.281kg/m	
35	JM1413 1.331kg/m		44	JM1422 2.243kg/m		53	LBM12094 0.752kg/m	
36	JM1414 0.171kg/m		45	JM1423 0.342kg/m		54	LBM12095 0.948kg/m	

图中所示型材截面、装配、编号、尺寸及重量仅供参考。如有疑问，请向本公司查询。
Information above just for your reference. Please contact us if you have any questions, Thank you!

图中所示型材截面、装配、编号、尺寸及重量仅供参考。如有疑问，请向本公司查询。
Information above just for your reference. Please contact us if you have any questions, Thank you!

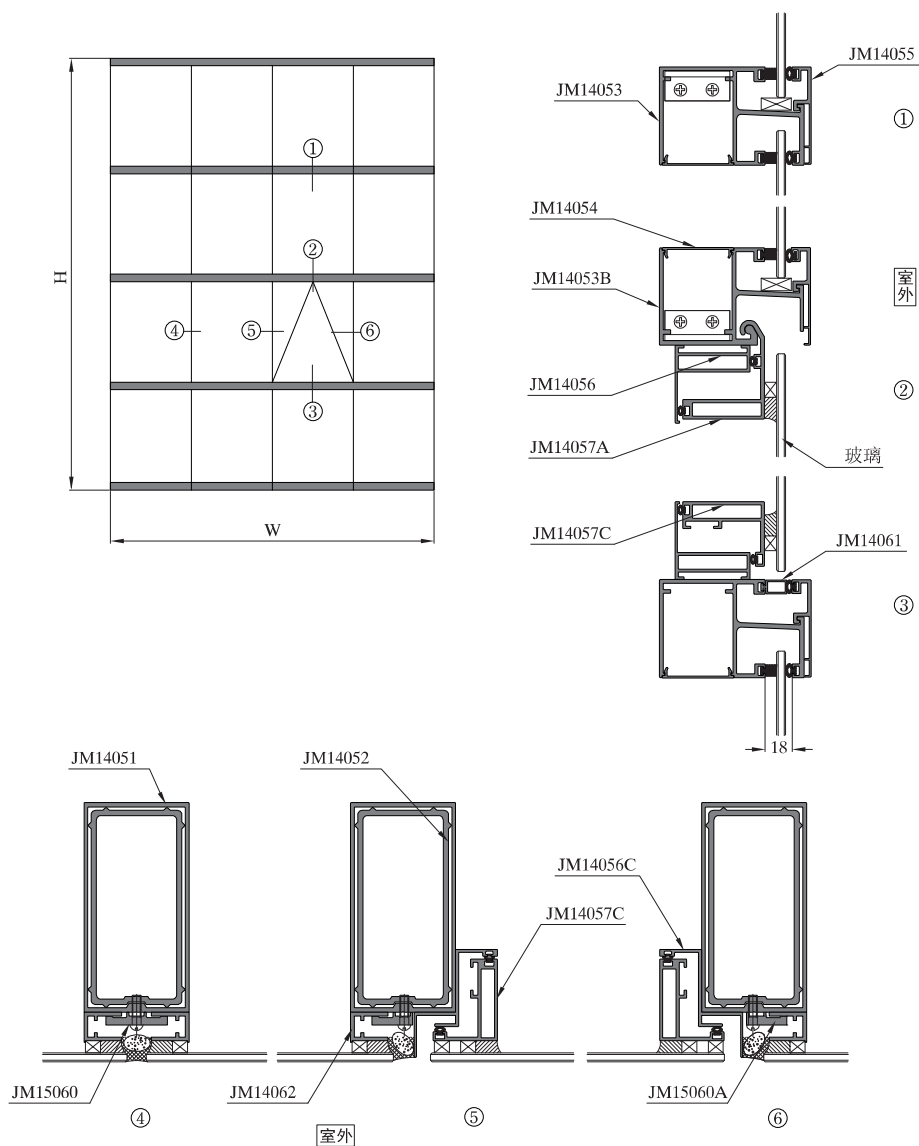

序号 S/N	型号理论重量 JMA Code & KG/M	型材图 Drawing	序号 S/N	型号理论重量 JMA Code & KG/M	型材图 Drawing	序号 S/N	型号理论重量 JMA Code & KG/M	型材图 Drawing
1	JM14051 3.292kg/m	套芯配JM14052 70 x 140 x 3	10	JM14055 0.538kg/m	12.7 x 65 x 1.2	19	JM14058 1.201kg/m	70 x 3.3 x 19
2	JM14052 3.883kg/m	64.5 x 133.5 x 3.5	11	JM14056 0.947kg/m	52 x 50 x 2	20	JM14058C 2.532kg/m	70 x 3 x 51.25 x 77.69
3	JM14053 2.617kg/m	盖板配JM14054 65.5 x 96.5 x 2.5	12	JM14056A 0.589kg/m	55.5 x 44 x 2	21	JM14058D 1.467kg/m	70 x 2.5 x 39
4	JM14053A 2.303kg/m	盖板配JM14054B 70 x 73 x 2.5	13	JM14056B 0.712kg/m	55.5 x 72 x 2	22	JM14058A 0.715kg/m	盖板配JM14060 67.1 x 3 x 10.68
5	JM14053B 2.546kg/m	盖板配JM14054 96 x 65 x 3 x 2.5 x 70	14	JM14056C 0.851kg/m	72 x 55.5 x 2	23	JM14058B 1.121kg/m	盖板配JM14060A 90° x 106.66 x 3
6	JM14053C 2.330kg/m	盖板配JM14054A 92 x 70 x 2.5 x 60	15	JM14057 1.318kg/m	角码配JM3824 66.5 x 62 x 2 x 9	24	JM14060 0.310kg/m	11.96 x 1.2 x 69.5
7	JM14054 0.219kg/m	7 x 47.8 x 1.2	16	JM14057A 1.350kg/m	角码配JM3824 65.9 x 54.5 x 2 x 9	25	JM14060A 0.597kg/m	90° x 20.81 x 1.4 x 117
8	JM14054A 0.249kg/m	7 x 56.3 x 1.2	17	JM14057B 1.373kg/m	角码配JM3824 69 x 58.5 x 2 x 9	26	JM14059 0.630kg/m	19 x 2.5 x 40.76
9	JM14054B 0.295kg/m	7 x 69.3 x 1.2	18	JM14057C 1.116kg/m	角码配JM3824 43.1 x 54.5 x 2 x 9	27	JM14062 0.507kg/m	25 x 2.5 x 20

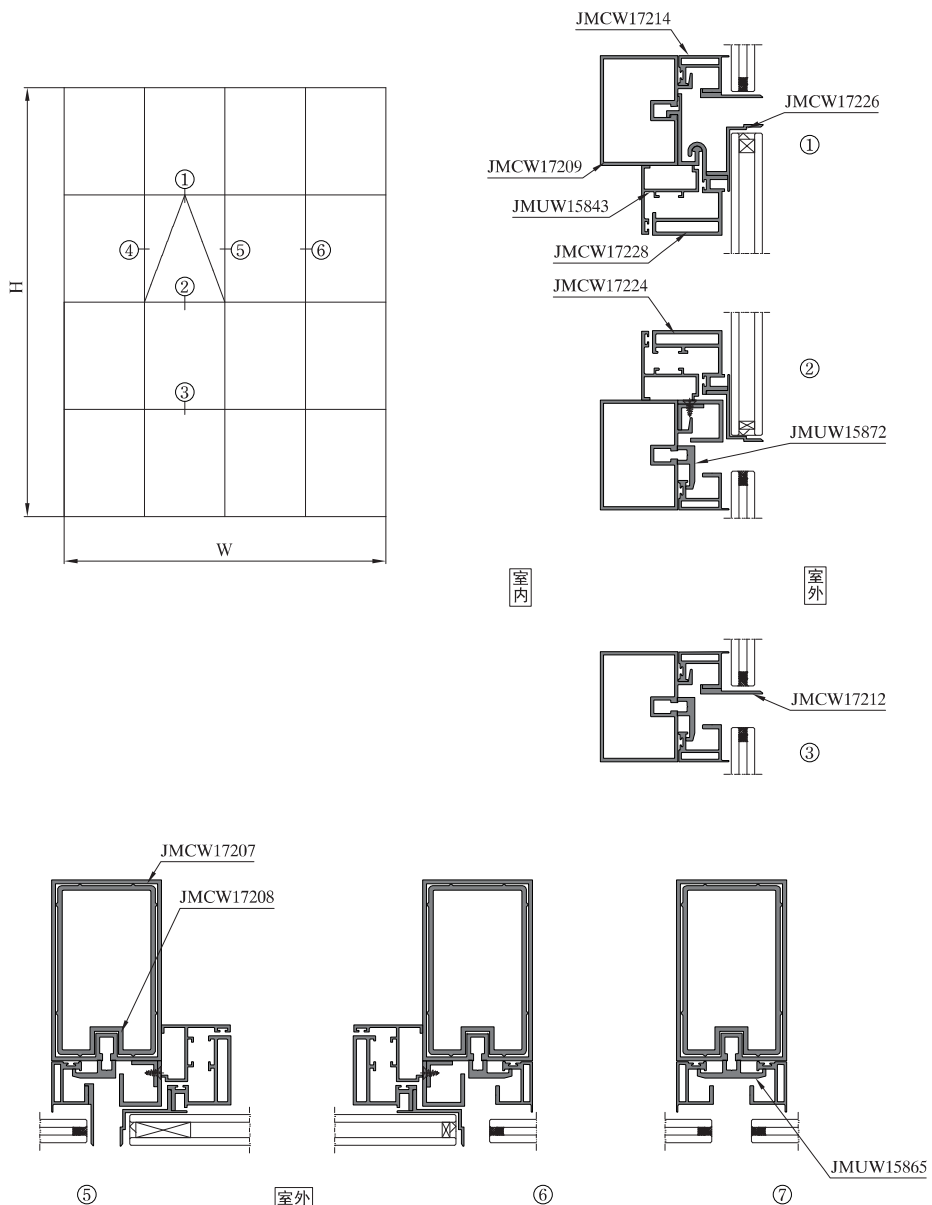

序号 S/N	型号理论重量 JMA Code & KG/M	型材图 Drawing	序号 S/N	型号理论重量 JMA Code & KG/M	型材图 Drawing	序号 S/N	型号理论重量 JMA Code & KG/M	型材图 Drawing
1	JMCW17207 4.229kg/m		10	JMCW17213 0.456kg/m		19	JMCW10331 8.149kg/m	
2	JMCW17208 4.487kg/m		11	JMCW17214 0.847kg/m		20	JMCW10332 4.228kg/m	
3	JMCW17209 2.521kg/m		12	JMCW17216 0.113kg/m		21	JMCW10719 4.908kg/m	
4	JMCW17210 2.940kg/m		13	JMCW17212 0.383kg/m		22	JMCW10720 3.375kg/m	
5	JMCW17217 0.804kg/m		14	JMCW17221 0.766kg/m		23	JMCW18998 0.908kg/m	
6	JMCW17224 1.553kg/m		15	JMUW15872 0.612kg/m		24	JMCW19008 1.138kg/m	
7	JMCW17226 0.622kg/m		16	JMUW15865 0.849kg/m		25	JMCW19009 0.342kg/m	
8	JMCW17228 1.815kg/m		17	JMCW10326 4.657kg/m		26	JMCW19007 0.648kg/m	
9	JMUW15843 0.833kg/m		18	JMCW10327 3.648kg/m		27	JMUW15864 0.693kg/m	

图中所示型材截面、装配、编号、尺寸及重量仅供参考。如有疑问，请向本公司查询。
Information above just for your reference. Please contact us if you have any questions, Thank you!

图中所示型材截面、装配、编号、尺寸及重量仅供参考。如有疑问，请向本公司查询。
Information above just for your reference. Please contact us if you have any questions, Thank you!

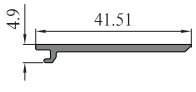
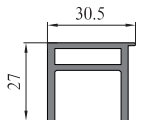
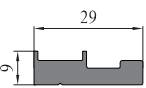
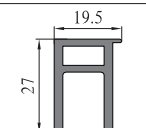
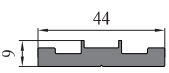
序号 S/N	型号理论重量 JMA Code & KG/M	型材图 Drawing	序号 S/N	型号理论重量 JMA Code & KG/M	型材图 Drawing	序号 S/N	型号理论重量 JMA Code & KG/M	型材图 Drawing
28	JMCW19010 0.248kg/m		37			46		
29	JMCW10347 0.673kg/m		38			47		
30	JMCW10341 0.513kg/m		39			48		
31	JMCW10340 0.543kg/m		40			49		
32	JMCW10342 0.745kg/m		41			50		
33			42			51		
34			43			52		
35			44			53		
36			45			54		

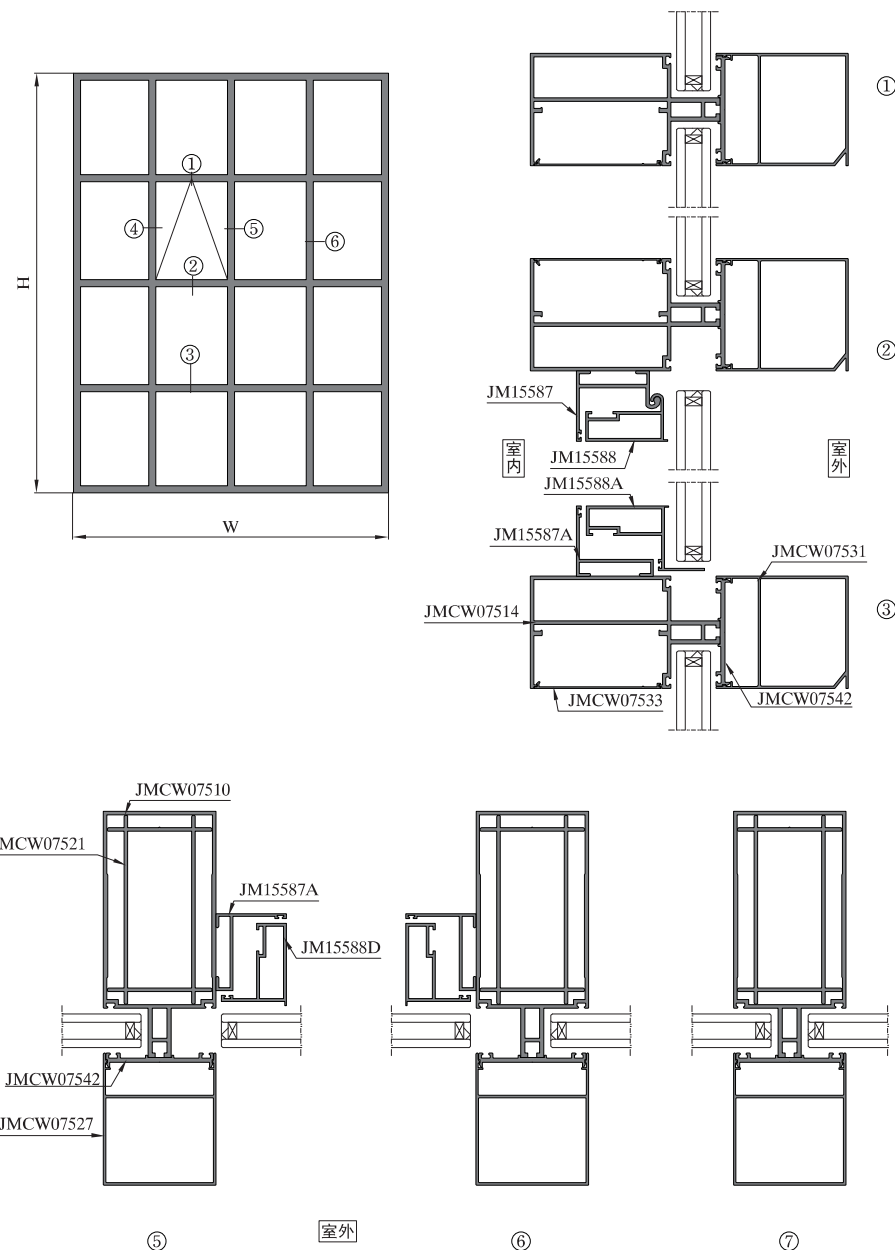

图中所示型材截面、装配、编号、尺寸及重量仅供参考。如有疑问，请向本公司查询。
 Information above just for your reference. Please contact us if you have any questions, Thank you!

图中所示型材截面、装配、编号、尺寸及重量仅供参考。如有疑问，请向本公司查询。
 Information above just for your reference. Please contact us if you have any questions, Thank you!

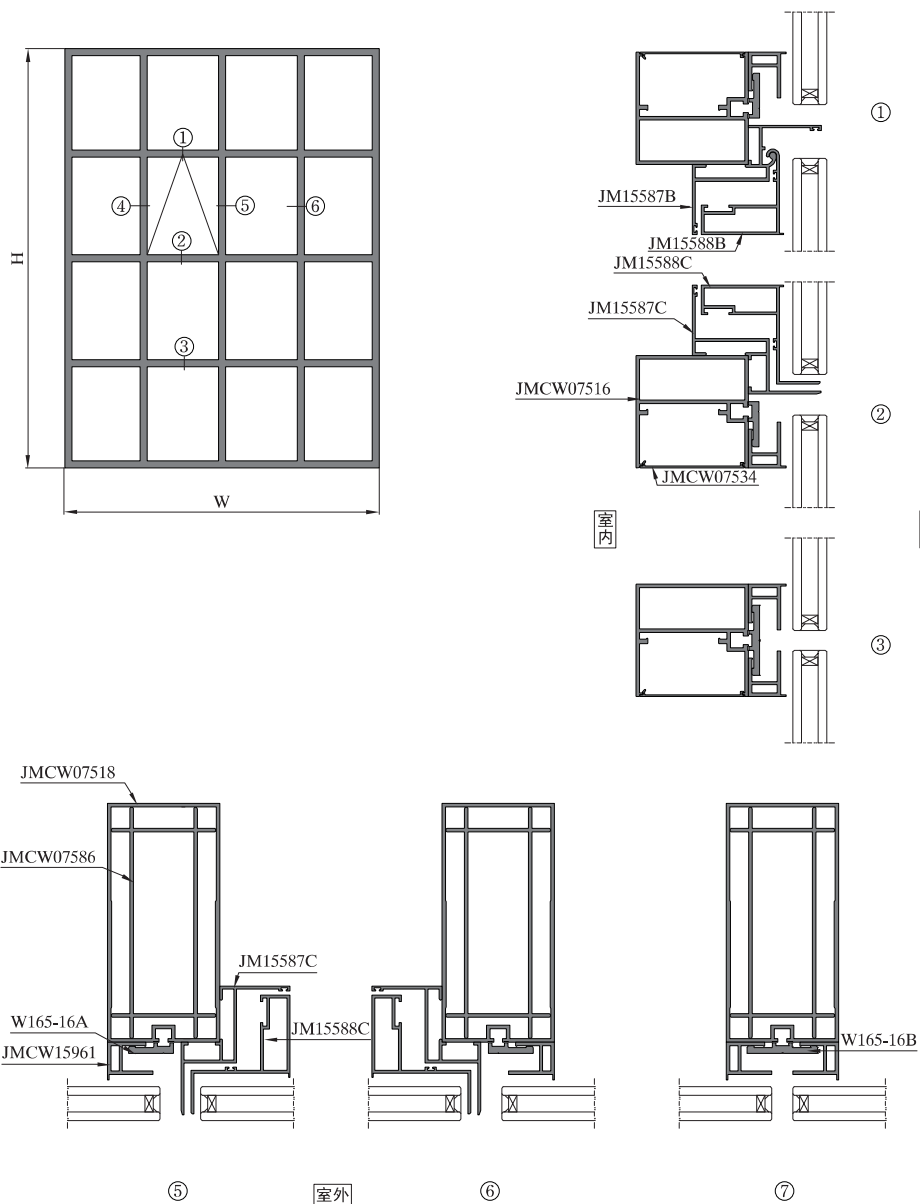

序号 S/N	型号理论重量 JMA Code & KG/M	型材图 Drawing	序号 S/N	型号理论重量 JMA Code & KG/M	型材图 Drawing	序号 S/N	型号理论重量 JMA Code & KG/M	型材图 Drawing
1	JMCW17381 5.092kg/m	套芯配JMCW17382 200 164 80 2.5	10	JMCW07514 3.499kg/m	135 100 80 2.5 91	19	JMCW16153 0.499kg/m	底板配JMCW16152 25 1.2 80
2	JMCW07510 4.146kg/m	套芯配JMCW07521 175 140 80 2.5	11	JMCW07528 2.971kg/m	110 80 2.5 105	20	JMCW16153A 0.502kg/m	底板配JMCW16152 24 1.2 80
3	JMCW07519 4.706kg/m	套芯配JMCW07586 205 170 80 2.5	12	JMCW07516 2.526kg/m	80 80 2.5 75	21	JMCW16152 0.775kg/m	10.85 76.8 3
4	JMCW07518 3.977kg/m	套芯配JMCW07586 170 80 2.5	13	JMCW07533 0.345kg/m	1.2 90.5	22	JMCW07542 0.829kg/m	76.4 10.2 3
5	JMCW07515 4.366kg/m	套芯配JMCW07524 139 80 3 90°	14	JMCW07535 0.454kg/m	5.2 104.5 1.4	23	JM15587 1.023kg/m	52 50 2 59.8
6	JMCW17382 3.737kg/m	149.2 72 3	15	JMCW07534 0.287kg/m	1.2 74.5	24	JM15587A 0.760kg/m	50 2 54.7
7	JMCW07521 2.971kg/m	134.5 74.5 2.5	16	JMCW07527 1.779kg/m	底板配JMCW07542 94 1.8 80	25	JM15587B 1.403kg/m	92 77.5 2 54.7
8	JMCW07586 3.410kg/m	164.5 74.5 2.5	17	JMCW07531 1.797kg/m	底板配: JMCW07542 94 1.8 80	26	JM15587C 1.284kg/m	77.5 2 91.7
9	JMCW07524 2.647kg/m	113.8 73.5 2.5	18	JMCW07756 0.759kg/m	底板配JMCW07542 34 1.5 80	27	JM15588 1.025kg/m	角码配JM5004A 33.8 2 58.5 12.5

序号 S/N	型号理论重量 JMA Code & KG/M	型材图 Drawing	序号 S/N	型号理论重量 JMA Code & KG/M	型材图 Drawing	序号 S/N	型号理论重量 JMA Code & KG/M	型材图 Drawing
28	JM15588A 1.213kg/m		37	W165-16B 0.718kg/m		46		
29	JM15588B 1.212kg/m		38	W165-16A 0.465kg/m		47		
30	JM15588C 1.392kg/m		39	JMCW07559 0.792kg/m		48		
31	JM15588D 1.080kg/m		40	JMCW07560 0.524kg/m		49		
32	JMCW15960 0.612kg/m		41	JMCW07561 0.631kg/m		50		
33	JMCW15961 0.691kg/m		42	JMCW07558 1.436kg/m		51		
34	JM13805D 0.716kg/m		43	JMCW07562 0.661kg/m		52		
35	JM13805E 0.667kg/m		44	JM15589 0.288kg/m		53		
36	JM13805F 0.745kg/m		45			54		

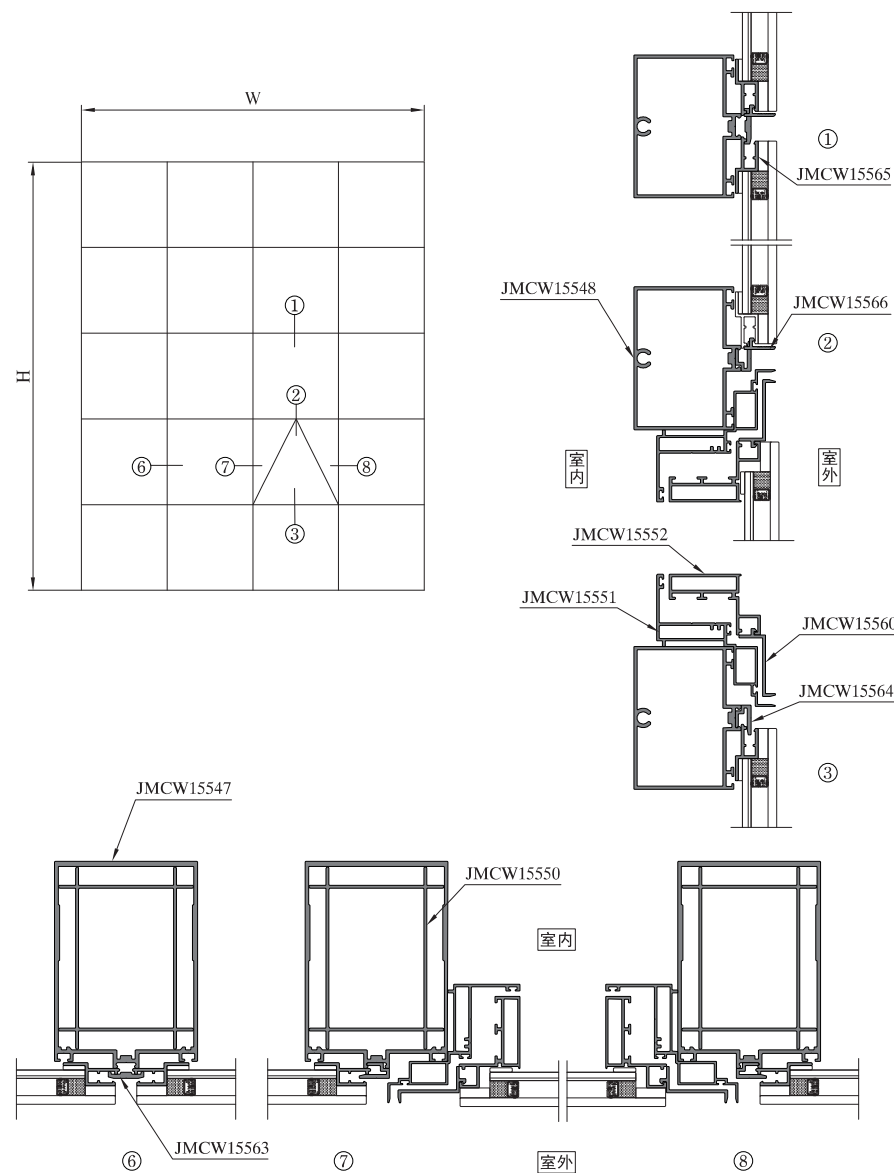

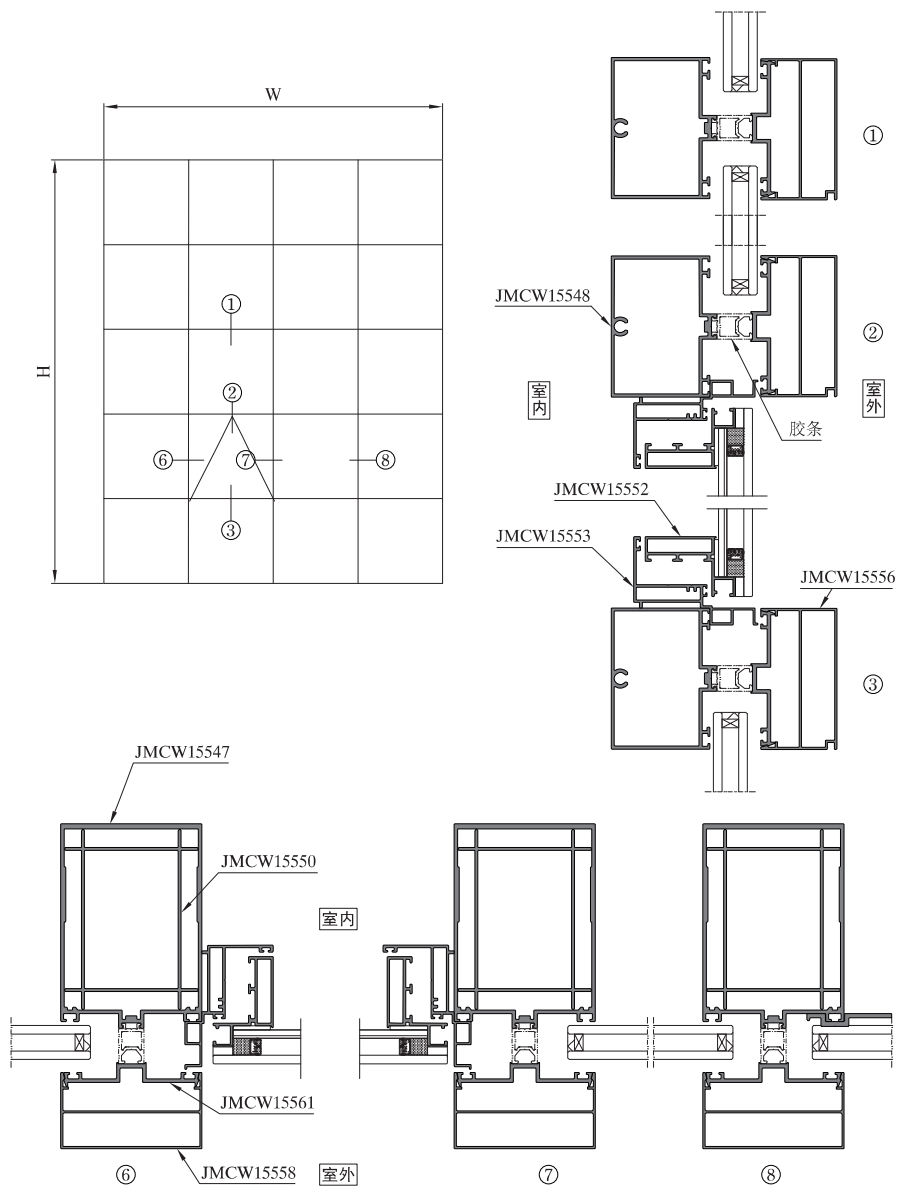

序号 S/N	型号理论重量 JMA Code & KG/M	型材图 Drawing	序号 S/N	型号理论重量 JMA Code & KG/M	型材图 Drawing	序号 S/N	型号理论重量 JMA Code & KG/M	型材图 Drawing
1	JMCW15547 4.297kg/m	套芯配JMCW15550 145 140 100	10	JMCW15554 0.442kg/m	底板配JMCW15562 70 20 1.2	19	JMCW15565 0.451kg/m	16 2 39.5
2	JMCW15550 2.547kg/m	127.5 2	11	JMCW15555 0.933kg/m	底板配JMCW15562 70 54 1.2	20	JMCW15566 0.165kg/m	8 2 22
3	JMCW15549 2.235kg/m	75 70 2.2	12	JMCW15561 1.043kg/m	95.74 17	21	JMCW15567 0.828kg/m	29 2 45
4	JMCW15548 2.621kg/m	75 70 2.2 100	13	JMCW15558 1.388kg/m	底板配JMCW15561 100 54 1.5	22	JMCW15568 0.662kg/m	8 60
5	JMCW15551 1.434kg/m	角码配JM3824 92.5 9.2 1.8 83	14	JMCW15556 1.414kg/m	底板配JMCW15561 100 54 1.5	23	JMCW15569 0.376kg/m	12.5 35.5
6	JMCW15553 1.284kg/m	角码配JM3824 62.5 9.2 1.8 88	15	JMCW15559 1.463kg/m	底板配JMCW15561 100 54 1.5	24		
7	JMCW15552 1.037kg/m	角码配Y14524 42.5 64 9.6	16	JMCW15557 2.278kg/m	底板配JMCW15561 94 100 2	25		
8	JMCW15560 0.417kg/m	47.5 25.5 2	17	JMCW15563 0.258kg/m	25 5 8	26		
9	JMCW15562 0.833kg/m	65.7 19.7 2.5	18	JMCW15564 0.291kg/m	11 2 21	27		

图中所示型材截面、装配、编号、尺寸及重量仅供参考。如有疑问，请向本公司查询。
Information above just for your reference. Please contact us if you have any questions, Thank you!

图中所示型材截面、装配、编号、尺寸及重量仅供参考。如有疑问，请向本公司查询。
Information above just for your reference. Please contact us if you have any questions, Thank you!

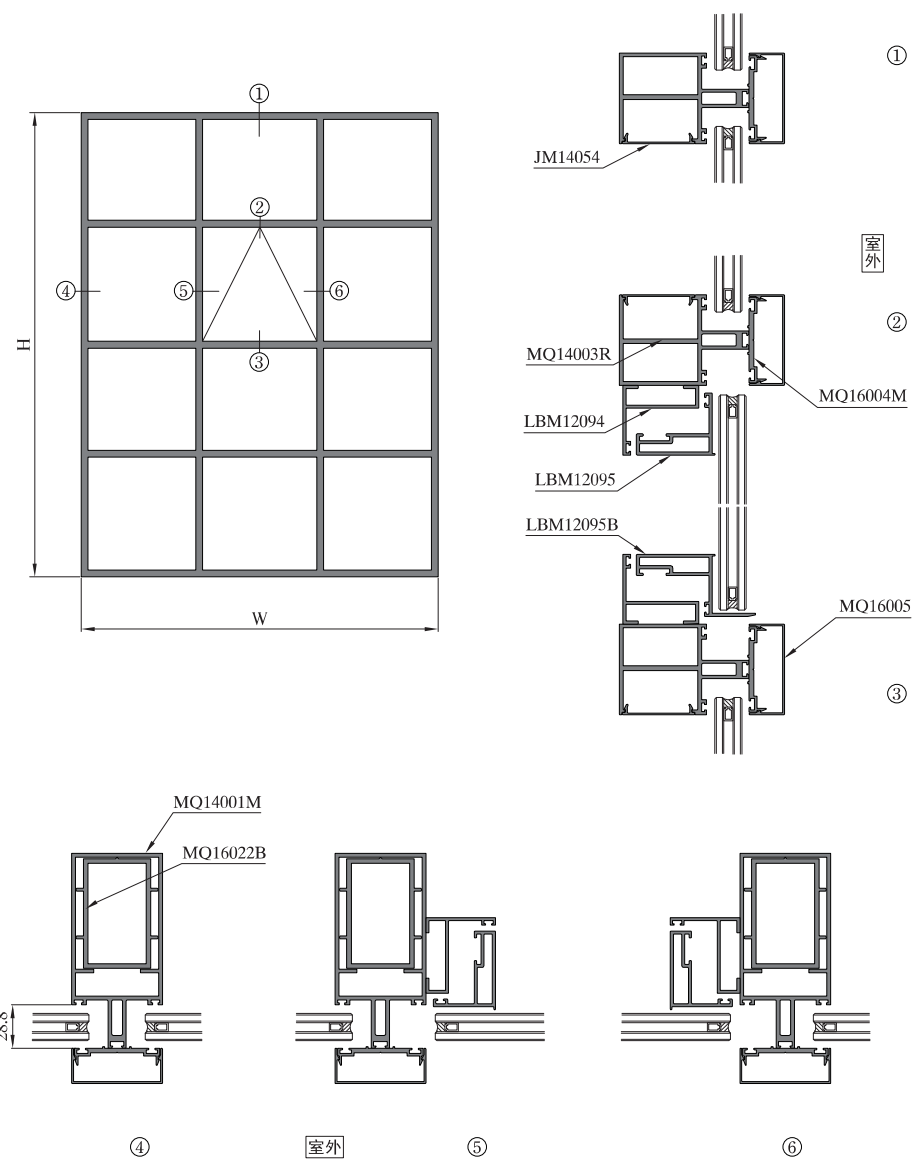
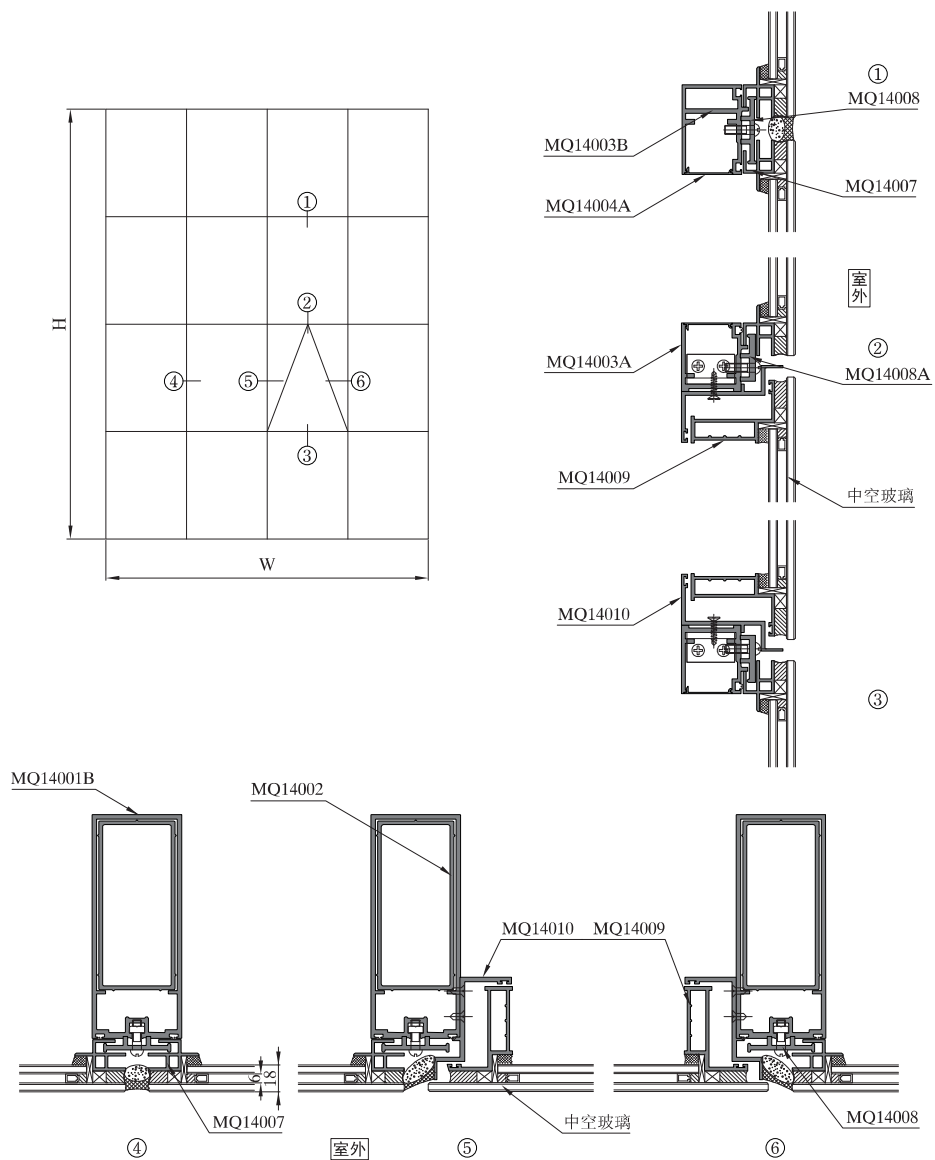

序号 S/N	型号理论重量 JMA Code & KG/M	型材图 Drawing	序号 S/N	型号理论重量 JMA Code & KG/M	型材图 Drawing	序号 S/N	型号理论重量 JMA Code & KG/M	型材图 Drawing
1	MQ14001 3.939kg/m	套芯配MQ14002 140	10	MQ14001Q 4.483kg/m	套芯配JMGR0161 60 180	19	MQ14003B 1.666kg/m	盖板配MQ14004A 44.5
2	MQ14001A 4.355kg/m	套芯配MQ14002 60 160	11	MQ14001R 4.521kg/m	套芯配JM11062A 176.87	20	MQ14003D 1.674kg/m	盖板配MQ14004A 40
3	MQ14001B 3.981kg/m	套芯配MQ14002 150	12	MQ14002 2.812kg/m	115.5 53.5	21	MQ14003E 2.176kg/m	盖板配MQ16006 62
4	MQ14001J 3.024kg/m	141	13	MQ14002C 2.804kg/m	114.5 31.75 3.5	22	MQ14003F 3.572kg/m	盖板配MQ14004 120
5	MQ14001K 3.448kg/m	套芯配MQ14002C 150	14	MQ14002F 2.567kg/m	53.5 101.5	23	MQ14003Q 1.703kg/m	盖板配MQ14004 70
6	MQ14001L 2.772kg/m	套芯配MQ16022B 60 100 115	15	MQ16022B 2.063kg/m	73.5 54.3	24	MQ14003R 2.257kg/m	盖板配JM14054 85.74
7	MQ14001M 3.023kg/m	套芯配MQ16022B 60 100 128.8	16	JMGR0161 3.269kg/m	140 53.5	25	MQ14003S 1.787kg/m	盖板配MQ14004A 57.5
8	MQ14001N 3.518kg/m	套芯配MQ14002F 125	17	MQ14003 2.885kg/m	70 104 70 4	26	MQ14003T 2.004kg/m	盖板配MQ14004 54.5
9	MQ14001P 3.957kg/m	套芯配MQ14002 150	18	MQ14003A 1.244kg/m	46 2.5 40	27	MQ14003W 2.264kg/m	盖板配JM13804E 75

序号 S/N	型号理论重量 JMA Code & KG/M	型材图 Drawing	序号 S/N	型号理论重量 JMA Code & KG/M	型材图 Drawing	序号 S/N	型号理论重量 JMA Code & KG/M	型材图 Drawing
28	MQ14004 0.238kg/m	4.45 1.2 62.1	37	MQ14007N 0.246kg/m	18.73 19 2 11.75	46	LBM12095B 1.108kg/m	角配码GRQ5509 78.5
29	MQ14004A 0.117kg/m	5 1 32.3	38	MQ14007P 0.368kg/m	18.75 2 37	47		
30	JM14054 0.219kg/m	7 1.2 47.8	39	MQ14008 0.530kg/m	45 3 10.5	48		
31	MQ14005 0.554kg/m	2.5 56.6 11.5	40	MQ14008A 0.482kg/m	31.5 4 10	49		
32	MQ16004M 0.542kg/m	56.4 12.32 3	41	MQ14009 0.976kg/m	角配码JM3824 42 2 56 9	50		
33	MQ14006 1.213kg/m	底板配MQ14005 80 1.5 60	42	MQ14010 0.859kg/m	34 2.5 51.5 68	51		
34	MQ16005 0.384kg/m	底板配MQ16004M 60 2.3.3 1.2	43	LBM12094 0.752kg/m	46 2 50	52		
35	MQ14007 0.549kg/m	34 2 21	44	LBM12094A 0.868kg/m	72 55 2	53		
36	MQ14007E 0.364kg/m	22.5 2 18 19	45	LBM12095 0.948kg/m	角配码GRQ5509 41 2 52	54		

图中所示型材截面、装配、编号、尺寸及重量仅供参考。如有疑问，请向本公司查询。
 Information above just for your reference. Please contact us if you have any questions, Thank you!

图中所示型材截面、装配、编号、尺寸及重量仅供参考。如有疑问，请向本公司查询。
 Information above just for your reference. Please contact us if you have any questions, Thank you!

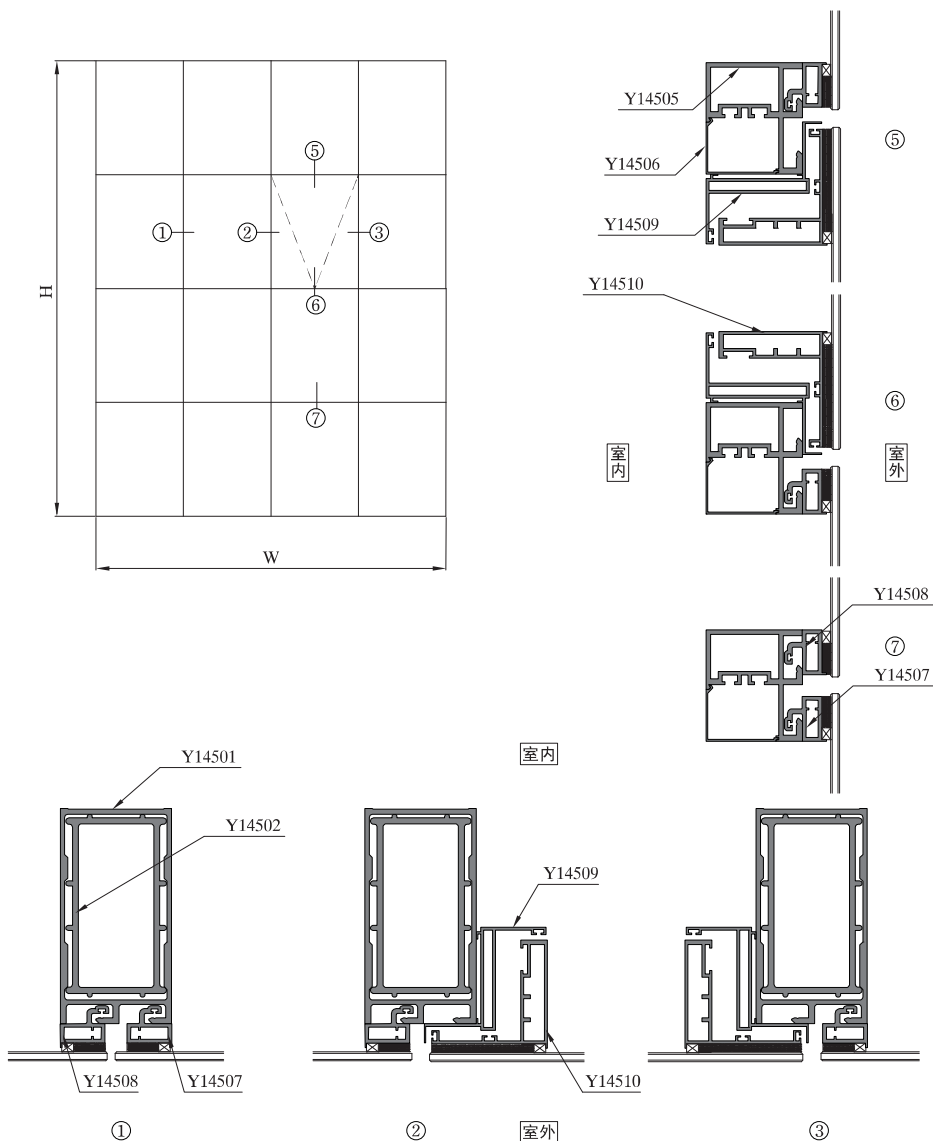

序号 S/N	型号理论重量 JMA Code & KG/M	型材图 Drawing	序号 S/N	型号理论重量 JMA Code & KG/M	型材图 Drawing	序号 S/N	型号理论重量 JMA Code & KG/M	型材图 Drawing
1	Y14501 4.895kg/m	套芯配Y14502 145	10	Y14515 1.947kg/m	角码配Y14524 78, 2, 104, 9.5	19	Y14518 0.742kg/m	52, 30, 1.5
2	Y14503 3.941kg/m	套芯配Y14504 145, 39.5	11	Y14516 1.927kg/m	65, 39.5	20	Y14519 0.742kg/m	32.5, 52, 1.2
3	Y14501B 5.878kg/m	套芯配Y14502 75, 3, 169.12, 90°, 93.38	12	Y14507 0.780kg/m	2.5, 28, 30	21	Y14521 0.607kg/m	32.5, 54, 2
4	Y14502 4.379kg/m	4, 123, 67.5	13	Y14508 0.780kg/m	28, 2, 32.5	22	Y14521A 0.566kg/m	32.5, 47, 2
5	Y14504 3.510kg/m	123, 32, 4	14	Y14511 0.637kg/m	46, 30, 2	23	Y14522 0.607kg/m	54, 30, 2
6	Y14505 2.711kg/m	75, 65, 3	15	Y14512 0.635kg/m	46, 32.5, 2	24	Y14522A 0.566kg/m	47, 30, 2
7	Y14506 0.314kg/m	48.7, 1.2, 37.8	16	Y14513 1.133kg/m	59, 2.5, 32.5	25	Y14520 0.582kg/m	16, 30, 2.5
8	Y14509 1.399kg/m	角码配Y14523 2, 6, 82, 69.5	17	Y14514 1.133kg/m	59, 30, 2	26	Y14523 0.948kg/m	与Y14509配合 42, 42, 5.8
9	Y14510 1.594kg/m	角码配Y14524 78, 73, 9.5	18	Y14517 0.584kg/m	角码配Y14524 3, 57, 12.5	27	Y14524 1.408kg/m	与Y14510配合 40, 40, 9.3

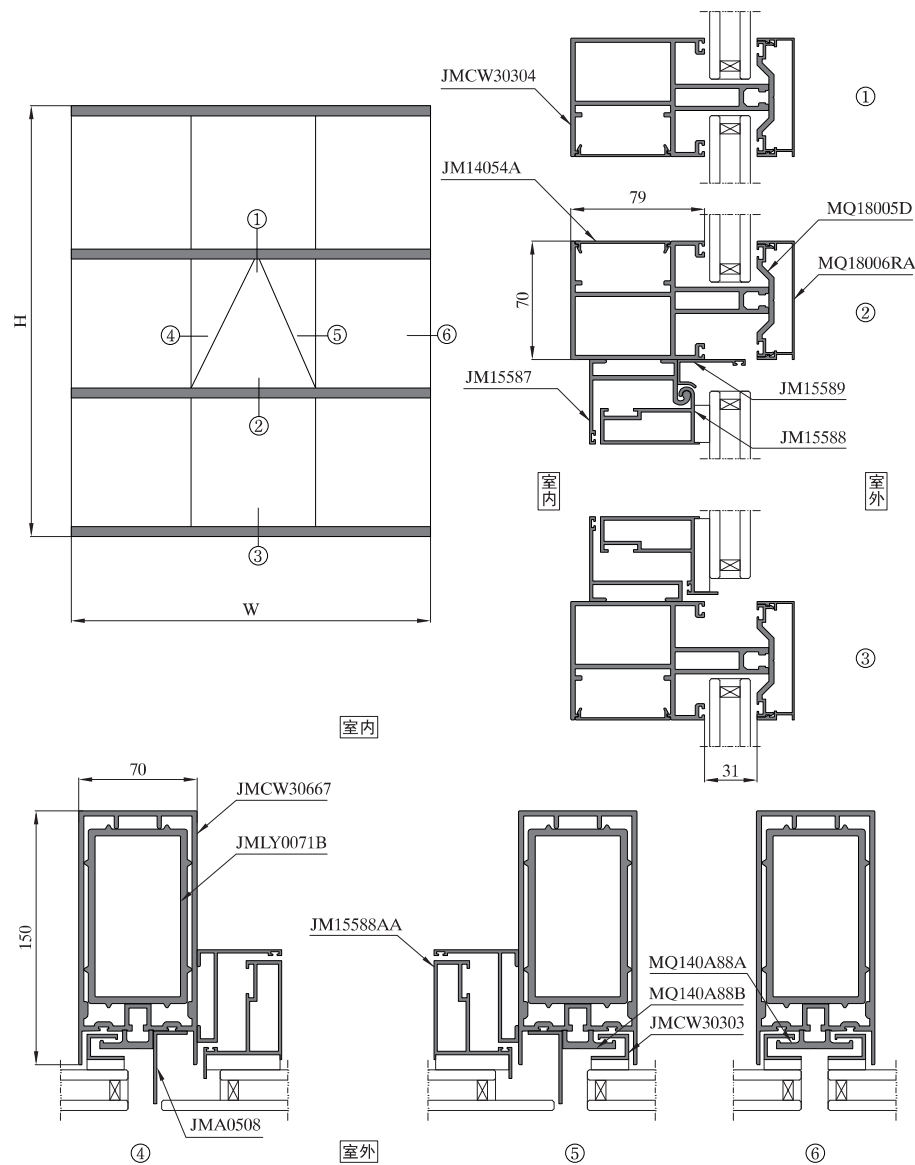

序号 S/N	型号理论重量 JMA Code & KG/M	型材图 Drawing	序号 S/N	型号理论重量 JMA Code & KG/M	型材图 Drawing	序号 S/N	型号理论重量 JMA Code & KG/M	型材图 Drawing
1	主梁 JMCW30301 5.807kg/m	套芯MQ18002 	10	横梁盖板 MQ16006 0.200kg/m	横梁配JMCW30308 	19	压块 MQ140A88A 0.612kg/m	
2	主梁 JMCW30667 4.158kg/m	套芯JMLY0071B 	11	横梁盖板 JM14054A 0.249kg/m		20	压块 MQ140A88B 0.463kg/m	
3	主梁 JMCW30668 3.030kg/m		12	玻璃框 JMCW30303 0.301kg/m		21	封边 JMCW30673 0.403kg/m	
4	套芯 MQ18002 3.392kg/m		13	底板 MQ18005 0.632kg/m		22	封边 JMCW30311 0.396kg/m	
5	套芯 JMLY0071B 3.739kg/m		14	底板 MQ18005D 0.665kg/m		23	开启框 JM15587 1.023kg/m	
6	横梁 JMCW30308 2.319kg/m	横梁盖板配MQ16006 	15	装饰盖 MQ18006R 0.480kg/m		24	开启框 JM15587A 0.760kg/m	
7	横梁 JMCW30304 3.258kg/m	横梁盖板配JM14054A 	16	装饰盖 MQ18006RA 0.449kg/m		25	开启扇 JM15588 1.025kg/m	角码JM5004A
8	横梁 JMCW30671 4.181kg/m	横梁盖板配JM13804 	17	装饰盖 MQ18006N 0.544kg/m		26	开启扇 JM15588D 1.080kg/m	角码JM5004A
9	横梁盖板 JM13804 0.338kg/m	横梁配JMCW30671 	18	玻璃封边 JMCW30307 0.330kg/m		27	开启扇 JM15588AA 1.146kg/m	角码JM5004A

图中所示型材截面、装配、编号、尺寸及重量仅供参考。如有疑问，请向本公司查询。
Information above just for your reference. Please contact us if you have any questions, Thank you!

图中所示型材截面、装配、编号、尺寸及重量仅供参考。如有疑问，请向本公司查询。
Information above just for your reference. Please contact us if you have any questions, Thank you!

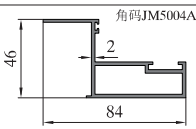
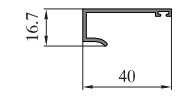
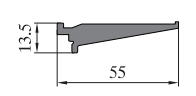
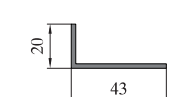
序号 S/N	型号理论重量 JMA Code & KG/M	型材图 Drawing	序号 S/N	型号理论重量 JMA Code & KG/M	型材图 Drawing	序号 S/N	型号理论重量 JMA Code & KG/M	型材图 Drawing
28	开启扇 JM15588A 1.213kg/m		37	46				
29	封边 JM15589 0.288kg/m		38	47				
30	托片 JMCW30672 0.955kg/m		39	48				
31	铝角 JMA0508 0.357kg/m		40	49				
32			41	50				
33			42	51				
34			43	52				
35			44	53				
36			45	54				

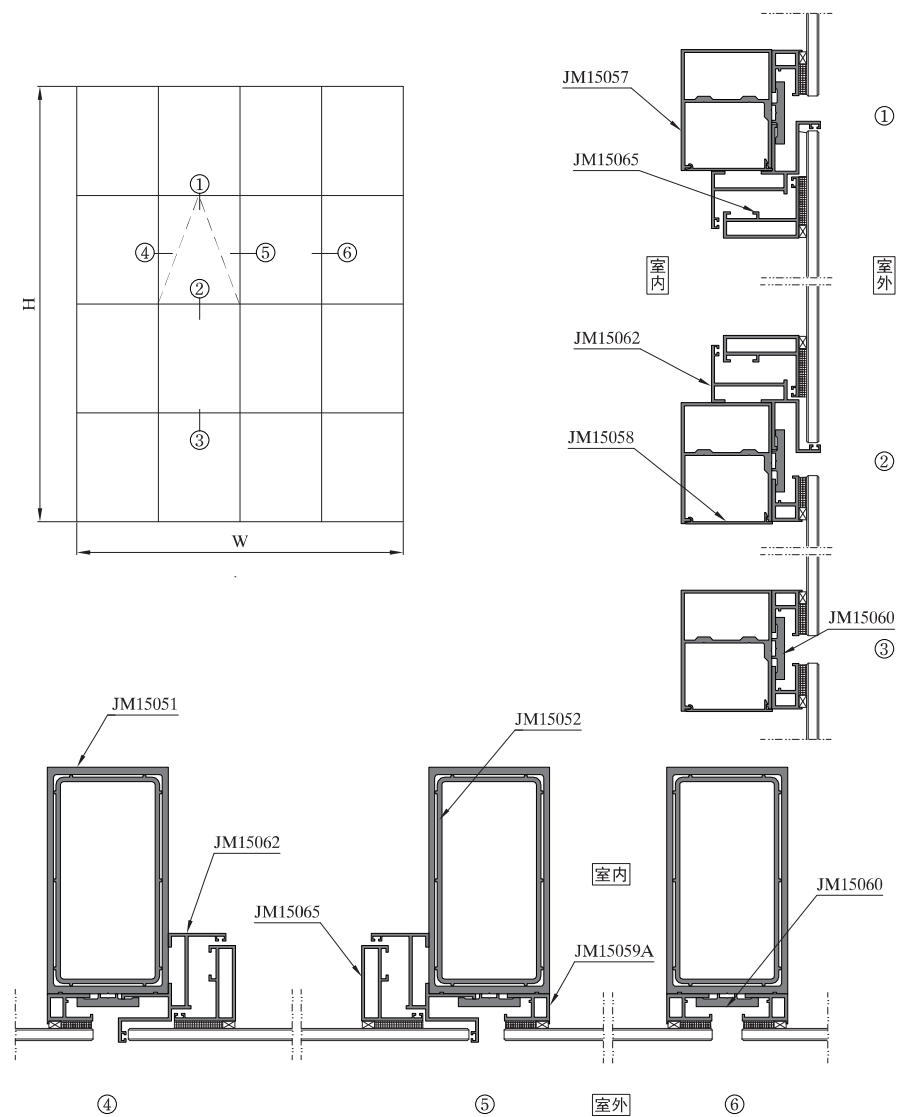

序号 S/N	型号理论重量 JMA Code & KG/M	型材图 Drawing	序号 S/N	型号理论重量 JMA Code & KG/M	型材图 Drawing	序号 S/N	型号理论重量 JMA Code & KG/M	型材图 Drawing
1	JM15051 5.614kg/m	套芯配JM15052 	10	JM15056 0.826kg/m		19	JM15066 1.194kg/m	
2	JM15052 3.527kg/m		11	JM15059 0.582kg/m		20	JM15067 0.179kg/m	
3	JM15053 2.884kg/m		12	JM15059A 0.597kg/m		21	JM3824 1.331kg/m	
4	JM15053A 3.103kg/m		13	JM15060 0.687kg/m		22		
5	JM15054 1.747kg/m		14	JM15061 1.246kg/m		23		
6	JM15054A 1.967kg/m		15	JM15062 1.273kg/m		24		
7	JM15057 1.932kg/m	盖板配JM15058 	16	JM15063 0.969kg/m		25		
8	JM15058 0.282kg/m		17	JM15064 0.863kg/m	角码配JM3824 	26		
9	JM15055 0.651kg/m		18	JM15065 0.946kg/m	角码配JM3824 	27		

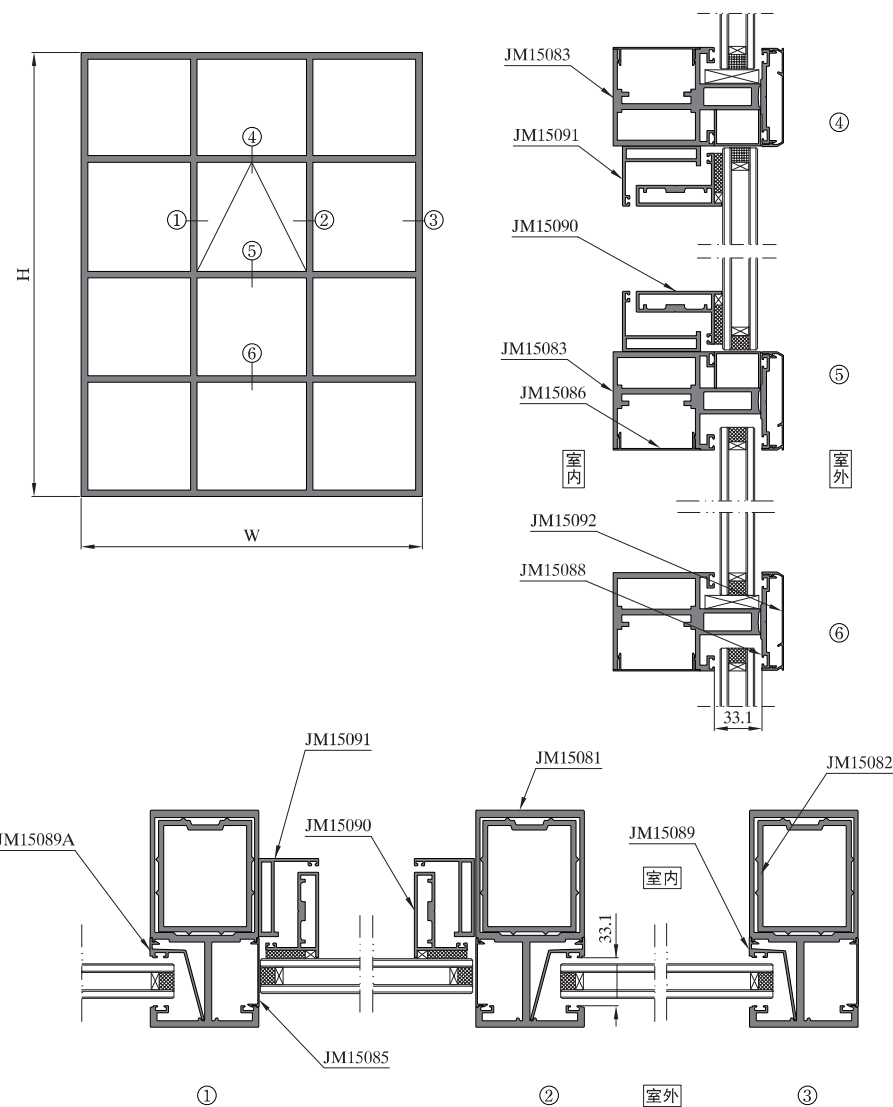

图中所示型材截面、装配、编号、尺寸及重量仅供参考。如有疑问，请向本公司查询。
Information above just for your reference. Please contact us if you have any questions, Thank you!

图中所示型材截面、装配、编号、尺寸及重量仅供参考。如有疑问，请向本公司查询。
Information above just for your reference. Please contact us if you have any questions, Thank you!

序号 S/N	型号理论重量 JMA Code & KG/M	型材图 Drawing	序号 S/N	型号理论重量 JMA Code & KG/M	型材图 Drawing	序号 S/N	型号理论重量 JMA Code & KG/M	型材图 Drawing
1	JM15081 5.707kg/m	套芯配JM15082 	10	JM15082A 4.157kg/m	底板配JM15088 	19	JM15092A 0.752kg/m	底板配JM15088
2	JM15081H 4.492kg/m	套芯配JM15082 	11	JM15083 3.975kg/m	盖板配JM15086 	20	JM15088 0.674kg/m	
3	JM15081A 4.425kg/m	套芯配JM15082A 	12	JM15083D 3.363kg/m	盖板配JM15086 	21	JM15086 0.245kg/m	
4	JM15081J 4.115kg/m	套芯配JM15082B 	13	JM15083E 2.846kg/m	盖板配JM15086 	22	JM15085 0.185kg/m	
5	JM15081M 4.004kg/m	套芯配JM15082D 	14	JM15083F 2.209kg/m		23	JM15091 0.978kg/m	角码配JM4026A
6	JM15081G 3.780kg/m		15	JM15083A 3.048kg/m	盖板配JM15086 	24	JM15090 1.097kg/m	角码配PC5026A
7	JM15081K 2.621kg/m	套芯配JM15082C 	16	JM15083B 3.048kg/m	盖板配JM15086 	25	JM15084 0.589kg/m	
8	JM14031 4.771kg/m	套芯配JM14032 	17	JM15083C 2.922kg/m	盖板配JM15086 	26	JM15084A 0.791kg/m	
9	JM15082 2.893kg/m		18	JM15092 0.326kg/m	底板配JM15088 	27	JM15087 0.620kg/m	

序号 S/N	型号理论重量 JMA Code & KG/M	型材图 Drawing	序号 S/N	型号理论重量 JMA Code & KG/M	型材图 Drawing	序号 S/N	型号理论重量 JMA Code & KG/M	型材图 Drawing
28	JM15087A 0.430kg/m		37			46		
29	JM15089 0.473kg/m	玻璃开口33mm 	38			47		
30	JM15089A 0.491kg/m	玻璃开口33mm 	39			48		
31	JM15089B 0.468kg/m	玻璃开口17.8mm 	40			49		
32	JM15089C 0.504kg/m	玻璃开口17.8mm 	41			50		
33	JM4026A66 0.935kg/m		42			51		
34	PC5026A 1.331kg/m		43			52		
35			44			53		
36			45			54		

图中所示型材截面、装配、编号、尺寸及重量仅供参考。如有疑问，请向本公司查询。
 Information above just for your reference. Please contact us if you have any questions, Thank you!

图中所示型材截面、装配、编号、尺寸及重量仅供参考。如有疑问，请向本公司查询。
 Information above just for your reference. Please contact us if you have any questions, Thank you!

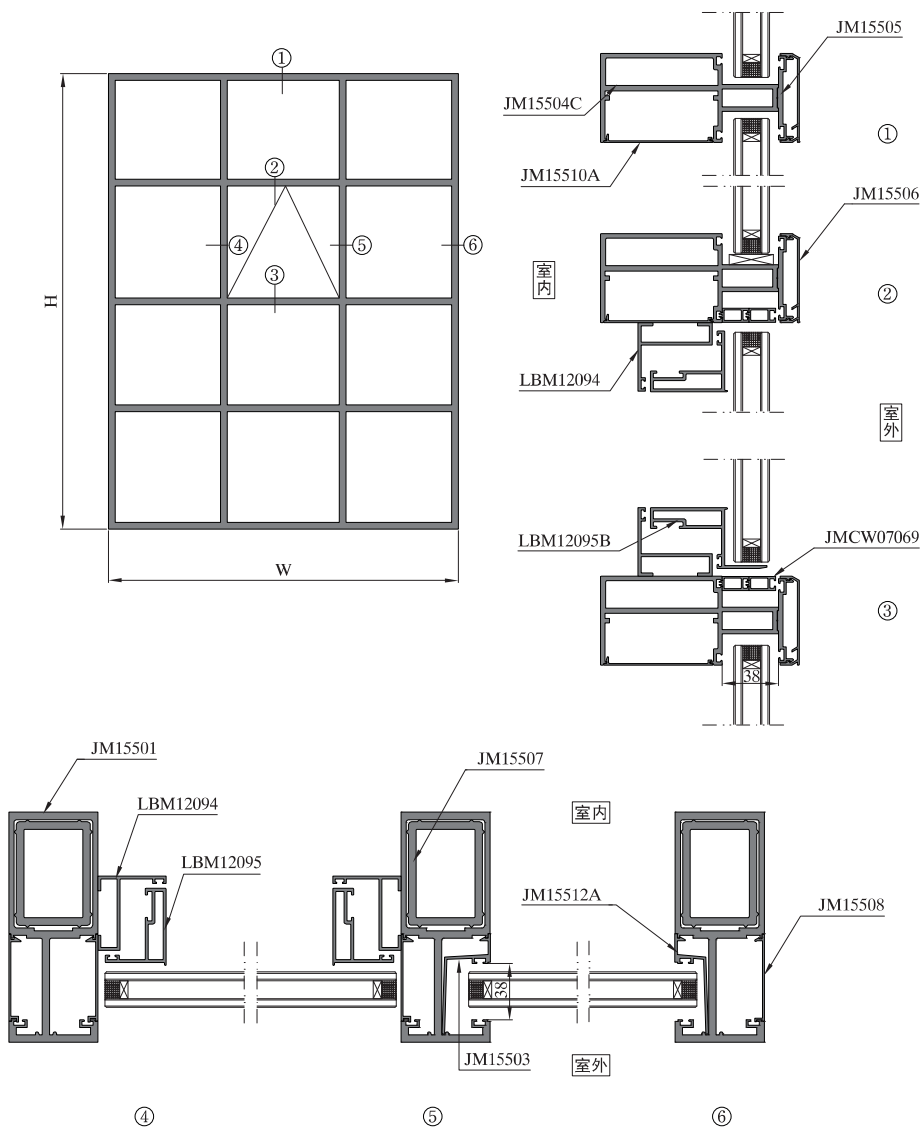

序号 S/N	型号 JMA Code & KG/M	型材图 Drawing	序号 S/N	型号 JMA Code & KG/M	型材图 Drawing	序号 S/N	型号 JMA Code & KG/M	型材图 Drawing
1	JM15501 5.549kg/m	套芯配JM15507 85 55 60 3.5 155	10	JM15504C 3.401kg/m	盖板配JM15510A 120 82 60	19	LBM12095 0.948kg/m	角码配GRO5509 41 2 10 52
2	JM15501A 5.390kg/m	100 55 60 3.5 170	11	JM15513 2.061kg/m	54 36 60	20	LBM12095B 1.108kg/m	角码配GRO5509 41 2 10 78.5
3	JM15507 3.250kg/m	52.8 5 72.7	12	JM15510 0.202kg/m	8.6 1 54.2	21	JMCW07069 0.203kg/m	18 1.2 9.5
4	JM15501B 8.394kg/m	155 55 155	13	JM15510A 0.285kg/m	5.7 1.2 73.6	22	JM15503 0.553kg/m	配JM15501 玻璃开口:38mm 67.6 47.6 32.47 1.6
5	JM15516A 6.371kg/m	套芯配JM15507 55 135° 60 3.5 158	14	JM15506 0.333kg/m	13 1.2 60	23	JM15511 0.541kg/m	配JM15501 玻璃开口:19mm 32.46 1.6 28.6 67.6
6	JM15516B 6.079kg/m	套芯配JM15507 3.5 55 135° 60 5 155	15	JM15506A 0.364kg/m	20 1.2 60	24	JM15512 0.498kg/m	配JM15501 玻璃开口:19mm 22.46 1.6 28.6 67.6
7	JM15504 2.731kg/m	55 17 60 4	16	JM15506B 0.433kg/m	24 1.2 60	25	JM15512A 0.495kg/m	配JM15501 玻璃开口:38mm 22.47 47.6 1.6 67.6
8	JM15504A 2.594kg/m	90 60 60	17	JM15505 0.562kg/m	10.8 56.4 60	26	JM15508 0.252kg/m	6.4 1.2 58.9
9	JM15504B 2.808kg/m	盖板配JM15510 77 60 59	18	LBM12094 0.752kg/m	46 2 50	27	GRO5509 2.690kg/m	60 9.7 60

图中所示型材截面、装配、编号、尺寸及重量仅供参考。如有疑问，请向本公司查询。
Information above just for your reference. Please contact us if you have any questions, Thank you!

图中所示型材截面、装配、编号、尺寸及重量仅供参考。如有疑问，请向本公司查询。
Information above just for your reference. Please contact us if you have any questions, Thank you!

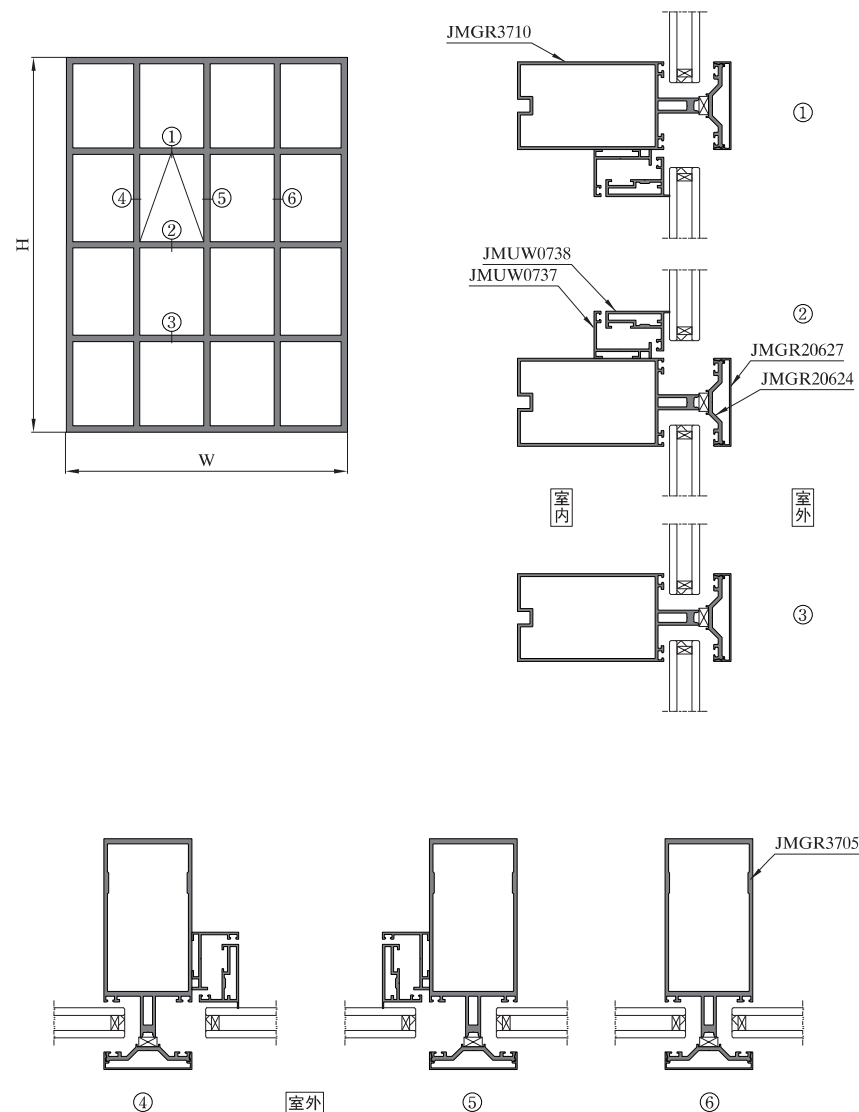
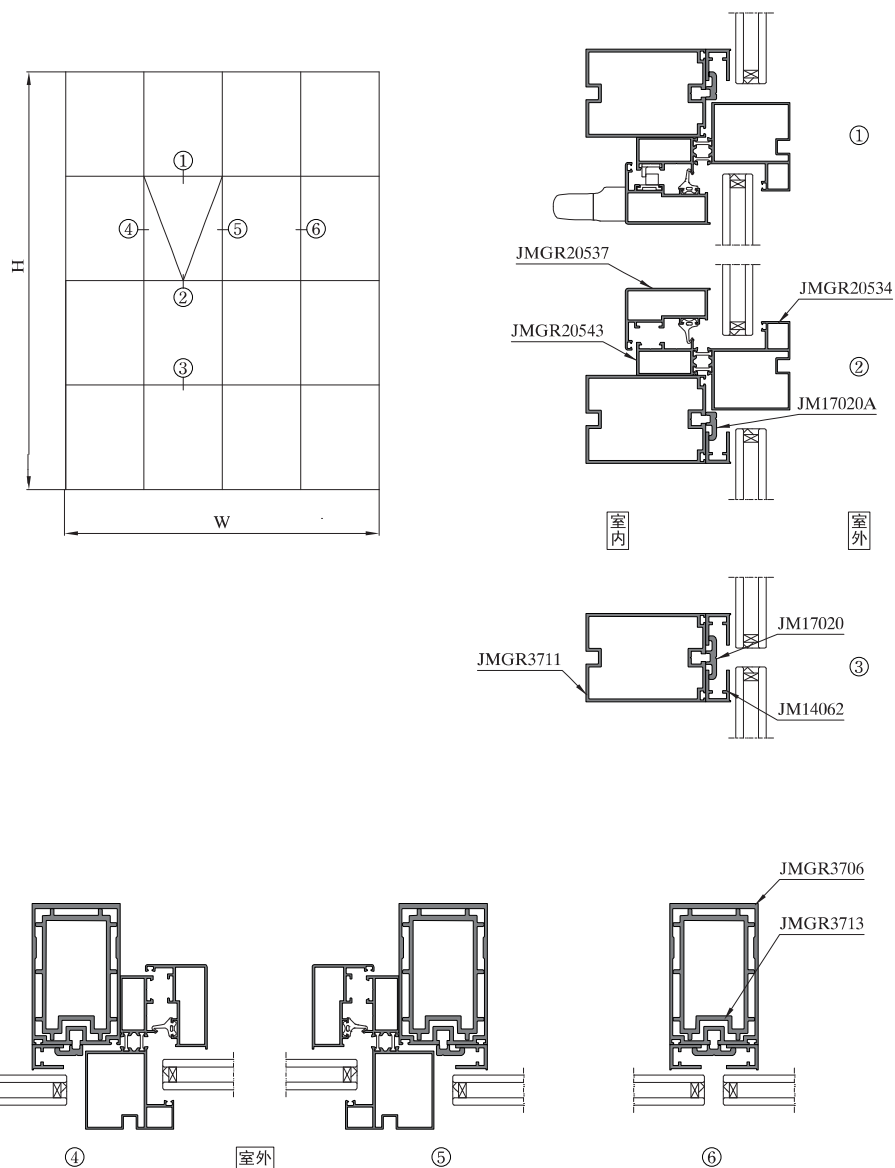

序号 S/N	型号理论重量 JMA Code & KG/M	型材图 Drawing	序号 S/N	型号理论重量 JMA Code & KG/M	型材图 Drawing	序号 S/N	型号理论重量 JMA Code & KG/M	型材图 Drawing
1	JMGR3705 4.360kg/m		10	JMGR20624 0.778kg/m		19	JM17020A 0.337kg/m	
2	JMGR3706 3.270kg/m	芯芯配JMGR3713 	11	JMGR20627 0.366kg/m		20	JM14062 0.507kg/m	
3	JMGR3708 3.402kg/m		12	JMUW0737 0.631kg/m		21	JMGR20103 0.848kg/m	
4	JMGR3709 2.783kg/m		13	JMUW0738 0.900kg/m	角码配CKZA0010 	22	JMGR20104 1.123kg/m	
5	JMGR3710 3.219kg/m		14	JMGR20534 JMGR20543 2.471kg/m		23	JMGR20105 1.167kg/m	
6	JMGR3711 2.551kg/m		15	JMGR20535 JMGR20543 1.836kg/m		24	JMGR3707A JMGR3707B 5.303kg/m	芯芯配JMGR3714
7	JMCW09798 3.635kg/m		16	JMGR20536 JMGR20543 1.758kg/m		25	JM261730 1.044kg/m	
8	JMGR3713 3.349kg/m		17	JMGR20537 1.324kg/m	角码配JMGR5008 	26	JMGR3712 0.153kg/m	
9	JMGR3714 2.742kg/m		18	JM17020 0.483kg/m		27	JMGR3715 0.984kg/m	

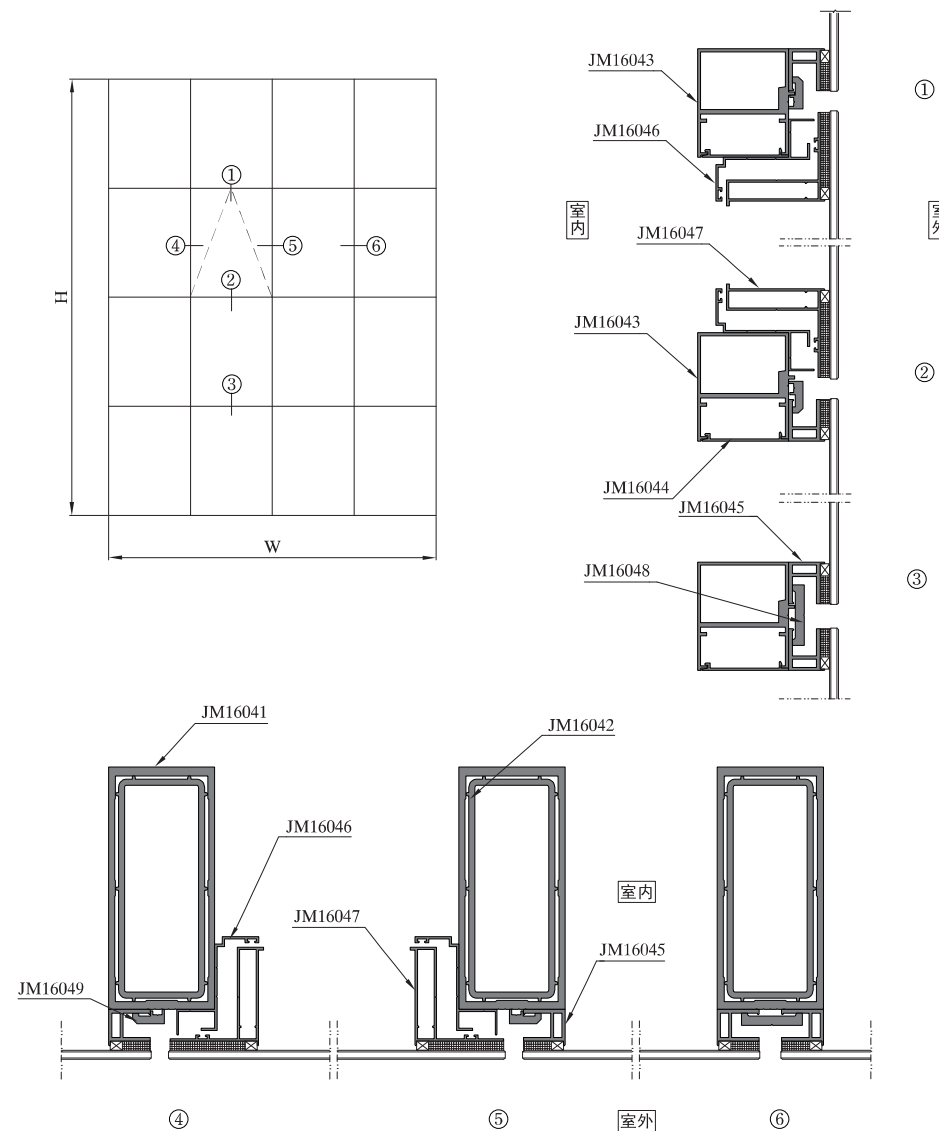

图中所示型材截面、装配、编号、尺寸及重量仅供参考。如有疑问，请向本公司查询。
Information above just for your reference. Please contact us if you have any questions, Thank you!

图中所示型材截面、装配、编号、尺寸及重量仅供参考。如有疑问，请向本公司查询。
Information above just for your reference. Please contact us if you have any questions, Thank you!

序号 S/N	型号理论重量 JMA Code & KG/M	型材图 Drawing	序号 S/N	型号理论重量 JMA Code & KG/M	型材图 Drawing	序号 S/N	型号理论重量 JMA Code & KG/M	型材图 Drawing
1	JM16041 5.923kg/m	套芯配JM16042 	10	JM16046 0.613kg/m		19		
2	JM16041A 2.985kg/m	套芯配JM16042A 	11	JM16047 0.896kg/m	角码JM16054 	20		
3	JM16042 4.563kg/m		12	JM16048 0.752kg/m		21		
4	JM16042A 2.989kg/m		13	JM16049 0.369kg/m		22		
5	JM16043A 1.844kg/m	盖板配JM16044 	14	JM16050 0.685kg/m		23		
6	JM16043B 1.783kg/m	盖板配JM16044 	15	JM16051 1.379kg/m		24		
7	JM16043C 2.020kg/m	盖板配JM16044 	16	JM16052 0.718kg/m		25		
8	JM16043 1.943kg/m	盖板配JM16044 	17	JM16053 1.132kg/m		26		
9	JM16044 0.287kg/m		18	JM16045 0.600kg/m		27		

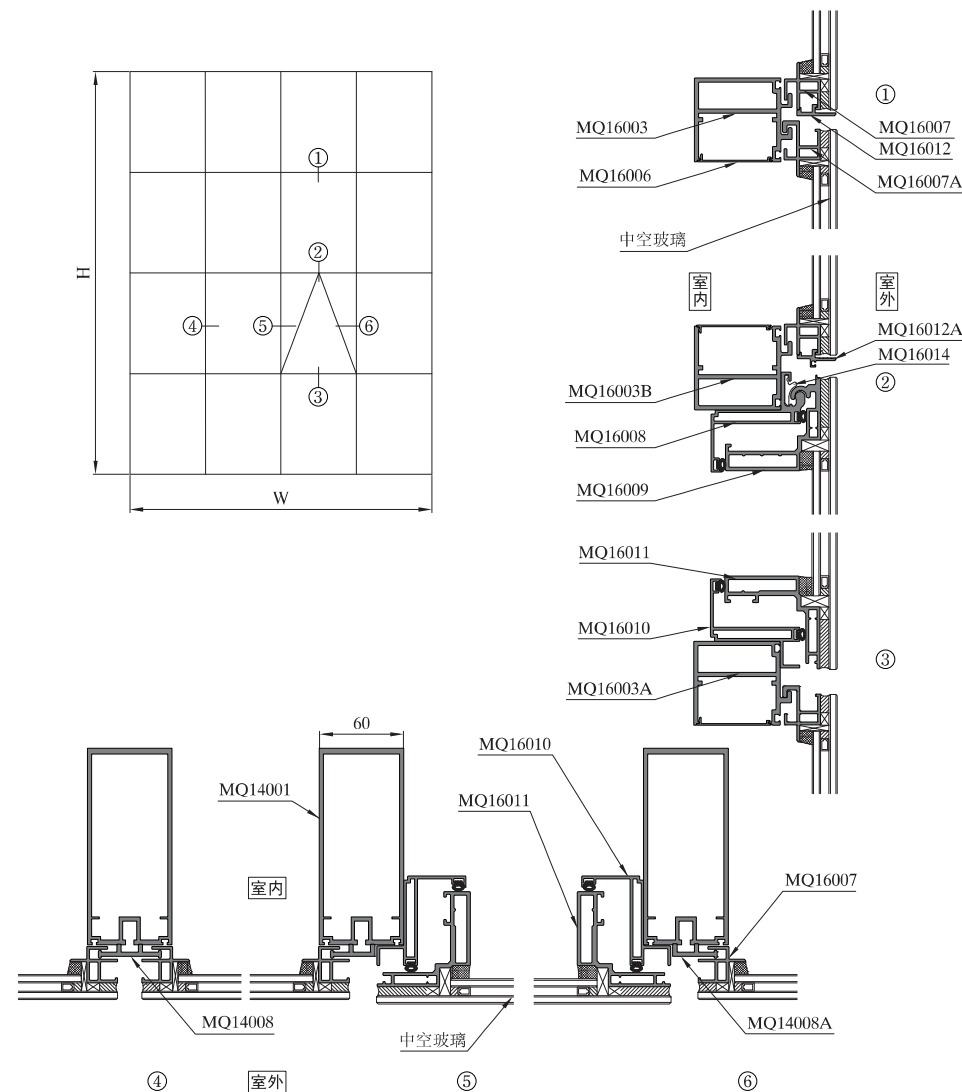





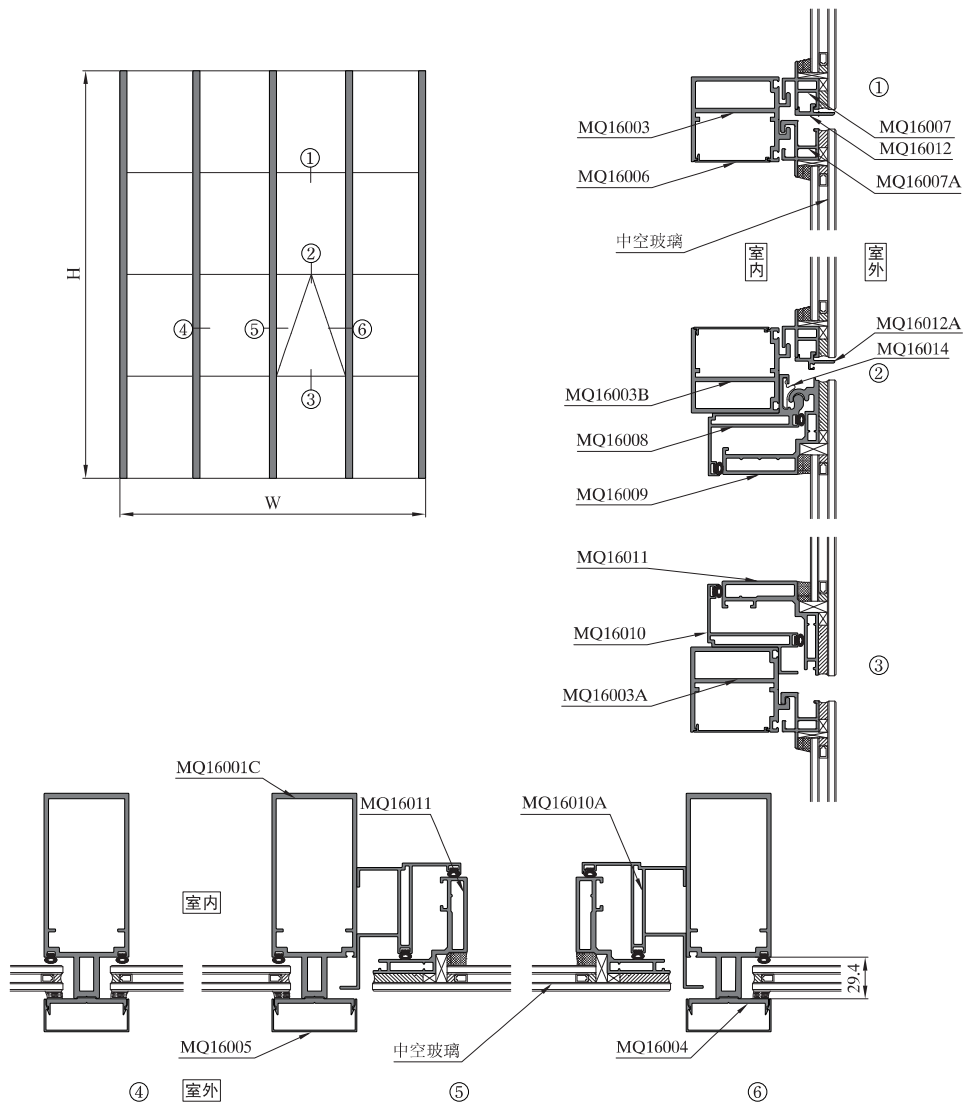

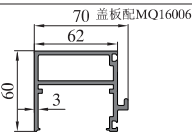
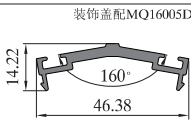
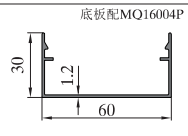
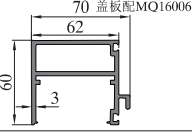
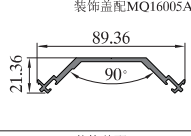
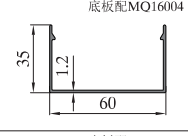
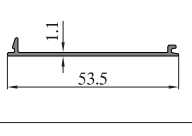
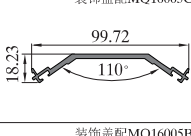
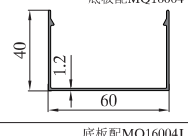
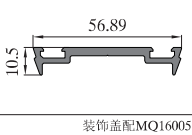
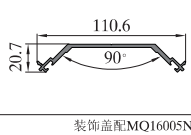
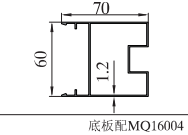
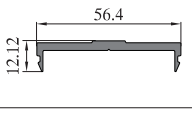
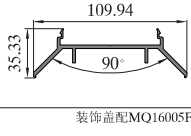
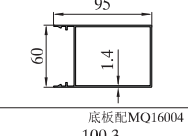
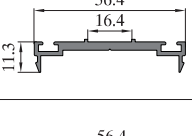
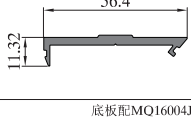
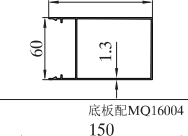
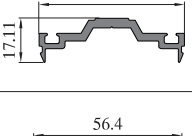
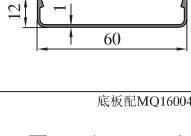
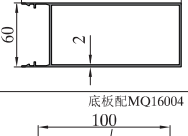
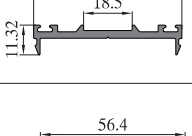
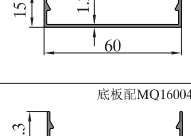
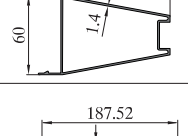

图中所示型材截面、装配、编号、尺寸及重量仅供参考。如有疑问，请向本公司查询。
Information above just for your reference. Please contact us if you have any questions, Thank you!

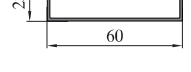
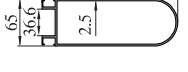
图中所示型材截面、装配、编号、尺寸及重量仅供参考。如有疑问，请向本公司查询。
Information above just for your reference. Please contact us if you have any questions, Thank you!

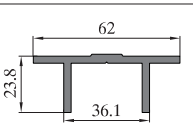
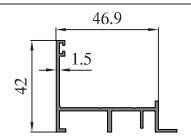
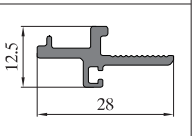
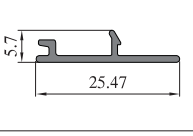
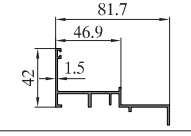
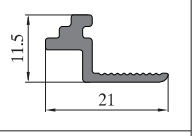
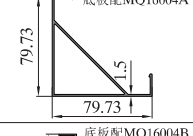
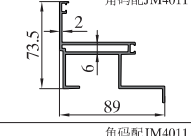
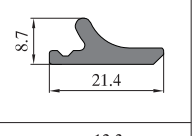
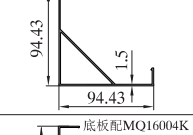
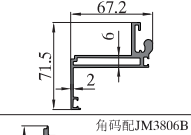
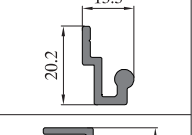
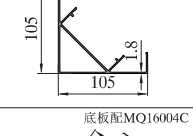
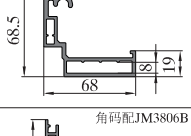
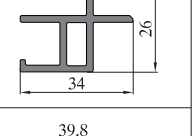

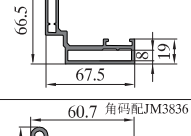
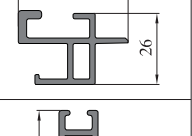
序号 S/N	型号理论重量 JMA Code & KG/M	型材图 Drawing	序号 S/N	型号理论重量 JMA Code & KG/M	型材图 Drawing	序号 S/N	型号理论重量 JMA Code & KG/M	型材图 Drawing
1	MQ16001T 1.848kg/m		10	MQ16001B 4.282kg/m	套芯配MQ16002A 	19	MQ16002C 2.575kg/m	
2	MQ16001W 2.601kg/m		11	MQ16001ZA 1.324kg/m		20	MQ16002B 3.160kg/m	
3	MQ16001H 3.668kg/m	套芯配MQ16002C 	12	MQ16001J 4.228kg/m 套芯配MQ16002C 扣盖配MQ16004B MQ16005B		21	MQ16002D 3.467kg/m	
4	MQ16001C 4.106kg/m	套芯配MQ16002B 	13	MQ16001D 4.668kg/m 套芯配MQ16002B 扣盖配MQ16004B MQ16005B		22	MQ16003C 2.492kg/m	盖板配MQ16006
5	MQ16001CA 3.485kg/m	套芯配MQ16002B 	14	MQ16001E 4.487kg/m 套芯配MQ16002B 扣盖配MQ16004C MQ16005C		23	MQ16003F 2.030kg/m	盖板配MQ16006
6	MQ16001Z 3.384kg/m	套芯配MQ14002F 	15	MQ16001A 4.667kg/m 套芯配MQ16002A 扣盖配MQ16004A MQ16005A		24	MQ16003D 2.754kg/m	盖板配MQ16006
7	MQ16001S 4.546kg/m	套芯配MQ16002A 	16	MQ16001G 3.992kg/m 套芯配MQ16002B 扣盖配MQ16004D MQ16005D		25	MQ16003L 2.541kg/m	盖板配MQ16006
8	MQ16001L 5.303kg/m	套芯配MQ16002D 	17	MQ16001F 4.201kg/m	套芯配MQ16002B 	26	MQ16003E 4.112kg/m	盖板配MQ16006
9	MQ16001BA 4.071kg/m	套芯配MQ16002A 	18	MQ16002A 3.862kg/m		27	MQ16003 2.386kg/m	盖板配MQ16006

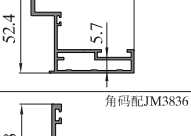
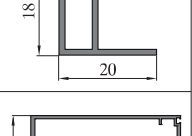
序号 S/N	型号理论重量 JMA Code & KG/M	型材图 Drawing	序号 S/N	型号理论重量 JMA Code & KG/M	型材图 Drawing	序号 S/N	型号理论重量 JMA Code & KG/M	型材图 Drawing
28	MQ16003A 2.270kg/m	70 盖板配MQ16006 	37	MQ16004D 0.451kg/m	装饰盖配MQ16005D 	46	MQ16005Z 0.459kg/m	底板配MQ16004P 
29	MQ16003B 2.260kg/m	70 盖板配MQ16006 	38	MQ16004A 0.837kg/m	装饰盖配MQ16005A 	47	MQ16005E 0.467kg/m	底板配MQ16004 
30	MQ16006 0.200kg/m		39	MQ16004C 0.949kg/m	装饰盖配MQ16005C 	48	MQ16005G 0.501kg/m	底板配MQ16004 
31	MQ16004J 0.584kg/m		40	MQ16004B 0.969kg/m	装饰盖配MQ16005B 	49	MQ16005T 1.047kg/m	底板配MQ16004J 
32	MQ16004 0.599kg/m	装饰盖配MQ16005 	41	MQ16004K 1.203kg/m	装饰盖配MQ16005N 	50	MQ16005Q 1.270kg/m	底板配MQ16004 
33	MQ16004M 0.542kg/m		42	MQ16004E 0.582kg/m	装饰盖配MQ16005F 	51	MQ16005QA 1.229kg/m	底板配MQ16004 
34	MQ16004R 0.664kg/m		43	MQ16005M 0.254kg/m	底板配MQ16004J 	52	MQ16005QB 2.340kg/m	底板配MQ16004 
35	MQ16004S 0.576kg/m		44	MQ16005V 0.326kg/m	底板配MQ16004 	53	MQ16005X 1.242kg/m	底板配MQ16004 
36	MQ16004P 0.635kg/m		45	MQ16005 0.384kg/m	底板配MQ16004 	54	MQ16005R 3.597kg/m	

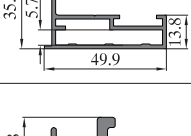
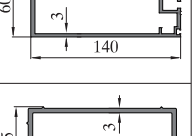
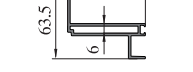
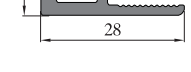
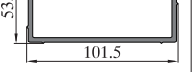
序号 S/N	型号理论重量 JMA Code & KG/M	型材图 Drawing	序号 S/N	型号理论重量 JMA Code & KG/M	型材图 Drawing	序号 S/N	型号理论重量 JMA Code & KG/M	型材图 Drawing
55	MQ16004L 0.940kg/m		64	MQ16010B 0.591kg/m		73	MQ16012A 0.245kg/m	
56	MQ16006A 0.120kg/m		65	MQ16010C 0.784kg/m		74	MQ16013 0.167kg/m	
57	MQ16005A 1.209kg/m	底板配MQ16004A 	66	MQ16010A 1.750kg/m	角码配JM4011 	75	MQ16014 0.235kg/m	
58	MQ16005B 1.247kg/m	底板配MQ16004B 	67	MQ16008 1.614kg/m	角码配JM4011 	76	MQ16014A 0.247kg/m	
59	MQ16005N 2.015kg/m	底板配MQ16004K 	68	MQ16009 1.935kg/m	角码配JM3806B 	77	MQ16007 0.616kg/m	
60	MQ16005C 1.098kg/m	底板配MQ16004C 	69	MQ16011 1.785kg/m	角码配JM3806B 	78	MQ16007A 0.745kg/m	
61	MQ16005D 0.388kg/m	底板配MQ16004D 	70	MQ16009C 0.999kg/m	角码配JM3836 	79	MQ16007B 0.214kg/m	
62	MQ16005F 0.449kg/m	底板配MQ16004E 	71	MQ16009D 0.753kg/m	角码配JM3836 	80	MQ14001 3.939kg/m	
63	MQ16010 1.234kg/m	角码配JM4011 	72	MQ16012 0.235kg/m		81	MQ14002F 2.567kg/m	

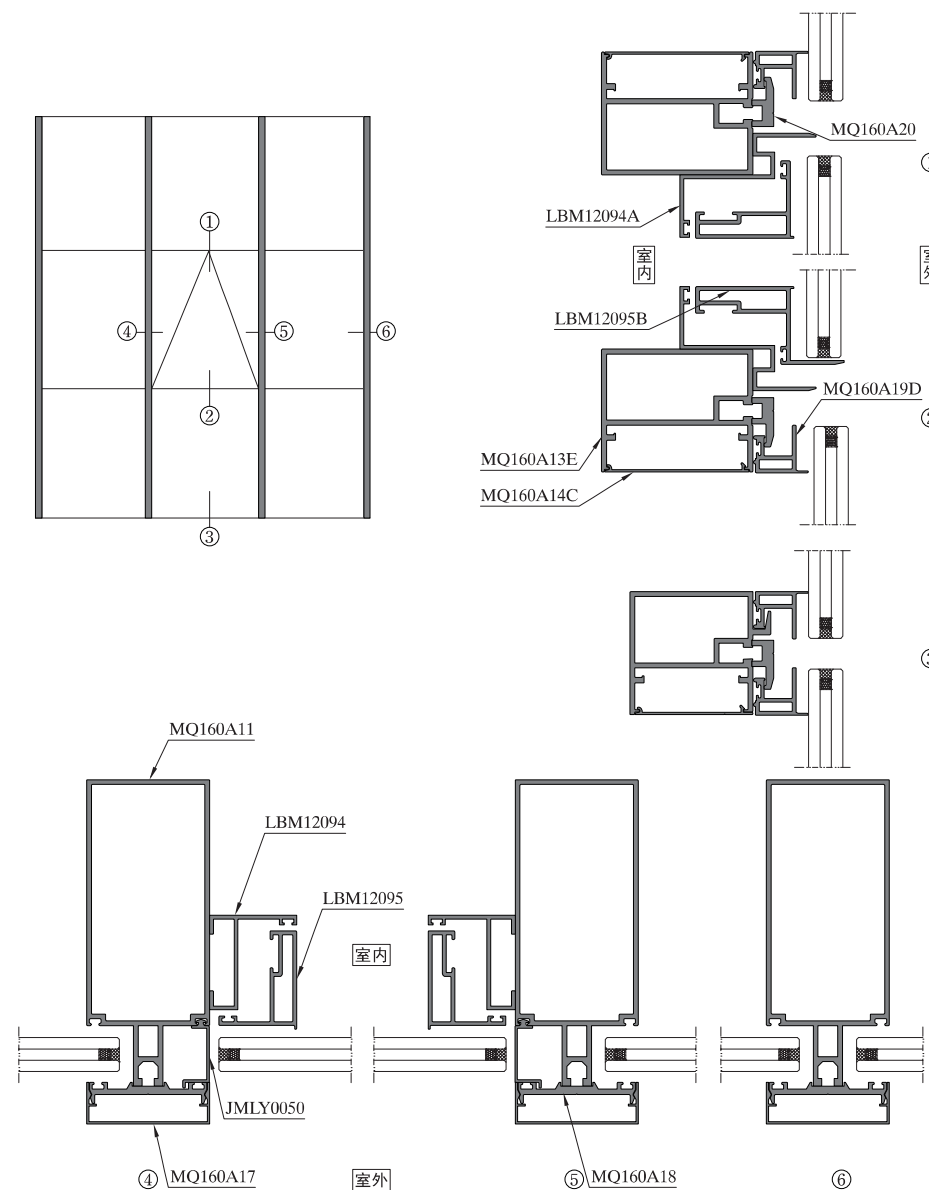
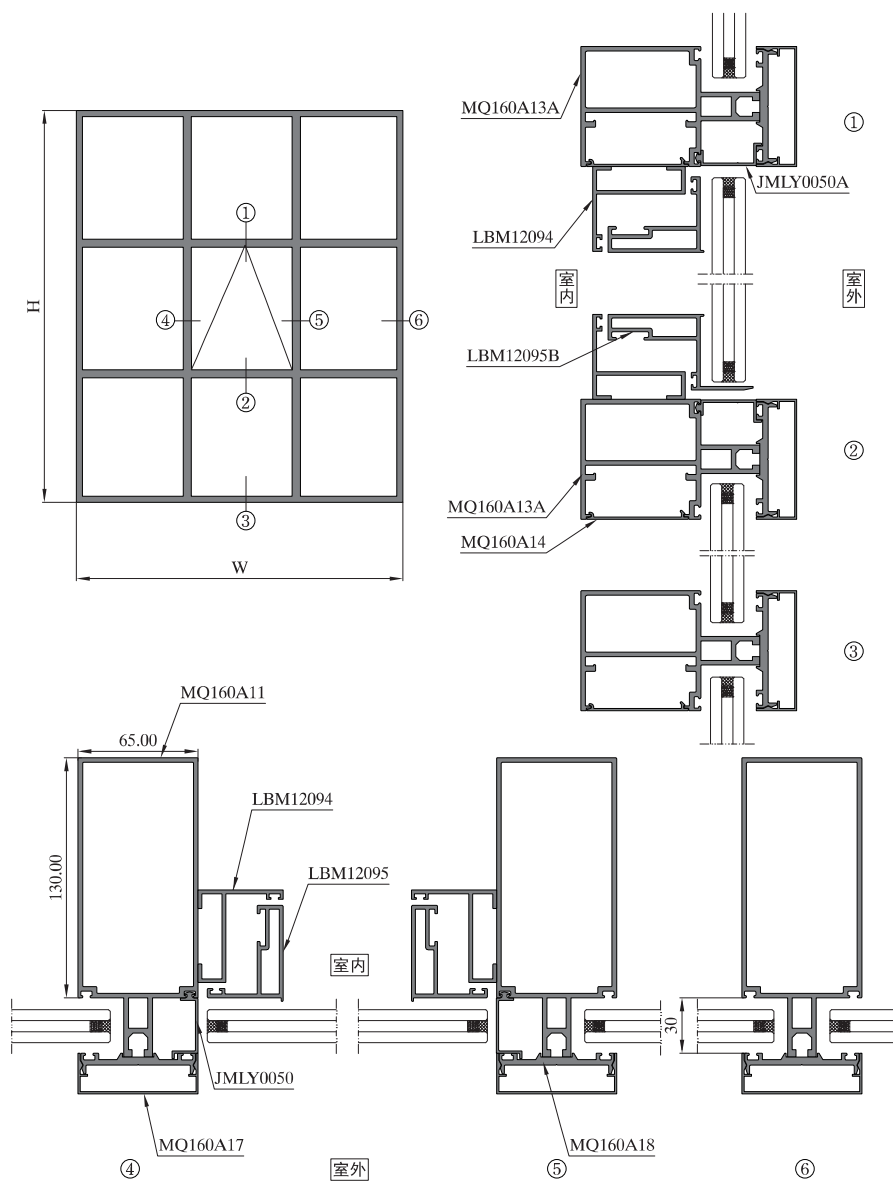

图中所示型材截面、装配、编号、尺寸及重量仅供参考。如有疑问，请向本公司查询。
Information above just for your reference. Please contact us if you have any questions, Thank you!

图中所示型材截面、装配、编号、尺寸及重量仅供参考。如有疑问，请向本公司查询。
Information above just for your reference. Please contact us if you have any questions, Thank you!

序号 S/N	型号理论重量 JMA Code & KG/M	型材图 Drawing	序号 S/N	型号理论重量 JMA Code & KG/M	型材图 Drawing	序号 S/N	型号理论重量 JMA Code & KG/M	型材图 Drawing
1	MQ12051B 3.289kg/m		10	JMCW03764 3.957kg/m		19	MQ160A14B 0.242kg/m	
2	MQ160A11 3.435kg/m		11	MQ160A12 3.844kg/m		20	MQ160A14C 0.293kg/m	
3	MQ160A11H 4.166kg/m		12	MQ160A12B 3.317kg/m		21	MQ160A15B 1.494kg/m	
4	MQ160A11G 4.604kg/m		13	JMCW03771 3.866kg/m		22	MQ160A16B 1.258kg/m	
5	MQ160A11A 2.951kg/m		14	MQ160A13A 2.632kg/m		23	LBM12094 0.752kg/m	
6	MQ160A11B 3.576kg/m		15	MQ160A13C 3.350kg/m		24	LBM12094A 0.868kg/m	
7	MQ160A11C 2.927kg/m		16	MQ160A13D 2.256kg/m		25	LBM12095 0.948kg/m	
8	MQ160A11D 3.219kg/m		17	MQ160A13E 2.434kg/m		26	LBM12095B 1.108kg/m	
9	MQ160A11F 3.448kg/m		18	MQ160A14 0.217kg/m		27	MQ160A17 0.419kg/m	

序号 S/N	型号理论重量 JMA Code & KG/M	型材图 Drawing	序号 S/N	型号理论重量 JMA Code & KG/M	型材图 Drawing	序号 S/N	型号理论重量 JMA Code & KG/M	型材图 Drawing
28	MQ160A18 0.775kg/m		37	JMLY0050 0.238kg/m		46		
29	MQ160A19 0.732kg/m		38	JMLY0050A 0.221kg/m		47		
30	MQ160A19B 0.826kg/m		39			48		
31	MQ160A19C 1.117kg/m		40			49		
32	MQ160A19D 0.522kg/m		41			50		
33	MQ160A19F 0.589kg/m		42			51		
34	MQ160A19G 0.650kg/m		43			52		
35	MQ160A20 0.473kg/m		44			53		
36	MQ160A20A 0.606kg/m		45			54		

图中所示型材截面、装配、编号、尺寸及重量仅供参考。如有疑问，请向本公司查询。
Information above just for your reference. Please contact us if you have any questions, Thank you!

图中所示型材截面、装配、编号、尺寸及重量仅供参考。如有疑问，请向本公司查询。
Information above just for your reference. Please contact us if you have any questions, Thank you!

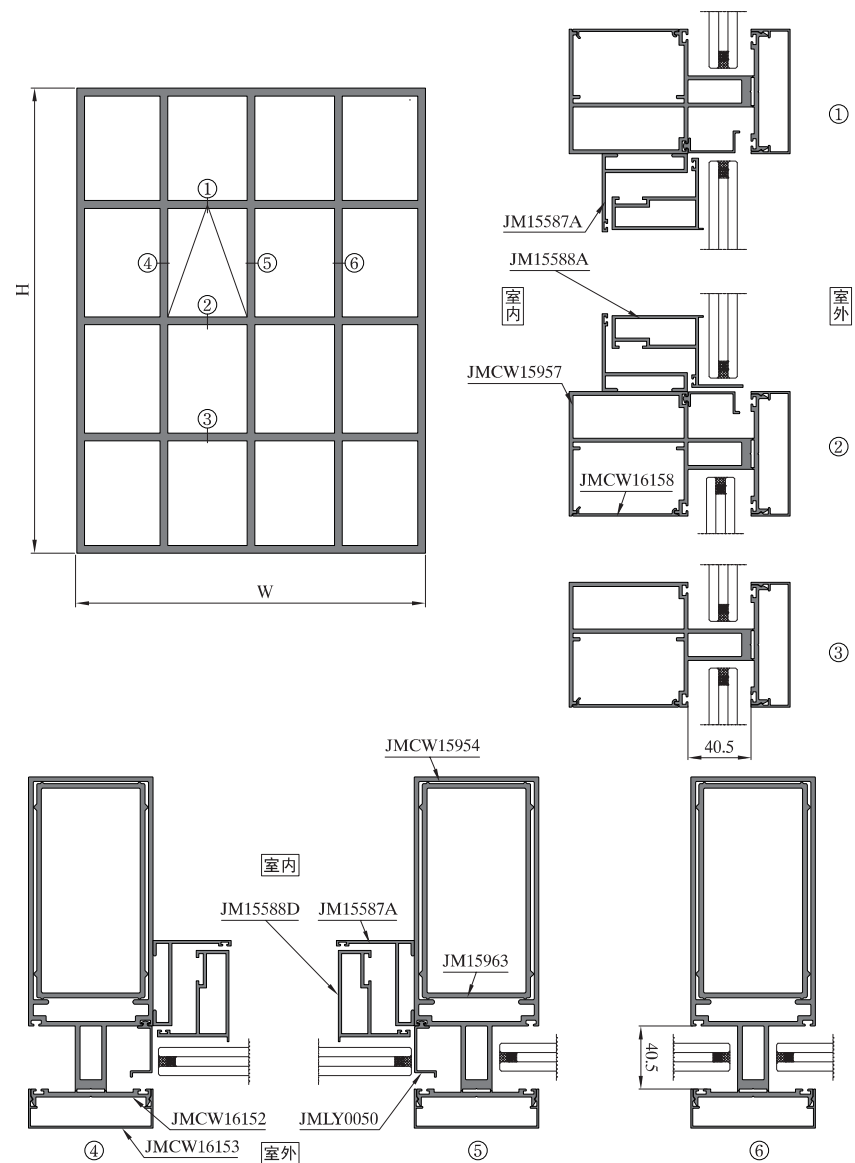
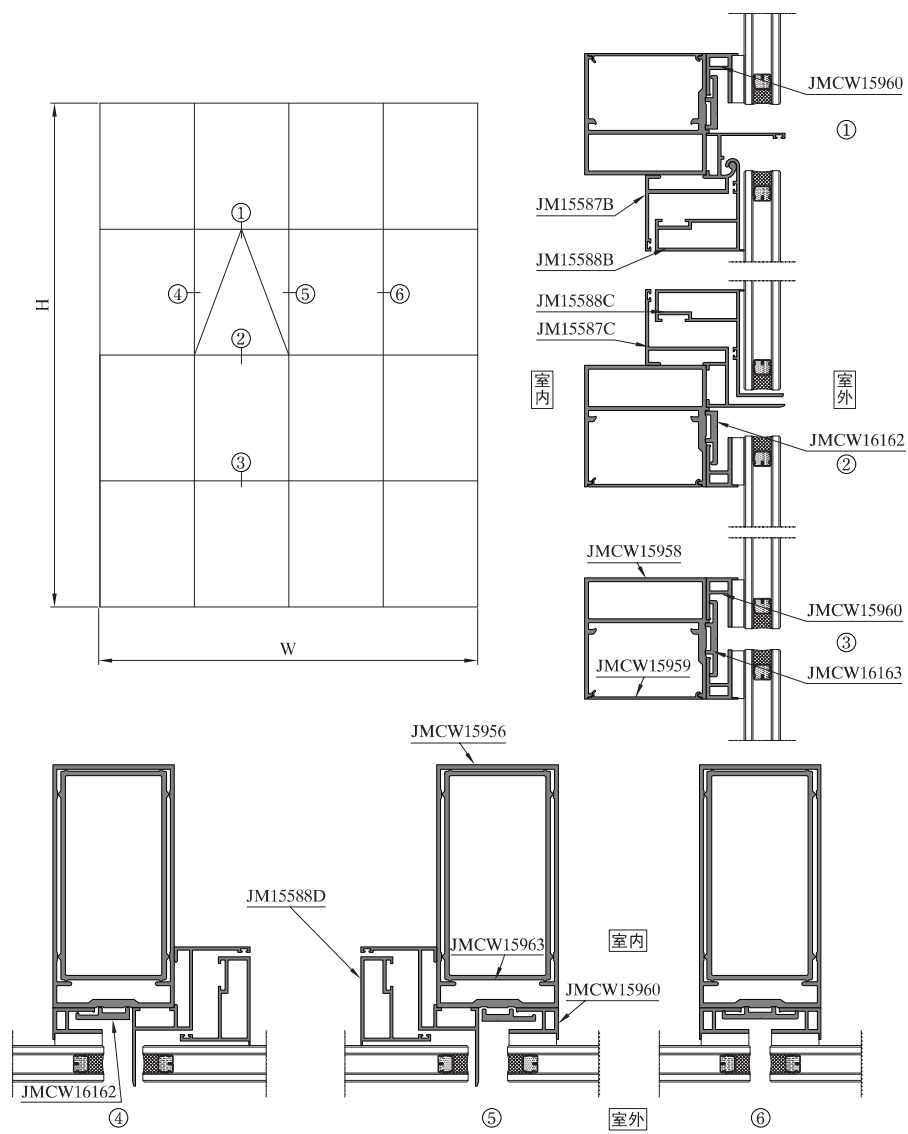

序号 S/N	型号理论重量 JMA Code & KG/M	型材图 Drawing	序号 S/N	型号理论重量 JMA Code & KG/M	型材图 Drawing	序号 S/N	型号理论重量 JMA Code & KG/M	型材图 Drawing
1	JMCW15954 5.304kg/m	套芯配JMCW15963 201.5 140 80 74 3 160	10	JMCW15959 0.357kg/m	6 1.5 75.1	19	JMCW16157 3.402kg/m	155.5 80 2.2
2	JMCW15955 6.182kg/m	套芯配JMCW15963 223.47 140 80 74 3 90°	11	JMCW15960 0.612kg/m	32.5 21 2.5	20	JMCW16159 0.283kg/m	26 24.5 2
3	JMCW15956 4.040kg/m	套芯配JMCW15963 160 140 80 74 2.5	12	JMCW15961 0.691kg/m	32.5 27 2.5	21	JMCW16160 1.979kg/m	80 2.5 80
4	JMCW15957 3.209kg/m	盖板配JMCW16158 117.8 80 2.5 76.3	13	JMCW15962 0.149kg/m	9.5 9.5	22	JMCW16161 0.964kg/m	装饰盖板JMCW16160 72.71 25.05 2
5	JMCW15958 2.570kg/m	盖板配JMCW15959 80 2.5 80	14	JMCW16152 0.775kg/m	装饰盖板JMCW16153 76.8 10.85	23	JMCW16211 0.852kg/m	80 40 1.2
6	JMCW15963 3.602kg/m	139.5 75.5 3	15	JMCW16153 0.499kg/m	80 25 1.2	24	JMCW16212 0.265kg/m	装饰盖板JMCW16211 37.63 7.1 2
7	JMCW16162 0.457kg/m	20.5 35.25 8	16	JMCW16154 1.159kg/m	30.5 77.4 3	25	JMGY11315 0.437kg/m	40 28 1.2
8	JMCW16163 0.606kg/m	50 20.5 8	17	JMCW16155 0.195kg/m	44.5 1.2 7.7	26	JM15587 1.023kg/m	52 50 2.5
9	JMCW16158 0.327kg/m	6 1.5 68.2	18	JMCW16156 3.229kg/m	144.5 2.2 80	27	JM15587A 0.760kg/m	54.7 50 2

序号 S/N	型号理论重量 JMA Code & KG/M	型材图 Drawing	序号 S/N	型号理论重量 JMA Code & KG/M	型材图 Drawing	序号 S/N	型号理论重量 JMA Code & KG/M	型材图 Drawing
28	JM15587B 1.403kg/m	77.75 2.5 54.7	37			46		
29	JM15587C 1.284kg/m	91.7 77.5 2	38			47		
30	JM15588 1.025kg/m	角码配JM5004A 2 33.8 12.5 58.5	39			48		
31	JM15588A 1.213kg/m	角码配JM5004A 46 2 58.5	40			49		
32	JM15588B 1.212kg/m	角码配JM5004A 2 61 12.5 58.5	41			50		
33	JM15588C 1.392kg/m	角码配JM5004A 2 70.5 12.5 58.5	42			51		
34	JM15588D 1.08kg/m	角码配JM5004A 2 46 12.5 58.5	43			52		
35	JMLY0050 0.238kg/m	1.3 14 36.3	44			53		
36			45			54		

图中所示型材截面、装配、编号、尺寸及重量仅供参考。如有疑问，请向本公司查询。
 Information above just for your reference. Please contact us if you have any questions, Thank you!

图中所示型材截面、装配、编号、尺寸及重量仅供参考。如有疑问，请向本公司查询。
 Information above just for your reference. Please contact us if you have any questions, Thank you!

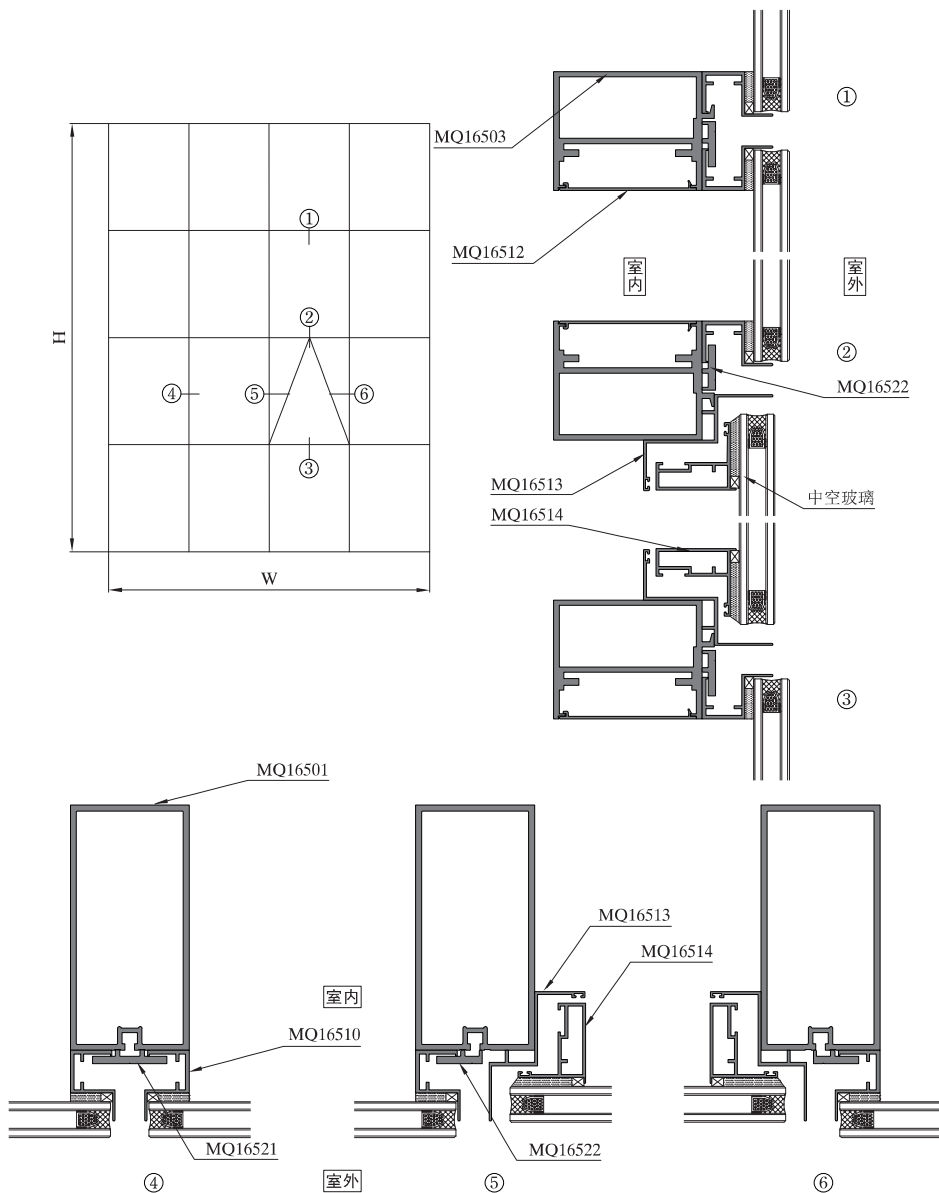

序号 S/N	型号理论重量 JMA Code & KG/M	型材图 Drawing	序号 S/N	型号理论重量 JMA Code & KG/M	型材图 Drawing	序号 S/N	型号理论重量 JMA Code & KG/M	型材图 Drawing
1	MQ16501 5.766kg/m	套芯配MQ16502 80x165 4	10	MQ16503D 4.088kg/m	配MQ16512 80x108 3 100	19	MQ16518 0.342kg/m	27x28 2
2	MQ16501C 5.016kg/m	套芯配MQ16502 80x180 5	11	MQ16504 5.999kg/m	配MQ16512 80x129.5 4 153.2	20	MQ16511 0.689kg/m	17.5x47.5 30 2
3	MQ16501A 7.302kg/m	套芯配MQ16502A 80x200 4	12	MQ16512 0.512kg/m	5.25x92.1 1.75	21	MQ16521 0.807kg/m	19.5x50 9.3
4	MQ16502 4.249kg/m	71.6x144.7 5.5	13	MQ16506 0.818kg/m	12.5x76.85	22	MQ16522 0.504kg/m	14.5x30.5 9
5	MQ16502A 5.593kg/m	71.6x178.5 4	14	MQ16505A 0.436kg/m	20x80 1.2	23	MQ16515 0.787kg/m	25x40
6	MQ16507 2.120kg/m	53.2x80 18.5 3	15	MQ16505 1.496kg/m	80x110 1.5	24	MQ16517 1.342kg/m	28.8x68.2
7	MQ16509 2.313kg/m	53.2x80 29.5 3	16	MQ16519 0.942kg/m	64.5x76 2	25	JMGRS257B 2.262kg/m	55x55 9.8
8	MQ16503C 3.973kg/m	盖板配MQ16512 80x100 3	17	MQ16520 1.003kg/m	52x81.8 2.5	26		
9	MQ16503 4.471kg/m	盖板配MQ16512 80x100 4	18	MQ16514 1.011kg/m	角码配JMGRS257B 45.5x54 2 10	27		

图中所示型材截面、装配、编号、尺寸及重量仅供参考。如有疑问，请向本公司查询。
Information above just for your reference. Please contact us if you have any questions, Thank you!

图中所示型材截面、装配、编号、尺寸及重量仅供参考。如有疑问，请向本公司查询。
Information above just for your reference. Please contact us if you have any questions, Thank you!

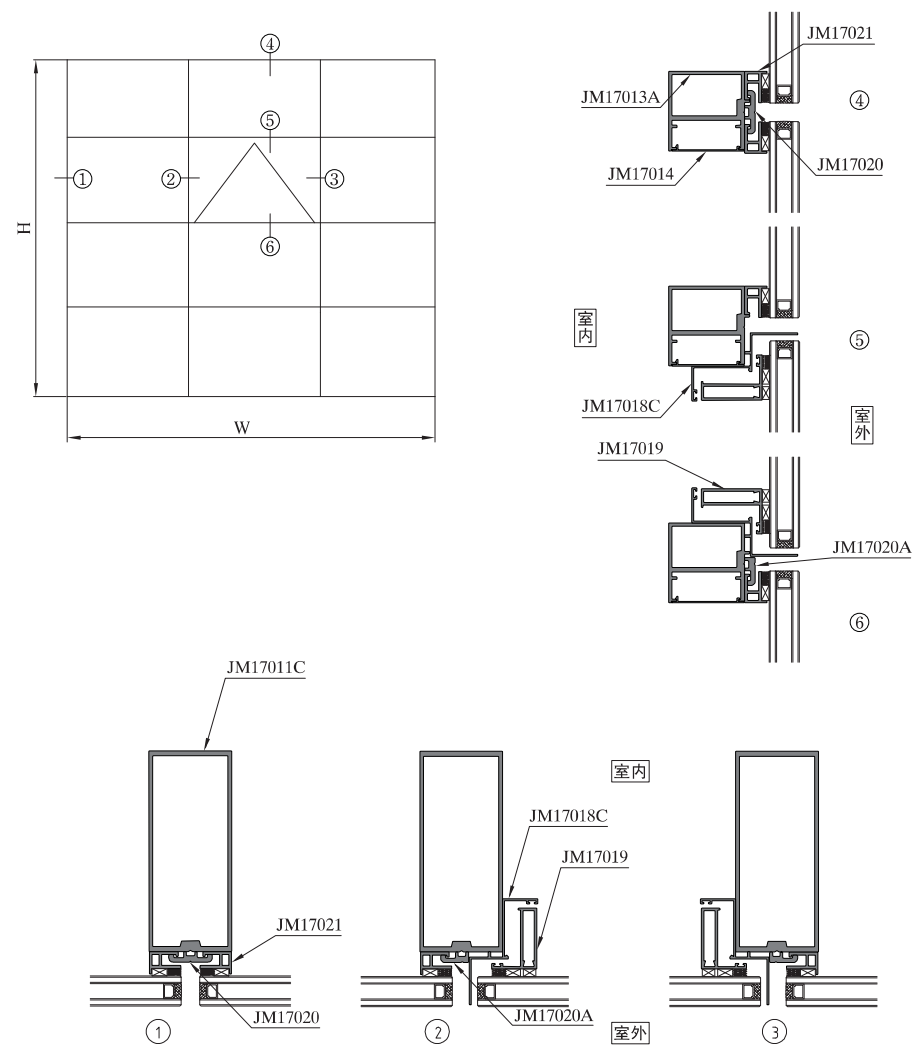
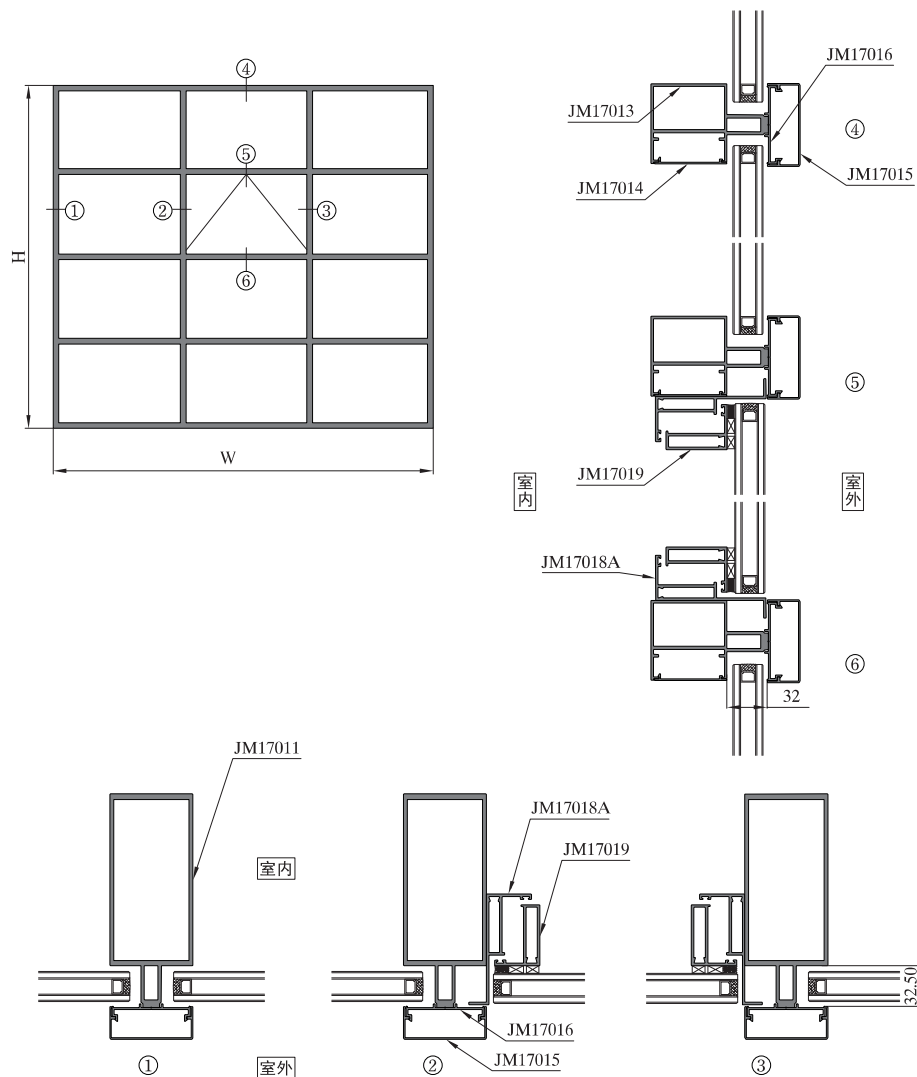

序号 S/N	型号理论重量 JMA Code & KG/M	型材图 Drawing	序号 S/N	型号理论重量 JMA Code & KG/M	型材图 Drawing	序号 S/N	型号理论重量 JMA Code & KG/M	型材图 Drawing
1	JM17011 4.551kg/m		10	JM17012D 3.216kg/m		19	JM17013M 2.039kg/m	
2	JM17011A 3.849kg/m		11	JM17013 2.214kg/m		20	JM17013N 1.878kg/m	
3	JM17011B 3.262kg/m		12	JM17013A 1.760kg/m		21	JM17013P 1.215kg/m	
4	JM17011F 3.538kg/m		13	JM17013B 2.163kg/m		22	JM17013Q 1.125kg/m	
5	JM17011C 4.409kg/m		14	JM17013C 1.759kg/m		23	JM17013R 1.544kg/m	
6	JM17011D 5.331kg/m		15	JM17013E 2.782kg/m		24	JM17015A 1.461kg/m	
7	JM17012 2.627kg/m		16	JM17013H 2.148kg/m		25	JM17015B 0.613kg/m	
8	JM17012A 2.400kg/m		17	JM17013F 2.188kg/m		26	JM17015BA 0.852kg/m	
9	JM17012C 3.014kg/m		18	JM17013W 2.432kg/m		27	JM17015C12 0.593kg/m	

序号 S/N	型号理论重量 JMA Code & KG/M	型材图 Drawing	序号 S/N	型号理论重量 JMA Code & KG/M	型材图 Drawing	序号 S/N	型号理论重量 JMA Code & KG/M	型材图 Drawing
28	JM17015D15 2.104kg/m		37	JM17018B 1.241kg/m		46	JM17014C 0.287kg/m	
29	JM17015U 1.188kg/m		38	JM17018C 0.677kg/m		47	JM13804E 0.275kg/m	
30	JM17015Q 1.815kg/m		39	JM17018D 1.151kg/m		48	JM17014 0.229kg/m	
31	JM17015X 0.845kg/m		40	JM17018J 1.083kg/m		49	JM17016A 0.541kg/m	
32	JM17015K 0.556kg/m		41	JM17019 0.864kg/m		50	JM17016M 0.740kg/m	
33	JM17015T 0.546kg/m		42	JM17019A 0.897kg/m		51	JM17016N 0.961kg/m	
34	JM17015W 1.998kg/m		43	JM17019D 0.916kg/m		52	JM17016 0.414kg/m	
35	JM17018 0.856kg/m		44	JM17019G 1.176kg/m		53	JM17015 0.445kg/m	
36	JM17018A 1.170kg/m		45	JM13804A 0.215kg/m		54	JM17017 1.584kg/m	

图中所示型材截面、装配、编号、尺寸及重量仅供参考。如有疑问，请向本公司查询。
Information above just for your reference. Please contact us if you have any questions, Thank you!

图中所示型材截面、装配、编号、尺寸及重量仅供参考。如有疑问，请向本公司查询。
Information above just for your reference. Please contact us if you have any questions, Thank you!

序号 S/N	型号理论重量 JMA Code & KG/M	型材图 Drawing	序号 S/N	型号理论重量 JMA Code & KG/M	型材图 Drawing	序号 S/N	型号理论重量 JMA Code & KG/M	型材图 Drawing
55	JM17017A 1.597kg/m		64	JM3824 1.331kg/m		73		
56	JM17022 1.432kg/m		65	GRB506 2.991kg/m		74		
57	JM17020B 0.419kg/m		66			75		
58	JM17020 0.483kg/m		67			76		
59	JM17020A 0.337kg/m		68			77		
60	JM17020C 0.258kg/m		69			78		
61	JM17021 0.467kg/m		70			79		
62	JM17022B 0.177kg/m		71			80		
63	PC386682 1.475kg/m		72			81		

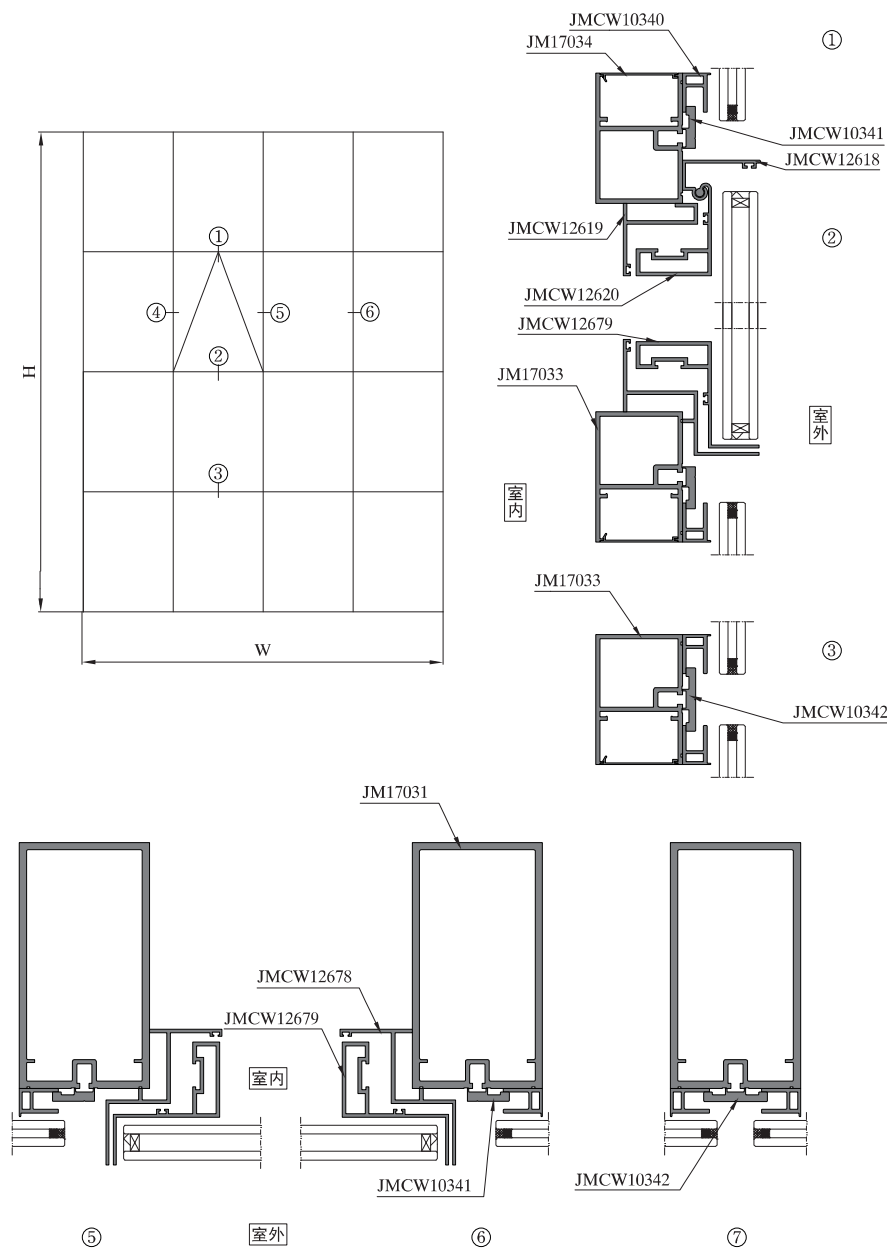

图中所示型材截面、装配、编号、尺寸及重量仅供参考。如有疑问，请向本公司查询。
Information above just for your reference. Please contact us if you have any questions, Thank you!

图中所示型材截面、装配、编号、尺寸及重量仅供参考。如有疑问，请向本公司查询。
Information above just for your reference. Please contact us if you have any questions, Thank you!

序号 S/N	型号理论重量 JMA Code & KG/M	型材图 Drawing	序号 S/N	型号理论重量 JMA Code & KG/M	型材图 Drawing	序号 S/N	型号理论重量 JMA Code & KG/M	型材图 Drawing
1	JM17031 7.608kg/m	套芯配JM17032 170 5 90	10	JM17037 1.467kg/m	87 3 46	19	JMCW12616 1.097kg/m	95 2.5 65
2	JM17032 6.168kg/m	144.5 5 79.5	11	JM17037A 0.874kg/m	85.6 10 3	20	JMCW12617 1.447kg/m	角码配PC386682 82.5 43.5 2.5 8.5 52
3	JM17033 2.786kg/m	盖板配JM17034 90 3 60	12	JMCW10341 0.513kg/m	29 9	21	JMCW12618 0.618kg/m	54 2 27.8
4	JM17033A 6.133kg/m	盖板配JM17034A 170 4 90	13	JMCW10342 0.745kg/m	44 9	22	JMCW12619 0.928kg/m	51.5 2.5 50
5	JM17034 0.218kg/m	6 1.2 53.6	14	JMCW10340 0.543kg/m	19.5 27 2.5	23	JMCW12620 1.498kg/m	角码配PC386682 64 2.5 8.5 52
6	JM17034A 0.968kg/m	6.1 2 163.6	15	JMCW10347 0.673kg/m	30.5 27 2.5	24	JMCW12678 1.360kg/m	94 2.5 50
7	JM17035 2.628kg/m	90 2 140	16	CKHK6375 5.762kg/m	套芯配CKHK6383 190 5 90	25	JMCW12679 1.639kg/m	角码配PC386682 85 2 73.5 8.5
8	JM17035A 0.646kg/m	90 26 1.5	17	CKHK6383 3.889kg/m	146.8 83.5 3	26	PC386682 1.475kg/m	38 38 8.2
9	JM17036 1.008kg/m	90 19.2 2	18	JMCW12617 1.447kg/m	角码配PC386682 82.5 43.5 2.5 8.5 52	27		

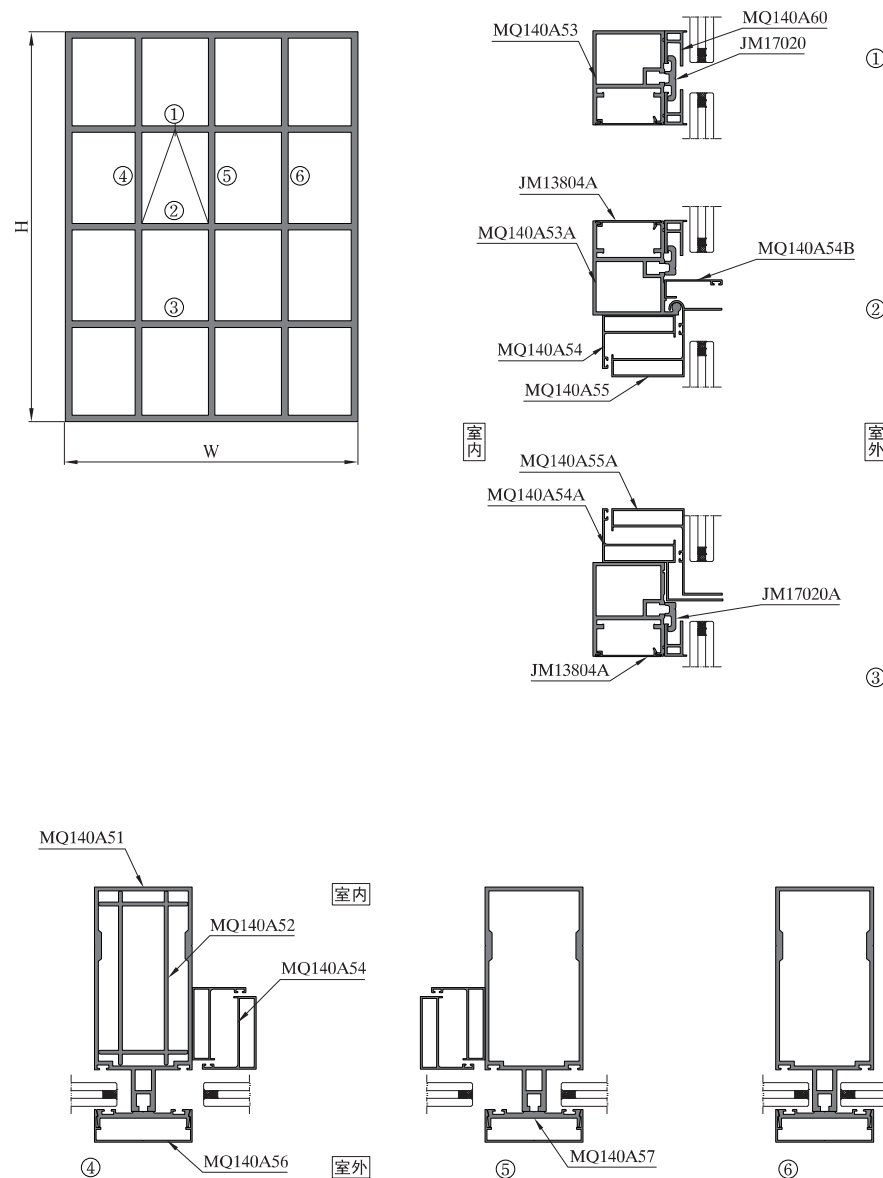

图中所示型材截面、装配、编号、尺寸及重量仅供参考。如有疑问，请向本公司查询。
Information above just for your reference. Please contact us if you have any questions, Thank you!

图中所示型材截面、装配、编号、尺寸及重量仅供参考。如有疑问，请向本公司查询。
Information above just for your reference. Please contact us if you have any questions, Thank you!

序号 S/N	型号理论重量 JMA Code & KG/M	型材图 Drawing	序号 S/N	型号理论重量 JMA Code & KG/M	型材图 Drawing	序号 S/N	型号理论重量 JMA Code & KG/M	型材图 Drawing
1	MQ140A51 4.843kg/m	套芯配MQ140A52 140 172 75 3	10	MQ140A52A 3.375kg/m	92.5 110 3	19	MQ140A55 0.934kg/m	角码配F-50625 84.5 1.4 58.4 11.2
2	MQ140A51A 6.499kg/m	套芯配MQ140A52 221.92 75 3	11	MQ140A52B 2.722kg/m	63.5 103.5 3	20	MQ140A55A 0.918kg/m	角码配F-50625 84.55 1.4 66.1 11.2
3	MQ140A51B 3.055kg/m	44 120 3	12	JMCW10422 2.686kg/m	69.3 111 2.6	21	JM13804A 0.215kg/m	50 1.2 6.7
4	JMCW12601 3.304kg/m	150 120 75 2.5	13	MQ140A53 2.188kg/m	盖板配JM13804A 55 72 2.5	22	JM13804E 0.275kg/m	67 1.2
5	JMCW12580 4.007kg/m	140 170 75 2.5	14	MQ140A53A 2.397kg/m	盖板配JM13804A 67.6 72 2.5	23	JMCW12615 0.282kg/m	75.1 1.2 3.9
6	JMCW10421 3.762kg/m	套芯配JMCW10422 75 123 2.6	15	JMCW12614 2.593kg/m	盖板配JMCW12615 80 75 3	24	MQ140A56 0.553kg/m	底板配MQ140A57 25 1.4 75
7	MQ140A51C 6.017kg/m	套芯配MQ140A52A 200 152 100 3	16	JMCW12583 2.452kg/m	盖板配JM13804E 105 75 75 5	25	MQ140A56A 0.532kg/m	底板配MQ140A57A 25 1.4 70
8	MQ140A51D 9.262kg/m	套芯配MQ140A52A 179.41 255.43 90° 100 3.5	17	MQ140A54 0.696kg/m	角码配F-50625 11.2 1.4 41 55.55	26	JMCW12582 0.416kg/m	底板配JMCW12581 75 19 1.2 1.8
9	MQ140A52 3.419kg/m	68.5 3 133.5	18	MQ140A54A 0.987kg/m	角码配F-50625 92.05 1.4 41 11.2	27	MQ140A57 0.987kg/m	装饰盖配MQ140A56 71.37 13.5 4

序号 S/N	型号理论重量 JMA Code & KG/M	型材图 Drawing	序号 S/N	型号理论重量 JMA Code & KG/M	型材图 Drawing	序号 S/N	型号理论重量 JMA Code & KG/M	型材图 Drawing
28	MQ140A57A 0.929kg/m	装饰盖配MQ140A56A 66.37 13.5 4	37	MQ140A58A 8.860kg/m	盖板配MQ140A59 200 258.1 7	46		
29	JMCW12581 0.744kg/m	装饰盖配JMCW12582 72.57 14.8 2	38	MQ140A57C 3.104kg/m	197.3 30.5 4	47		
30	MQ140A54B 0.260kg/m	44 14.1 1.2	39	MQ140A59 0.156kg/m	装饰盖配MQ140A58A 32 11	48		
31	MQ140A60 0.433kg/m	27 17 2	40	F-50625 1.786kg/m	50 11 50	49		
32	MQ140A60A 0.644kg/m	27 35 2	41	JM17020 0.483kg/m	8.5 34.6	50		
33	MQ140A57B 1.515kg/m	72.3 4 30.5	42	JM17020A 0.337kg/m	8.5 22.3	51		
34	MQ140A58 2.742kg/m	75 1.8 149.7	43			52		
35	MQ140A56B 2.468kg/m	75 162.5 1.8	44			53		
36	MQ140A56C 7.909kg/m	装饰盖配MQ140A58A 200 256 3	45			54		

图中所示型材截面、装配、编号、尺寸及重量仅供参考。如有疑问，请向本公司查询。
 Information above just for your reference. Please contact us if you have any questions, Thank you!

图中所示型材截面、装配、编号、尺寸及重量仅供参考。如有疑问，请向本公司查询。
 Information above just for your reference. Please contact us if you have any questions, Thank you!

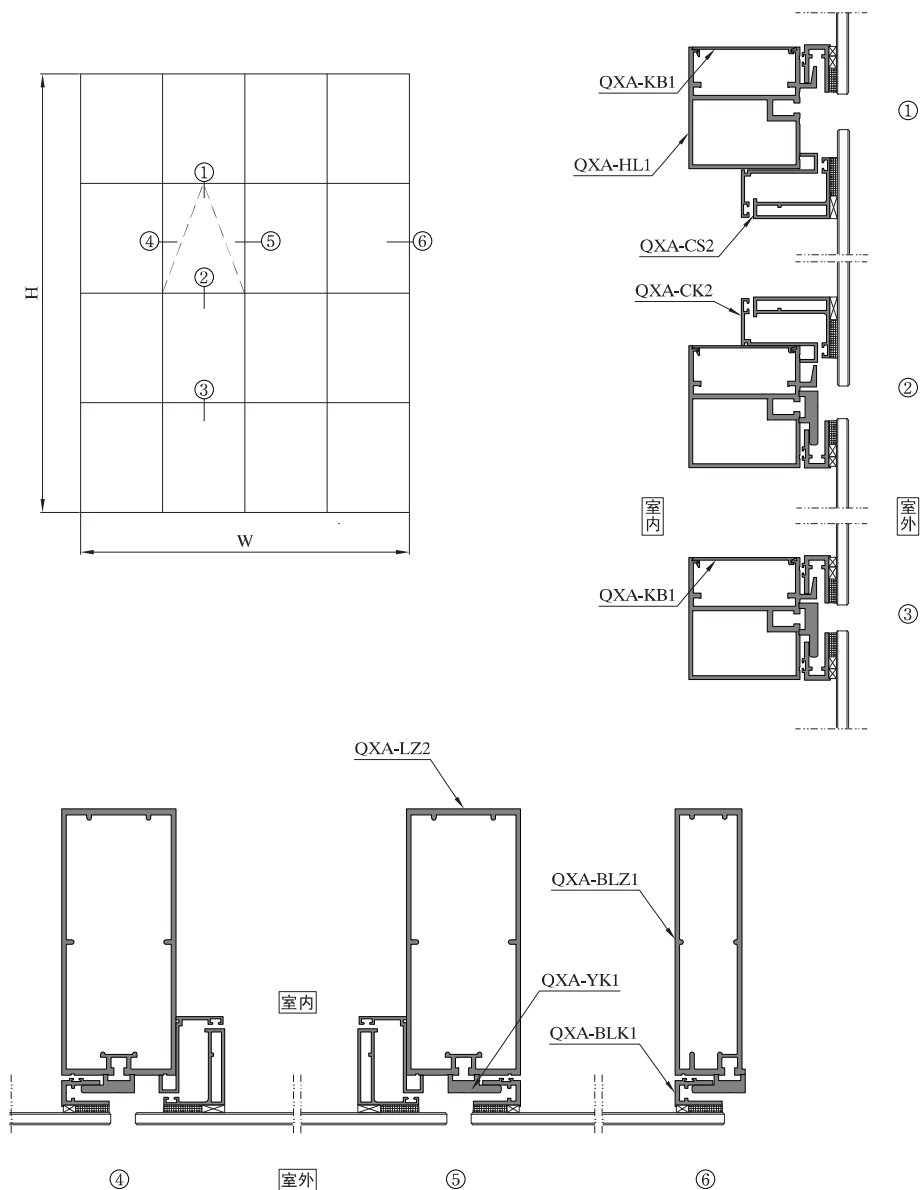

序号 S/N	型号理论重量 JMA Code & KG/M	型材图 Drawing	序号 S/N	型号理论重量 JMA Code & KG/M	型材图 Drawing	序号 S/N	型号理论重量 JMA Code & KG/M	型材图 Drawing
1	QXA-LZ1 7.173kg/m	与QXA-XT1配合 75 4.3 185	10	QXA-BLZ3 3.843kg/m	与QXA-BXT2配合 54 3 138	19	QXA-CK5 0.437kg/m	与QXA-CK6配合 31.5 2
2	QXA-LZ2 5.027kg/m	与QXA-XT1配合 75 3 175	11	QX-LZ2 2.322kg/m	66 2 90	20	QXA-CK6 0.498kg/m	27.5 2 31.5
3	QXA-LZ3 5.491kg/m	套芯配JM13802 72 3 155	12	QXA-HL1 2.912kg/m	与QXA-KB1配合 80 2.5 84	21	QXA-CK7 0.812kg/m	63 2 5.5
4	QXA-LZ4 5.843kg/m	套芯配JM13802 72 3 165	13	QXA-HL2 2.424kg/m	与QXA-KB1配合 2 72 73	22	QXA-CS2 0.891kg/m	角码配JM4026A 2 6.8 40 50
5	QXA-XT1 4.166kg/m	58.5 3.5 151.8	14	QX-HL7 2.268kg/m	与QXA-KB1配合 3 66 68	23	QXA-CS3 0.881kg/m	角码配JM4026A 40 6.8 2 50
6	QXA-BXT1 3.643kg/m	32.5 3.5 152.3	15	QXA-KB1 0.329kg/m	与QXA-HL1配合 6.5 67.5 1.5	24	QX-JQJ2 1.210kg/m	2 20 75
7	QXA-BLZ1 4.234kg/m	与QXA-BXT1配合 46.1 3 175	16	QXA-CK2 0.622kg/m	与QXA-CS2配合 42 2 50	25	QX-BYK1 0.685kg/m	40 2 51
8	QXA-BXT2 2.142kg/m	23.6 3 106.5	17	QXA-CK3 0.771kg/m	55 2 50	26	QX-BYK39 0.685kg/m	43 2 51
9	QXA-BLZ2 4.404kg/m	与QXA-BXT2配合 54 3 155	18	QXA-CK4 0.929kg/m	50 2 60	27	QX-HLB5 1.425kg/m	43 2.5 90

图中所示型材截面、装配、编号、尺寸及重量仅供参考。如有疑问，请向本公司查询。
Information above just for your reference. Please contact us if you have any questions, Thank you!

图中所示型材截面、装配、编号、尺寸及重量仅供参考。如有疑问，请向本公司查询。
Information above just for your reference. Please contact us if you have any questions, Thank you!

序号 S/N	型号理论重量 JMA Code & KG/M	型材图 Drawing	序号 S/N	型号理论重量 JMA Code & KG/M	型材图 Drawing	序号 S/N	型号理论重量 JMA Code & KG/M	型材图 Drawing
28	QX-LZB7 1.457kg/m		37	QX-YK3 0.399kg/m		46		
29	QXA-LBK1 0.564kg/m		38	QXA-JLT1 0.845kg/m		47		
30	QX-XK8 0.515kg/m		39	QXA-JLT2 0.897kg/m		48		
31	QXA-BLK1 0.573kg/m		40	QXA-JM1 0.973kg/m		49		
32	QXA-BLK2 0.564kg/m		41	QXA-ZJK1 0.951kg/m		50		
33	QX-CL1 0.666kg/m		42	QXA-ZJK2 0.986kg/m		51		
34	QXA-YK1 0.757kg/m		43	QXA-JM2 1.169kg/m		52		
35	QXA-YK2 0.972kg/m		44			53		
36	QX-YK2 0.381kg/m		45			54		

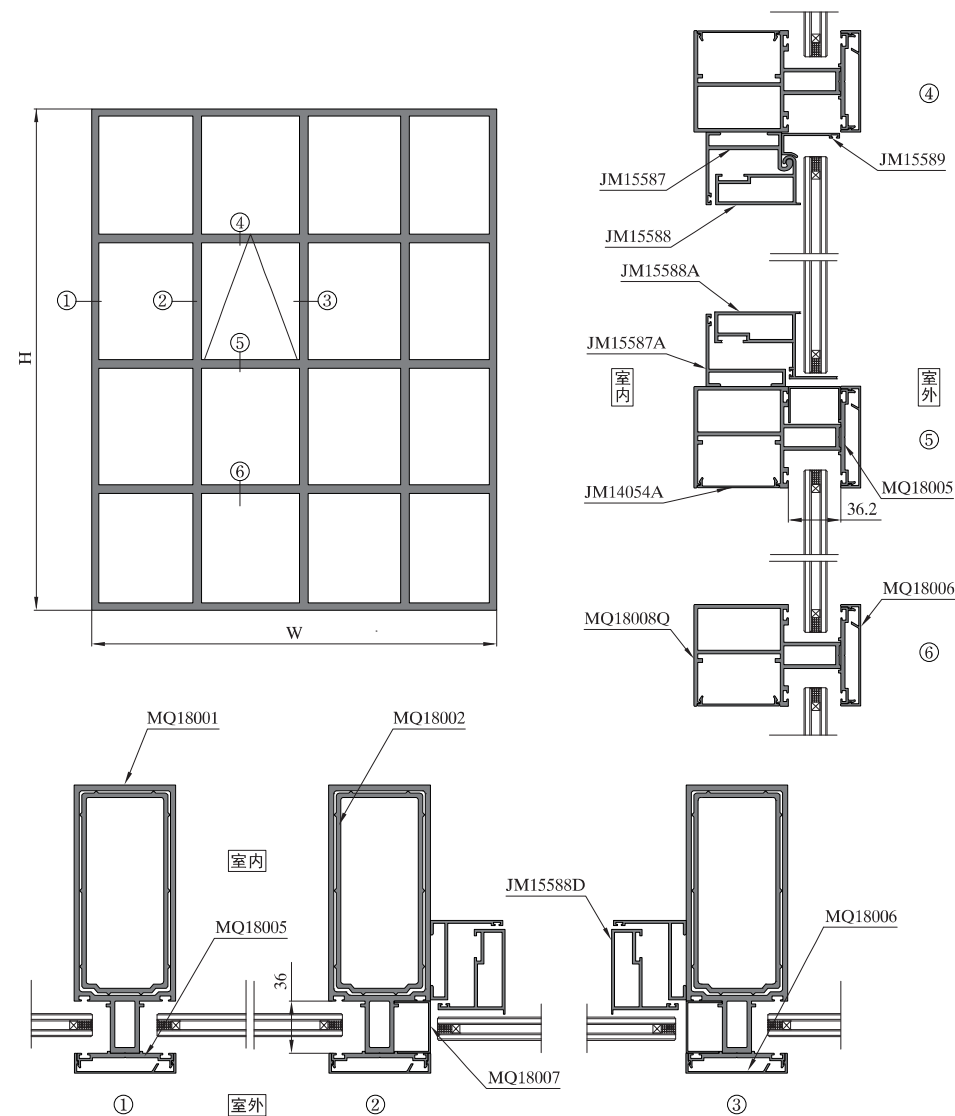

图中所示型材截面、装配、编号、尺寸及重量仅供参考。如有疑问，请向本公司查询。
Information above just for your reference. Please contact us if you have any questions, Thank you!









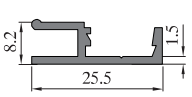
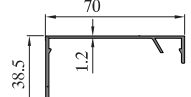
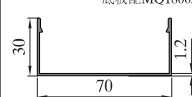
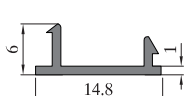
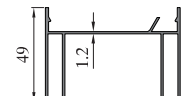

图中所示型材截面、装配、编号、尺寸及重量仅供参考。如有疑问，请向本公司查询。
Information above just for your reference. Please contact us if you have any questions, Thank you!

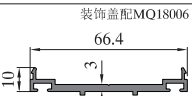
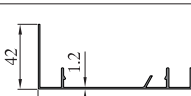
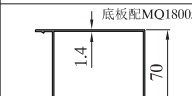
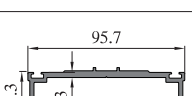
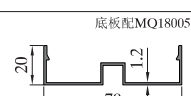
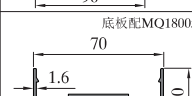
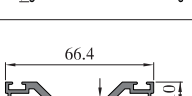
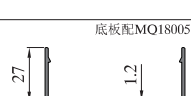
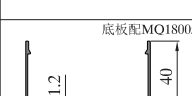
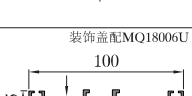
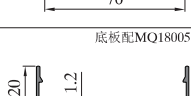
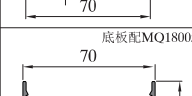

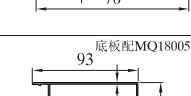
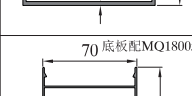
序号 S/N	型号理论重量 JMA Code & KG/M	型材图 Drawing	序号 S/N	型号理论重量 JMA Code & KG/M	型材图 Drawing	序号 S/N	型号理论重量 JMA Code & KG/M	型材图 Drawing
1	MQ18001 5.376kg/m	套芯配MQ18002 	10	MQ18001L 5.662kg/m	套芯配MQ18002 	19	MQ18002 3.392kg/m	
2	MQ18001A 5.375kg/m	套芯配MQ18002A 	11	MQ18001M 6.416kg/m	套芯配MQ18002 	20	MQ18002A 3.620kg/m	
3	MQ18001B 4.972kg/m	套芯配MQ18002B 	12	MQ18001P 4.577kg/m		21	MQ18002B 2.462kg/m	
4	MQ18001C 4.690kg/m	套芯配MQ18002C 	13	MQ18001Q 4.051kg/m		22	MQ18002C 2.970kg/m	
5	MQ18001D 3.432kg/m		14	MQ18001K 3.642kg/m	套芯配MQ18002J 	23	MQ18002F 6.542kg/m	
6	MQ18001E 4.567kg/m	套芯配MQ180010 	15	MQ180011 9.205kg/m	套芯配MQ180012 	24	MQ18002G 2.955kg/m	
7	MQ18001F 9.811kg/m	套芯配MQ18002F 	16	MQ18008 3.707kg/m		25	MQ180010 3.913kg/m	
8	MQ18009 4.542kg/m	套芯配MQ180010 	17	MQ18008A 3.154kg/m		26	MQ180012 7.410kg/m	
9	MQ18001H 4.163kg/m	套芯配MQ18002G 	18	MQ180013 3.641kg/m		27	MQ18002J 2.269kg/m	

序号 S/N	型号理论重量 JMA Code & KG/M	型材图 Drawing	序号 S/N	型号理论重量 JMA Code & KG/M	型材图 Drawing	序号 S/N	型号理论重量 JMA Code & KG/M	型材图 Drawing
28	MQ18008Q 2.702kg/m	盖板配JM14054A 	37	MQ18008B 4.044kg/m	套芯配MQ18002B 	46	JM15587A 0.760kg/m	
29	MQ18008F 2.581kg/m		38	MQ18008D 2.511kg/m		47	JM15587B 1.403kg/m	
30	MQ18008N 4.532kg/m	盖板配JM16044 	39	MQ18008J 3.278kg/m		48	JM15587C 1.284kg/m	
31	MQ18008R 2.439kg/m	盖板配JM14054A 	40	MQ18008G 2.362kg/m		49	JM15588 1.025kg/m	角码配JM5004A
32	MQ18008S 3.567kg/m	盖板配MQ18007D 	41	JM14054A 0.249kg/m		50	JM15588A 1.213kg/m	角码配JM5004A
33	MQ18008FA 2.728kg/m		42	MQ18055 0.252kg/m		51	JM15588B 1.212kg/m	角码配JM5004A
34	MQ18008Q 2.702kg/m	盖板配JM14054A 	43	JM16044 0.287kg/m		52	JM15588C 1.392kg/m	角码配JM5004A
35	MQ18008C 3.353kg/m	盖板配MQ18055 	44	MQ18007D 0.257kg/m		53	JM15588D 1.080kg/m	角码配JM5004A
36	MQ18008CA 2.619kg/m	盖板配MQ18055 	45	JM15587 1.023kg/m		54	MQ18001R 2.030kg/m	

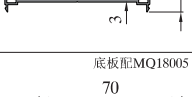
图中所示型材截面、装配、编号、尺寸及重量仅供参考。如有疑问，请向本公司查询。
Information above just for your reference. Please contact us if you have any questions, Thank you!

图中所示型材截面、装配、编号、尺寸及重量仅供参考。如有疑问，请向本公司查询。
Information above just for your reference. Please contact us if you have any questions, Thank you!

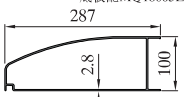
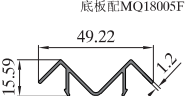
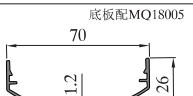
序号 S/N	型号理论重量 JMA Code & KG/M	型材图 Drawing	序号 S/N	型号理论重量 JMA Code & KG/M	型材图 Drawing	序号 S/N	型号理论重量 JMA Code & KG/M	型材图 Drawing
55	MQ18003 0.218kg/m		64	MQ18006A 0.517kg/m		73	MQ18006J 0.474kg/m	
56	MQ18004 0.069kg/m		65	MQ18006B 0.953kg/m		74	MQ18006K 1.068kg/m	
57	MQ18005 0.632kg/m	装饰盖配MQ18006 	66	MQ18006C 0.694kg/m		75	MQ18006L 1.314kg/m	
58	MQ18005C 1.480kg/m		67	MQ18006E 0.474kg/m	底板配MQ18005 	76	MQ18006M 0.631kg/m	底板配MQ18005 
59	MQ18005D 0.665kg/m		68	MQ18006F 0.497kg/m	底板配MQ18005 	77	MQ18006N 0.544kg/m	底板配MQ18005 
60	MQ18005E 1.636kg/m	装饰盖配MQ18006U 	69	MQ18006G 0.404kg/m	底板配MQ18005 	78	MQ18006P 0.653kg/m	底板配MQ18005 
61	MQ18005F 0.468kg/m	装饰盖配MQ18006X 	70	MQ18006H 1.454kg/m	底板配MQ18005 	79	MQ18006KA 0.982kg/m	70 底板配MQ18005 
62	MQ18005G 1.206kg/m	装饰盖配MQ18006Z 	71	MQ18006D 1.642kg/m	底板配MQ18005 	80	MQ18006R 0.480kg/m	底板配MQ18005D 
63	MQ18006 0.393kg/m	底板配MQ18005 	72	MQ18006Q 1.621kg/m	底板配MQ18005D 	81	MQ18006W 2.037kg/m	底板配MQ18005 

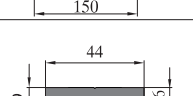
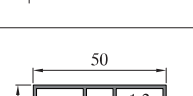
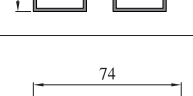
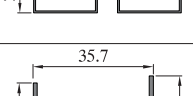
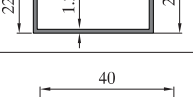
序号 S/N	型号理论重量 JMA Code & KG/M	型材图 Drawing	序号 S/N	型号理论重量 JMA Code & KG/M	型材图 Drawing	序号 S/N	型号理论重量 JMA Code & KG/M	型材图 Drawing
82	MQ18006U 5.949kg/m	底板配MQ18005E 	91			100		
83	MQ18006X 0.320kg/m	底板配MQ18005F 	92			101		
84	MQ18006Y 0.411kg/m	底板配MQ18005 	93			102		
85	MQ18006Z 3.096kg/m	底板配MQ18005G 	94			103		
86	MQ180015 0.860kg/m		95			104		
87	MQ18007A 0.564kg/m		96			105		
88	MQ18007B 0.656kg/m		97			106		
89	MQ18007 0.284kg/m		98			107		
90	JM15589 0.288kg/m		99			108		

图中所示型材截面、装配、编号、尺寸及重量仅供参考。如有疑问，请向本公司查询。
 Information above just for your reference. Please contact us if you have any questions, Thank you!

图中所示型材截面、装配、编号、尺寸及重量仅供参考。如有疑问，请向本公司查询。
 Information above just for your reference. Please contact us if you have any questions, Thank you!

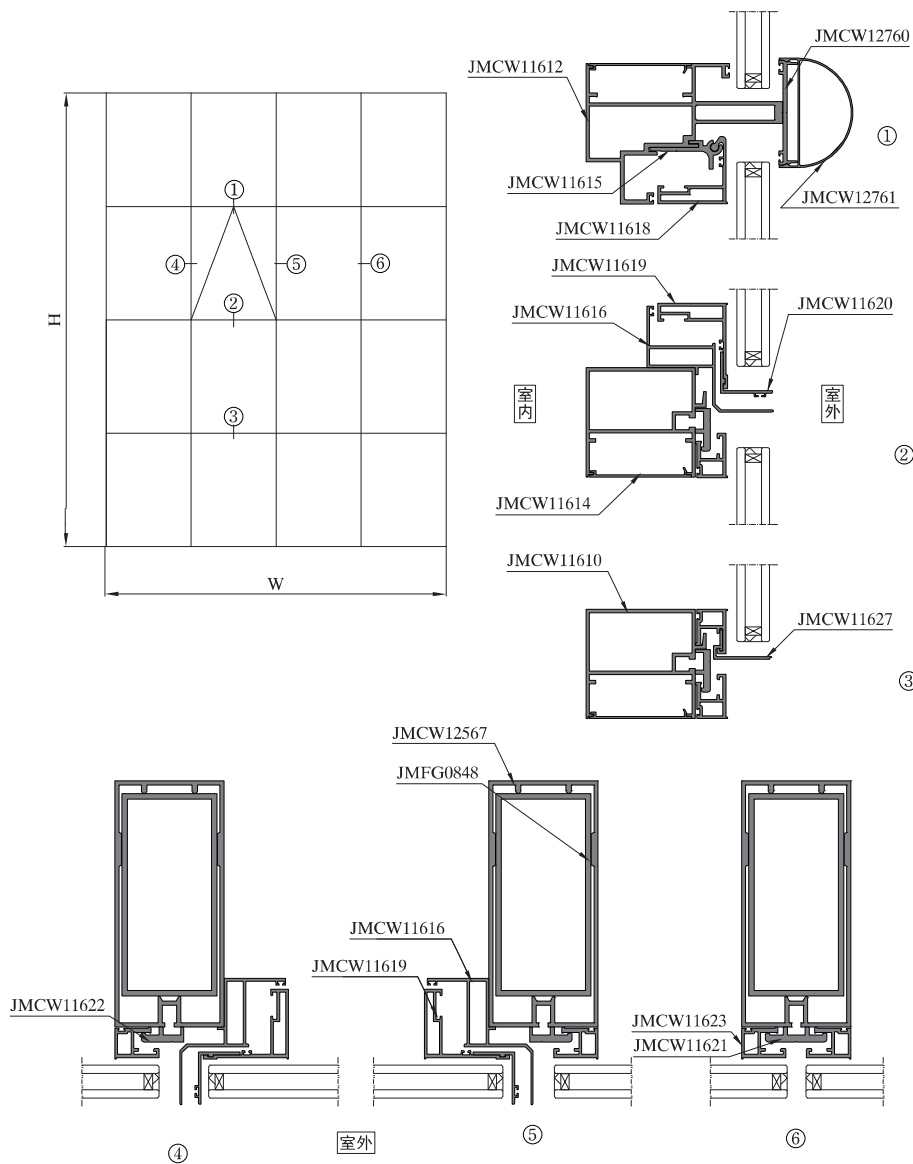

序号 S/N	型号理论重量 JMA Code & KG/M	型材图 Drawing	序号 S/N	型号理论重量 JMA Code & KG/M	型材图 Drawing	序号 S/N	型号理论重量 JMA Code & KG/M	型材图 Drawing
1	JMFG004730 3.758kg/m		10	JMCW11829 2.549kg/m		19	JMCW11620 0.431kg/m	
2	JMCW17377 4.576kg/m		11	JMCW11610 2.644kg/m		20	JMCW11621 0.784kg/m	
3	JMCW12567 5.232kg/m		12	JMCW11613 3.964kg/m		21	JMCW11622 0.552kg/m	
4	JMCW11609 6.742kg/m		13	JMCW11612 4.396kg/m		22	JMCW11623 0.713kg/m	
5	JMCW17776 5.526kg/m		14	JMCW11614 0.372kg/m		23	JMCW11624 0.859kg/m	
6	JMCW17775 2.658kg/m		15	JMCW11615 0.707kg/m		24	JMCW12759 0.923kg/m	
7	MQ80367 3.445kg/m		16	JMCW11616 1.328kg/m		25	JMCW11627 0.387kg/m	
8	JMFG0848 4.908kg/m		17	JMCW11618 1.139kg/m		26	JMCW12760 0.831kg/m	
9	JMFG0850 5.212kg/m		18	JMCW11619 1.112kg/m		27	JMCW12761 0.835kg/m	

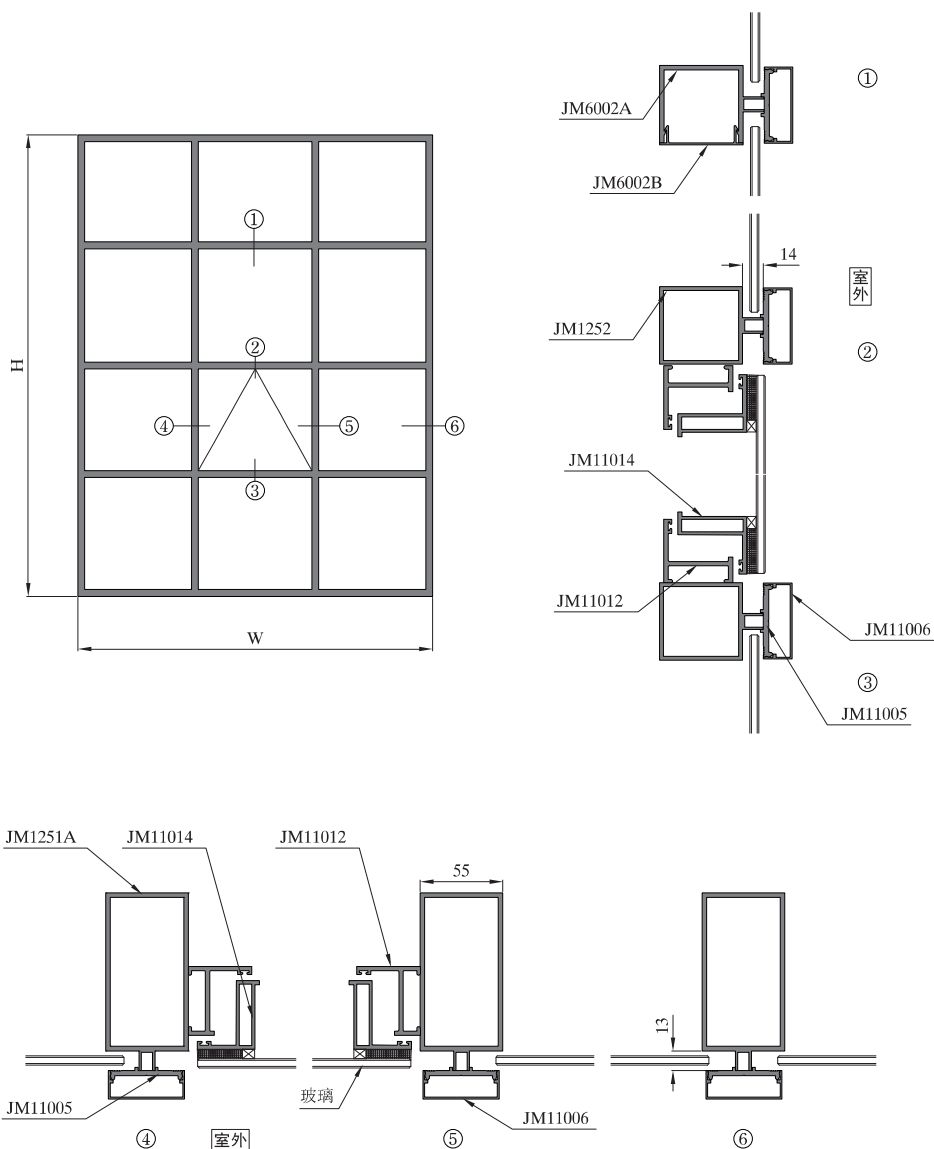

序号 S/N	型号理论重量 JMA Code & KG/M	型材图 Drawing	序号 S/N	型号理论重量 JMA Code & KG/M	型材图 Drawing	序号 S/N	型号理论重量 JMA Code & KG/M	型材图 Drawing
1	JM1251A 2.840kg/m	套芯配JM1250 105 55 3 10.5 118	10	JM1252A 1.305kg/m	盖板配JM6002E 55 51.5 2 68	19	JM6001 0.935kg/m	44 1.5 67
2	JM1251B 2.233kg/m	92 55 2.5 10.5 106	11	JM1253 1.914kg/m	50 2.5 76	20	JM6002 1.907kg/m	51.5 3 55.5 69.5
3	JM1251C 2.814kg/m	套芯配JM1250 105 55 3 10.5 115	12	JM1253A 1.285kg/m	49.3 46.5 1.4 75 100	21	JM6002A 1.485kg/m	盖板配JM6002B 69.5 55.5 3 51.5
4	JM1251D 3.810kg/m	压板配JM11005 130 55.5 3.5 10 144	13	JM1253B 1.244kg/m	49.3 46.5 1.4 77.2 95	22	JM6002B 0.311kg/m	12.8 55.5 1.3
5	JM1251E 1.918kg/m	套芯配JM1250 103 53.2 2 10.5 116	14	JM1254 0.585kg/m	35 1.4 28	23	JM6002C 2.019kg/m	51.5 3 55.5 75.5
6	JM1250 2.029kg/m	2.5 48.7 98.5	15	JM1254A 1.302kg/m	50 1.4 118.6	24	JM6002D 1.540kg/m	盖板配W165-8G-A 60 60 70
7	JM1250C 2.502kg/m	3 50.9 100.7	16	JM1254B 1.261kg/m	50 1.4 113.6	25	LBM12051 2.280kg/m	2 4 50 120
8	JM1250D 3.279kg/m	47.9 3.5 122.4	17	JM1255 0.374kg/m	32 7	26	LBM12051A 3.009kg/m	套芯配LBM12051B 50 4 120
9	JM1252 1.642kg/m	51.5 10.5 55 69	18	JM1256 0.157kg/m	34.4 1.2 7	27	LBM12051B 2.610kg/m	112.7 3 43.7

图中所示型材截面、装配、编号、尺寸及重量仅供参考。如有疑问，请向本公司查询。
Information above just for your reference. Please contact us if you have any questions, Thank you!

图中所示型材截面、装配、编号、尺寸及重量仅供参考。如有疑问，请向本公司查询。
Information above just for your reference. Please contact us if you have any questions, Thank you!

序号 S/N	型号理论重量 JMA Code & KG/M	型材图 Drawing	序号 S/N	型号理论重量 JMA Code & KG/M	型材图 Drawing	序号 S/N	型号理论重量 JMA Code & KG/M	型材图 Drawing
28	LBM12052 1.407kg/m	压盖配LBM12066 59.4 43.2 2 46	37	LBM12059 0.507kg/m	28 35 1.2	46		
29	LBM12053 2.306kg/m	套芯配LBM12056 50 4 80	38	LBM12060 1.792kg/m	60 2.5 70	47		
30	LBM12054 1.945kg/m	65 2.55 65	39	LBM12061 1.440kg/m	2 36.5 94	48		
31	LBM12054A 1.580kg/m	65 2 65	40	LBM12062 1.832kg/m	2 70 94	49		
32	LBM12055 1.497kg/m	35 2.55 65	41	LBM12063 2.118kg/m	套芯配LBM12064 3 50 70	50		
33	LBM12055A 1.178kg/m	2.5 30 50	42	LBM12064 1.781kg/m	3 43.6 63.6	51		
34	LBM12056 1.591kg/m	72.7 2.5 43.7	43	LBM12065 2.874kg/m	90 72 3	52		
35	LBM12057 1.579kg/m	套芯配LBM12058 2 50 76	44	LBM12066 0.247kg/m	配LBM12052 (5.63) 58.2 6.6 1.2	53		
36	LBM12058 1.650kg/m	2.5 45.3 71.3	45	JM6002E 0.281kg/m	12.6 1.3 55	54		

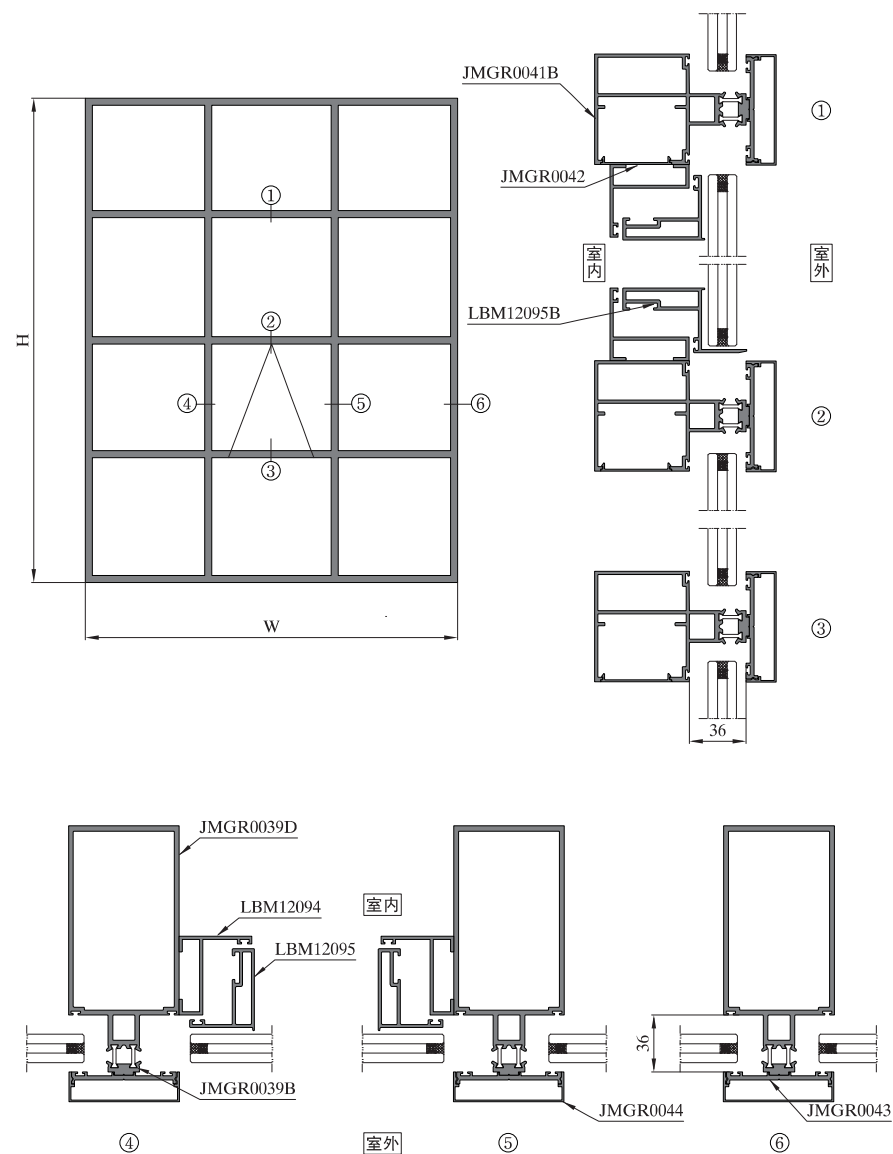

图中所示型材截面、装配、编号、尺寸及重量仅供参考。如有疑问，请向本公司查询。
Information above just for your reference. Please contact us if you have any questions, Thank you!

图中所示型材截面、装配、编号、尺寸及重量仅供参考。如有疑问，请向本公司查询。
Information above just for your reference. Please contact us if you have any questions, Thank you!

序号 S/N	型号理论重量 JMA Code & KG/M	型材图 Drawing	序号 S/N	型号理论重量 JMA Code & KG/M	型材图 Drawing	序号 S/N	型号理论重量 JMA Code & KG/M	型材图 Drawing
1	JMGR0039A JMGR0039B 3.666kg/m		10	JMGR0041A JMGR0039B 3.08kg/m		19	JMGR0044 0.414kg/m	
2	JMGR0039C JMGR0039B 2.148kg/m		11	JMGR0041B JMGR0039B 2.532kg/m		20	JMGR0044A 1.935kg/m	
3	JMGR0039D JMGR0039B 4.285kg/m		12	JMGR0042 0.184kg/m		21	JMGR0044B 0.310kg/m	
4	JMGR0039E JMGR0039B 4.008kg/m		13	JMGR0042A 0.488kg/m		22	JMGR0044C 1.493kg/m	
5	JMGR0039F JMGR0039B 4.172kg/m		14	JMGR0043 0.612kg/m		23	JMGR0044D 1.830kg/m	
6	JMGR0039G JMGR0039B 4.342kg/m		15	JMGR0043A 1.473kg/m		24	JMGR0044E 1.441kg/m	
7	JMGR0039M JMGR0039B 3.88kg/m		16	JMGR0043B 0.416kg/m		25	LBM12094 0.752kg/m	
8	JMGR0040 2.670kg/m		17	JMGR0043C 1.582kg/m		26	LBM12095B 1.108kg/m	
9	JMGR0040A 2.947kg/m		18	JMGR0043D 1.167kg/m		27	LBM12095 0.948kg/m	

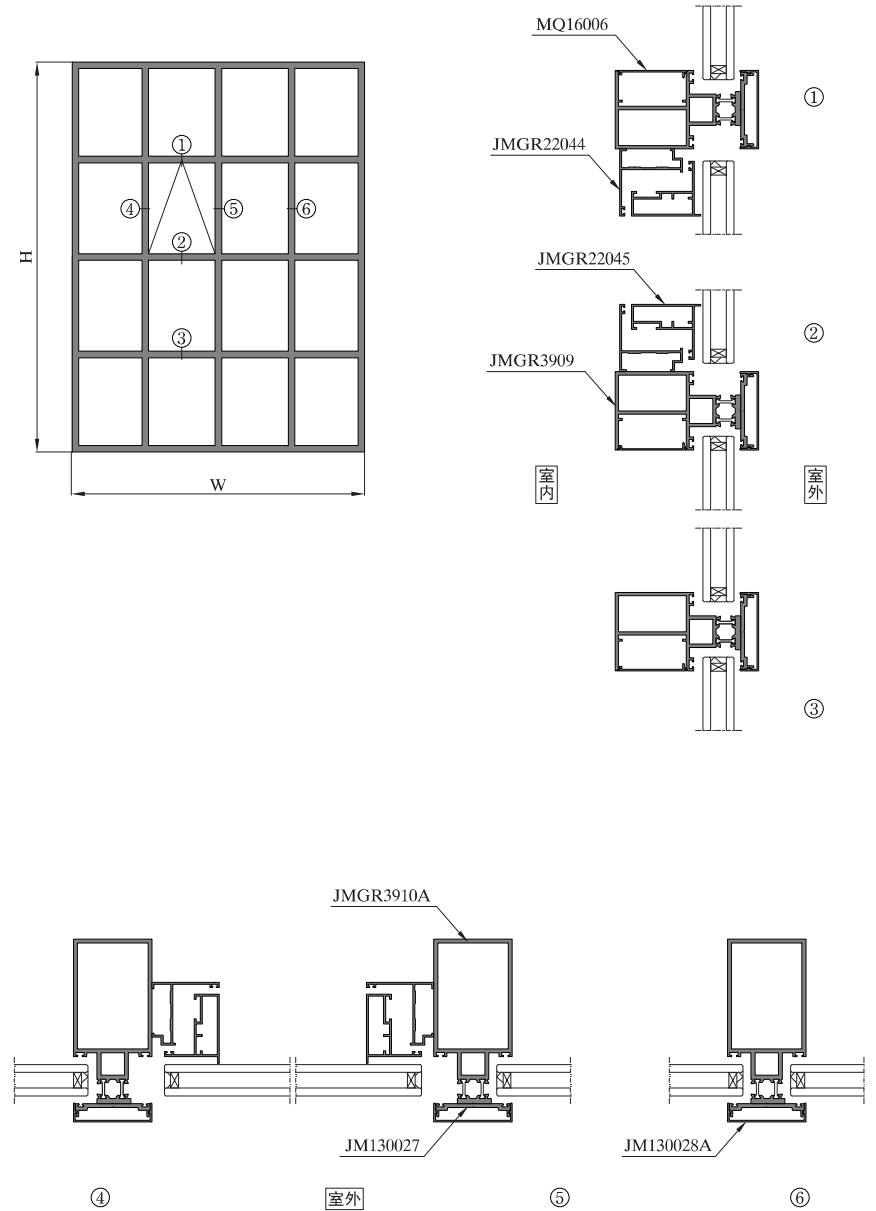

图中所示型材截面、装配、编号、尺寸及重量仅供参考。如有疑问，请向本公司查询。
Information above just for your reference. Please contact us if you have any questions, Thank you!

图中所示型材截面、装配、编号、尺寸及重量仅供参考。如有疑问，请向本公司查询。
Information above just for your reference. Please contact us if you have any questions, Thank you!

序号 S/N	型号理论重量 JMA Code & KG/M	型材图 Drawing	序号 S/N	型号理论重量 JMA Code & KG/M	型材图 Drawing	序号 S/N	型号理论重量 JMA Code & KG/M	型材图 Drawing
1	主梁 JMGR0123 JMGR3910 3.869kg/m		10	开启框 JMGR22044 0.602kg/m		19		
2	主梁 JMGR0123 JMGR3910A 3.613kg/m		11	开启扇 JMGR22045 0.779kg/m		20		
3	主梁 JMGR0123 JMGR3911 3.681kg/m		12			21		
4	套芯 MQ17082 3.076kg/m		13			22		
5	套芯 MQ16022B 2.063kg/m		14			23		
6	横梁 JMGR0123 JMGR3909 2.723kg/m		15			24		
7	横梁盖板 MQ16006 0.200kg/m		16			25		
8	底板 JM130027 0.599kg/m		17			26		
9	盖板 JM130028A 0.337kg/m		18			27		

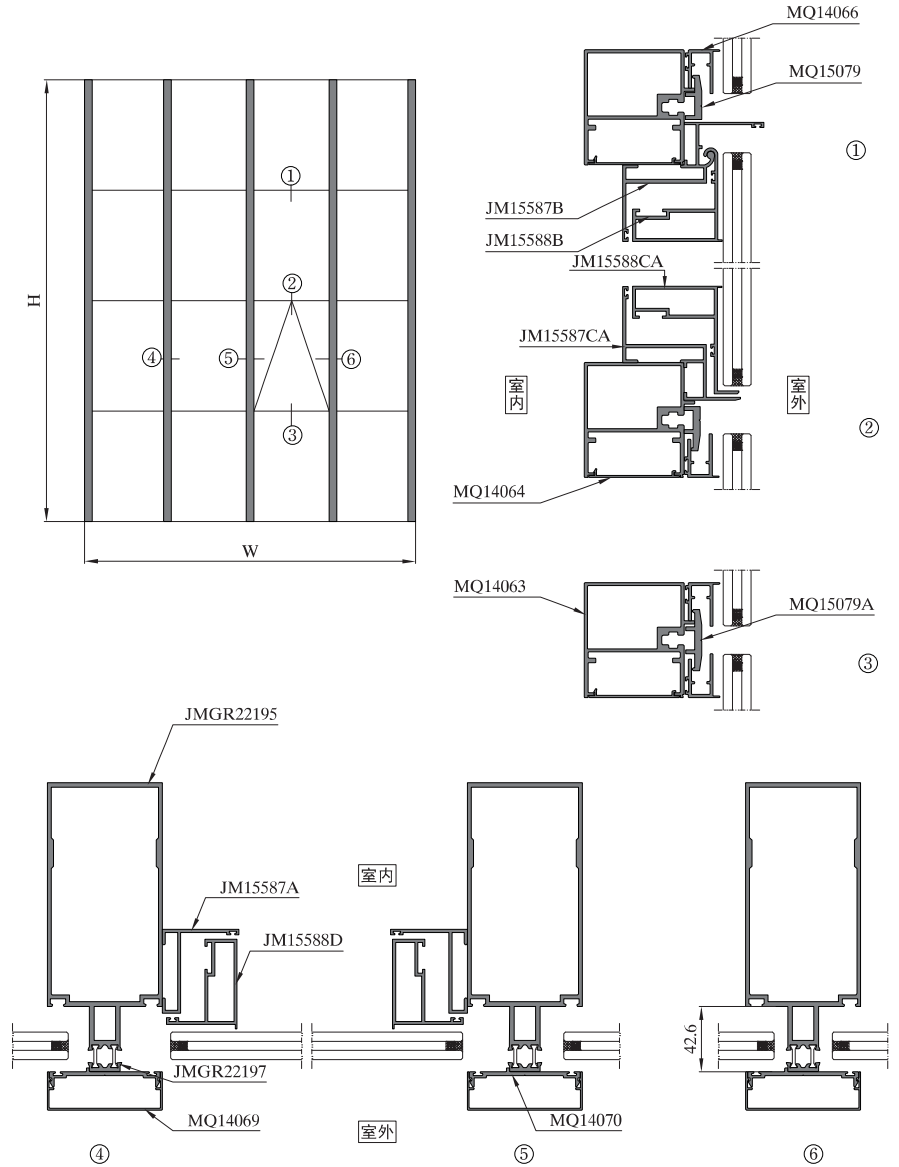

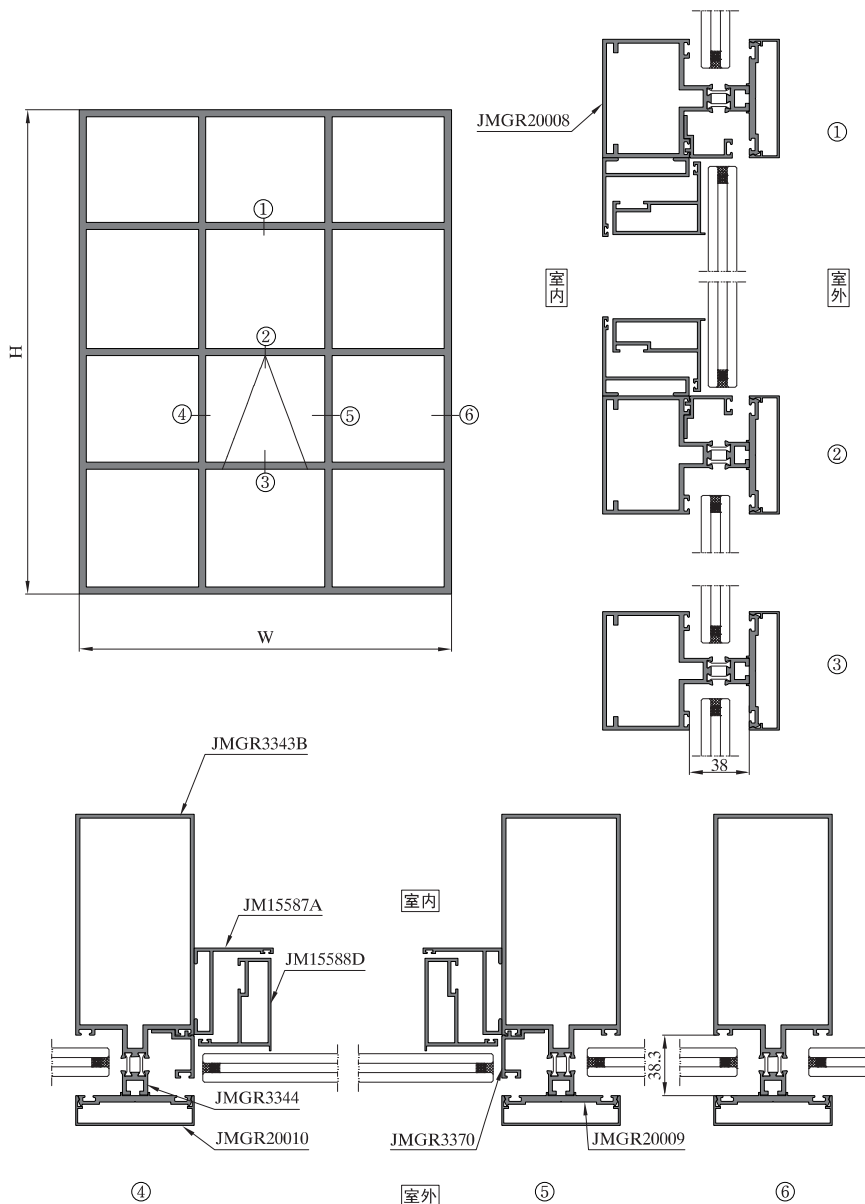

序号 S/N	型号理论重量 JMA Code & KG/M	型材图 Drawing	序号 S/N	型号理论重量 JMA Code & KG/M	型材图 Drawing	序号 S/N	型号理论重量 JMA Code & KG/M	型材图 Drawing
1	JMGR3343A JMGR3344 4.437kg/m		10	JMGR22206 4.495kg/m		19	JM15587B 1.403kg/m	
2	JMGR3343B JMGR3344 4.026kg/m		11	MQ14062 4.274kg/m		20	JM15587CA 1.180kg/m	
3	JMGR20101 JMGR3344 5.047kg/m		12	MQ14062A 3.369kg/m		21	JM15588 1.025kg/m	
4	JMGR22194 JMGR22197 4.560kg/m		13	MQ14063 2.145kg/m		22	JM15588AA 1.146kg/m	
5	JMGR22195 JMGR22197 4.538kg/m		14	JMGR20008 JMGR3344 2.829kg/mz		23	JM15588B 1.212kg/m	
6	MQ14061 3.376kg/m		15	JMGR3354 2.111kg/m		24	JM15588CA 1.304kg/m	
7	MQ14061A 2.904kg/m		16	MQ14064 0.251kg/m		25	JM15588D 1.08kg/m	
8	JMGR3348A 3.351kg/m		17	JM15587 1.023kg/m		26	JM15589 0.288kg/m	
9	JMGR20102 3.362kg/m		18	JM15587A 0.760kg/m		27	JMGR20009 0.822kg/m	

序号 S/N	型号理论重量 JMA Code & KG/M	型材图 Drawing	序号 S/N	型号理论重量 JMA Code & KG/M	型材图 Drawing	序号 S/N	型号理论重量 JMA Code & KG/M	型材图 Drawing
28	MQ14070 0.631kg/m		37	MQ15079 0.451kg/m		46		
29	JMGR20023 1.319kg/m		38	MQ15079A 0.585kg/m		47		
30	JMGR20010 0.485kg/m		39	MQ14066 0.433kg/m		48		
31	MQ14069 0.458kg/m		40	JM5004A 2.354kg/m		49		
32	JMGR20024 1.467kg/m		41			50		
33	JMGR3370 0.418kg/m		42			51		
34	JMGR3370A 0.396kg/m		43			52		
35	MQ13095 0.699kg/m		44			53		
36	MQ13095A 0.519kg/m		45			54		

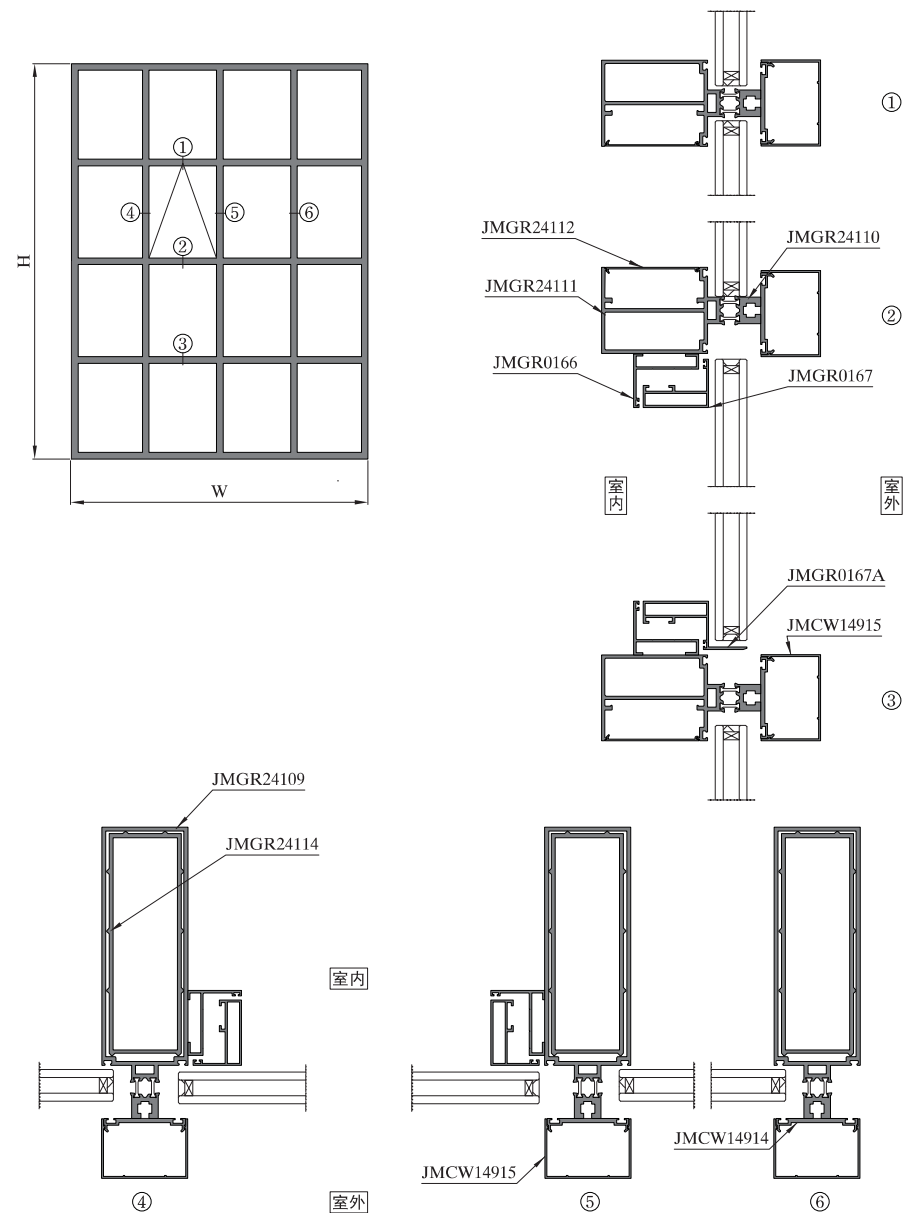

图中所示型材截面、装配、编号、尺寸及重量仅供参考。如有疑问，请向本公司查询。
Information above just for your reference. Please contact us if you have any questions, Thank you!

图中所示型材截面、装配、编号、尺寸及重量仅供参考。如有疑问，请向本公司查询。
Information above just for your reference. Please contact us if you have any questions, Thank you!

序号 S/N	型号理论重量 JMA Code & KG/M	型材图 Drawing	序号 S/N	型号理论重量 JMA Code & KG/M	型材图 Drawing	序号 S/N	型号理论重量 JMA Code & KG/M	型材图 Drawing
1	JMGR24109 JMGR24110 5.385kg/m	套芯配JMGR24114 220.2 180 14.8 6.5 170.4 20 JMGR24109 JMGR24110	10	JMGR0166 0.599kg/m	40.5 1.8 49	19		
2	JMGR24113 JMGR24110 3.492kg/m	套芯配JMGR24115 140.2 100 14.8 6.5 2.5 JMGR24113 JMGR24110	11	JMGR0167 0.761kg/m	角码配JM3824 36.5 1.6 9.1 49.5	20		
3	JMGR21491 JMLY0015 4.041kg/m	套芯配JMGR2878 180 136.5 14.8 6.5 2.5 5.8 145 18 JMGR21491 JMLY0015	12	JMGR0167A 0.927kg/m	角码配JM3824 78.5 36.5 1.6 9.1	21		
4	JMGR24114 3.835kg/m	58.5 2.5 169.9	13	JMCW14914 0.592kg/m	61.6 10.1 3	22		
5	JMGR24115 2.497kg/m	90.9 59.5 3	14	JMCW14915 0.679kg/m	45 1.5 65	23		
6	JMGR2878 3.420kg/m	5 58.5 134.2	15	JMCW14916 1.041kg/m	5.5 1.5 65	24		
7	JMGR24111 JMGR24110 3.378kg/m	盖板配JMGR24112 120.2 80 14.8 6.5 6 JMGR24111 JMGR24110	16	JMCW14917 1.217kg/m	7.5 1.5 65	25		
8	JMGR21492 JMLY0015 2.636kg/m	盖板配JM14054A 100 65 14.8 6.5 2 JMGR21492 JMLY0015	17	JM14054A 0.249kg/m	56.3 1.2	26		
9	JMGR24112 0.248kg/m	4.5 1.1 71	18	JM3824 1.331kg/m	40 40 6.8	27		

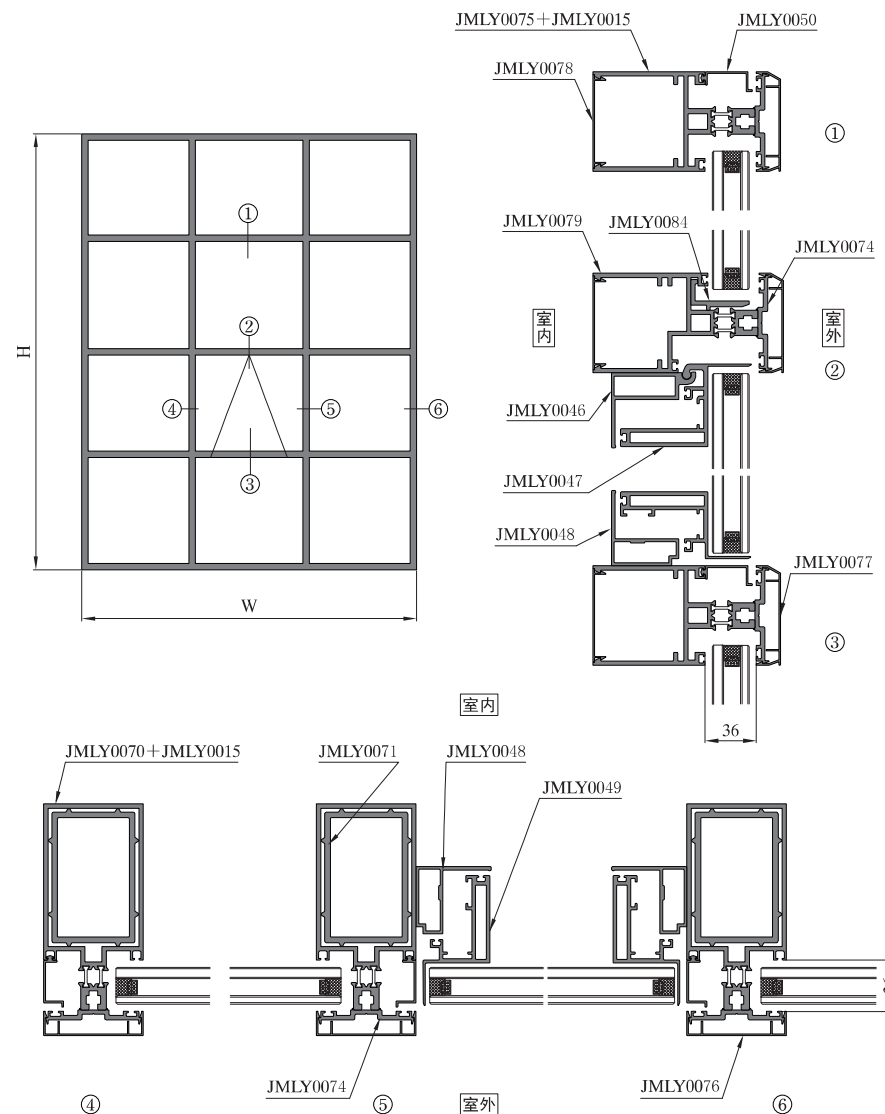

序号 S/N	型号理论重量 JMA Code & KG/M	型材图 Drawing	序号 S/N	型号理论重量 JMA Code & KG/M	型材图 Drawing	序号 S/N	型号理论重量 JMA Code & KG/M	型材图 Drawing
1	JMLY0070 JMLY0015 4.050kg/m		10	JMLY0075 JMLY0015 3.430kg/m		19	JMLY0074 0.729kg/m	
2	JMLY0070A JMLY0015 4.514kg/m	套芯配JMLY0071A 	11	JMLY0075A JMLY0015 3.956kg/m	JMLY0075A 盖板配MO18055 	20	JMLY0076 0.400kg/m	
3	JMLY0070B JMLY0015 4.992kg/m	套芯配JMLY0071B 	12	JMLY0075B JMLY0015 3.720kg/m	JMLY0075B 盖板配MO18055 	21	JMLY0076B 0.706kg/m	
4	JMLY0070M JMLY0015 4.778kg/m		13	JMLY0079 JMLY0015 3.323kg/m		22	JMLY0077 0.395kg/m	
5	JMLY0070Z JMLY0015 5.216kg/m	套芯配JMLY0071E 	14	MO18055 0.252kg/m		23	JMLY0140 0.855kg/m	
6	JMLY0111 JMLY0015 4.861kg/m	套芯配JMLY0071 	15	JMLY0071 3.482kg/m		24	JMLY0112 1.488kg/m	
7	JMLY0070S JMLY0015 3.506kg/m		16	JMLY0071A 4.102kg/m		25	JMLY0113 1.340kg/m	
8	JMLY0070X JMLY0015 2.127kg/m		17	JMLY0071B 3.739kg/m		26	JMLY0046 1.320kg/m	角码配JMGR50B05
9	JMLY0070Y JMLY0015 2.436kg/m		18	JMLY0071E 4.765kg/m		27	JMLY0047 2.016kg/m	角码配JMGR5257

序号 S/N	型号理论重量 JMA Code & KG/M	型材图 Drawing	序号 S/N	型号理论重量 JMA Code & KG/M	型材图 Drawing	序号 S/N	型号理论重量 JMA Code & KG/M	型材图 Drawing
28	JMLY0048 1.012kg/m	角码配JMGR50B05 	37			46		
29	JMLY0049 1.684kg/m	角码配JMGR5257 	38			47		
30	JMLY0050 0.238kg/m		39			48		
31	JMLY0078 0.282kg/m		40			49		
32	JMLY0084 0.602kg/m		41			50		
33	JMGR50B05 3.667kg/m		42			51		
34	JMGR5257 1.723kg/m		43			52		
35			44			53		
36			45			54		

图中所示型材截面、装配、编号、尺寸及重量仅供参考。如有疑问，请向本公司查询。
 Information above just for your reference. Please contact us if you have any questions, Thank you!

图中所示型材截面、装配、编号、尺寸及重量仅供参考。如有疑问，请向本公司查询。
 Information above just for your reference. Please contact us if you have any questions, Thank you!

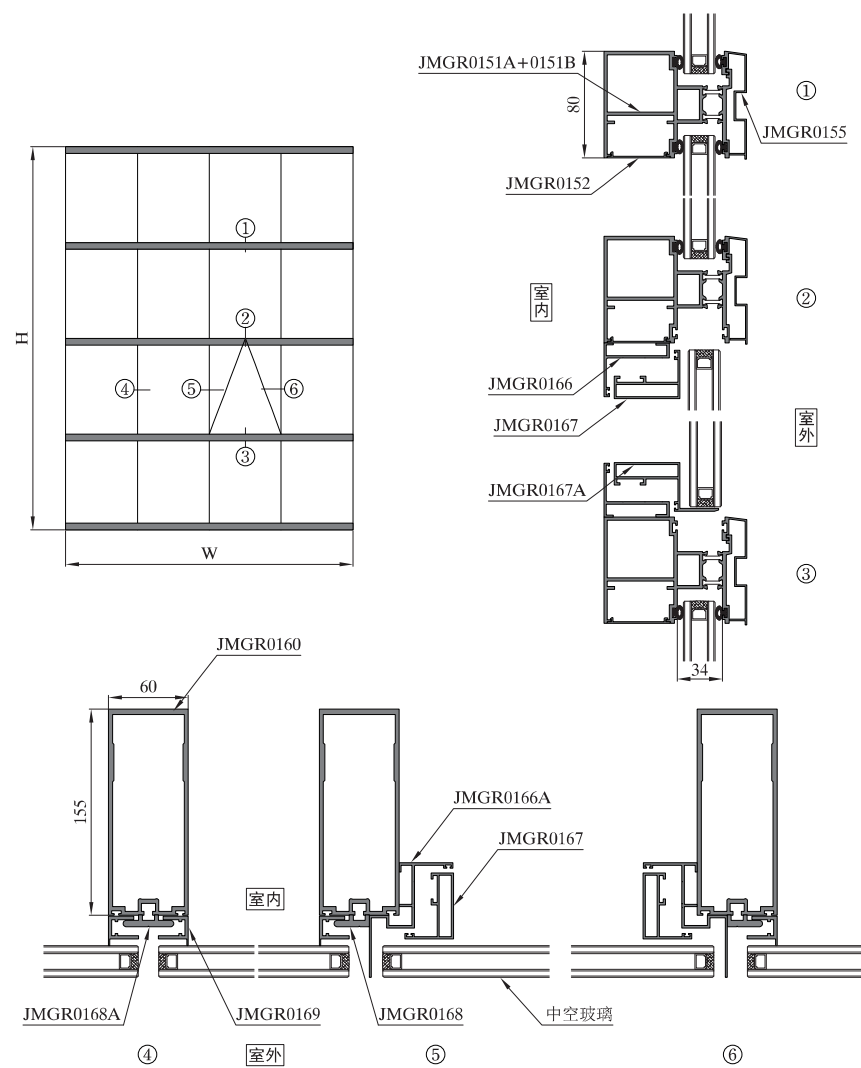
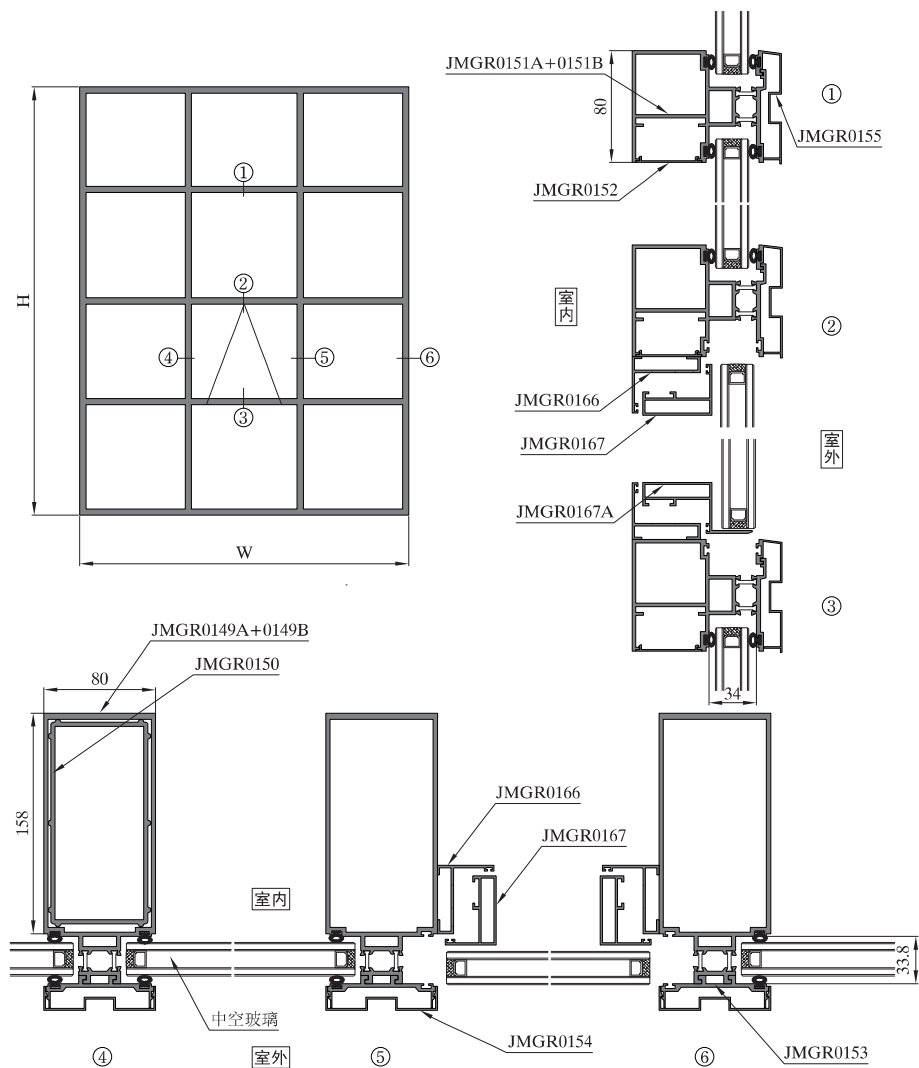

图中所示型材截面、装配、编号、尺寸及重量仅供参考。如有疑问，请向本公司查询。
Information above just for your reference. Please contact us if you have any questions, Thank you!

图中所示型材截面、装配、编号、尺寸及重量仅供参考。如有疑问，请向本公司查询。
Information above just for your reference. Please contact us if you have any questions, Thank you!

序号 S/N	型号理论重量 JMA Code & KG/M	型材图 Drawing	序号 S/N	型号理论重量 JMA Code & KG/M	型材图 Drawing	序号 S/N	型号理论重量 JMA Code & KG/M	型材图 Drawing
1	JMGR0149A JMGR0149B 5.559kg/m		10	JMGR0150E 4.356kg/m		19	JMGR0153B 1.189kg/m	
2	JMGR0149B JMGR0149C 5.402kg/m		11	JMGR0151A JMGR0151B 3.384kg/m		20	JMGR0153C 0.957kg/m	
3	JMGR0149D JMGR0149B 4.698kg/m		12	JMGR0151A JMGR0151C 3.447kg/m		21	JMGR0154 0.467kg/m	
4	JMGR0149L JMGR0149B 4.700kg/m		13	JMGR0151D JMGR0149B 3.396kg/m		22	JMGR0154A 1.828kg/m	
5	JMGR0149M JMGR0149B 5.875kg/m		14	JMGR0151G JMGR0149B 3.074kg/m		23	JMGR0154B 2.821kg/m	
6	JMGR0149P JMGR0149B 4.433kg/m		15	JMGR0152 0.193kg/m		24	JMGR0154C 3.081kg/m	
7	JMGR0150 3.829kg/m		16	JMGR0152A 0.235kg/m		25	JMGR0154D 0.410kg/m	
8	JMGR0150A 3.486kg/m		17	JMGR0153 0.899kg/m		26	JMGR0154E 2.360kg/m	
9	JMGR0150B 2.931kg/m		18	JMGR0153A 1.471kg/m		27	JMGR0154F 0.645kg/m	

序号 S/N	型号理论重量 JMA Code & KG/M	型材图 Drawing	序号 S/N	型号理论重量 JMA Code & KG/M	型材图 Drawing	序号 S/N	型号理论重量 JMA Code & KG/M	型材图 Drawing
28	JMGR0154P 1.767kg/m		37	JMGR0158 3.629kg/m		46	JMGR0161B 2.333kg/m	
29	JMGR0154G 0.579kg/m		38	JMGR0159 4.776kg/m		47	JMGR0162 0.422kg/m	
30	JMGR0154L 1.409kg/m		39	JMGR0160 4.231kg/m		48	JMGR0163 2.543kg/m	
31	JMGR0155 0.582kg/m		40	JMGR0160A 4.182kg/m		49	JMGR0163A JMGR0163B 2.715kg/m	
32	JMGR0155A 0.526kg/m		41	JMGR0160B 2.507kg/m		50	JMGR0163E 2.310kg/m	
33	JMGR0155B 2.147kg/m		42	JMGR0160C 4.049kg/m		51	JMGR0165 0.152kg/m	
34	JMGR0155C 1.457kg/m		43	JMGR0160D 2.899kg/m		52	JMGR0165A 0.179kg/m	
35	JMGR0156 0.194kg/m		44	JMGR0161 3.269kg/m		53	JMGR0166 0.599kg/m	
36	JMGR0157 0.471kg/m		45	JMGR0161A 3.162kg/m		54	JMGR0166A 0.962kg/m	

图中所示型材截面、装配、编号、尺寸及重量仅供参考。如有疑问，请向本公司查询。
Information above just for your reference. Please contact us if you have any questions, Thank you!

图中所示型材截面、装配、编号、尺寸及重量仅供参考。如有疑问，请向本公司查询。
Information above just for your reference. Please contact us if you have any questions, Thank you!

序号 S/N	型号理论重量 JMA Code & KG/M	型材图 Drawing	序号 S/N	型号理论重量 JMA Code & KG/M	型材图 Drawing	序号 S/N	型号理论重量 JMA Code & KG/M	型材图 Drawing
55	JMGR0166B 0.989kg/m		64	JMGR0168B 0.607kg/m		73		
56	JMGR0166C 0.625kg/m		65	JMGR0169 0.423kg/m		74		
57	JMGR0167 0.761kg/m		66	JMGR0169B 0.453kg/m		75		
58	JMGR0167A 0.927kg/m		67	JMGR0169C 0.584kg/m		76		
59	JMGR0167B 1.022kg/m		68	JMGR0172 1.363kg/m		77		
60	JMGR0167C 0.808kg/m		69	JMGR0173 0.347kg/m		78		
61	JMGR0167D 0.696kg/m		70	JMGR0174 0.432kg/m		79		
62	JMGR0168 0.449kg/m		71	JM3824 1.331kg/m		80		
63	JMGR0168A 0.610kg/m		72			81		

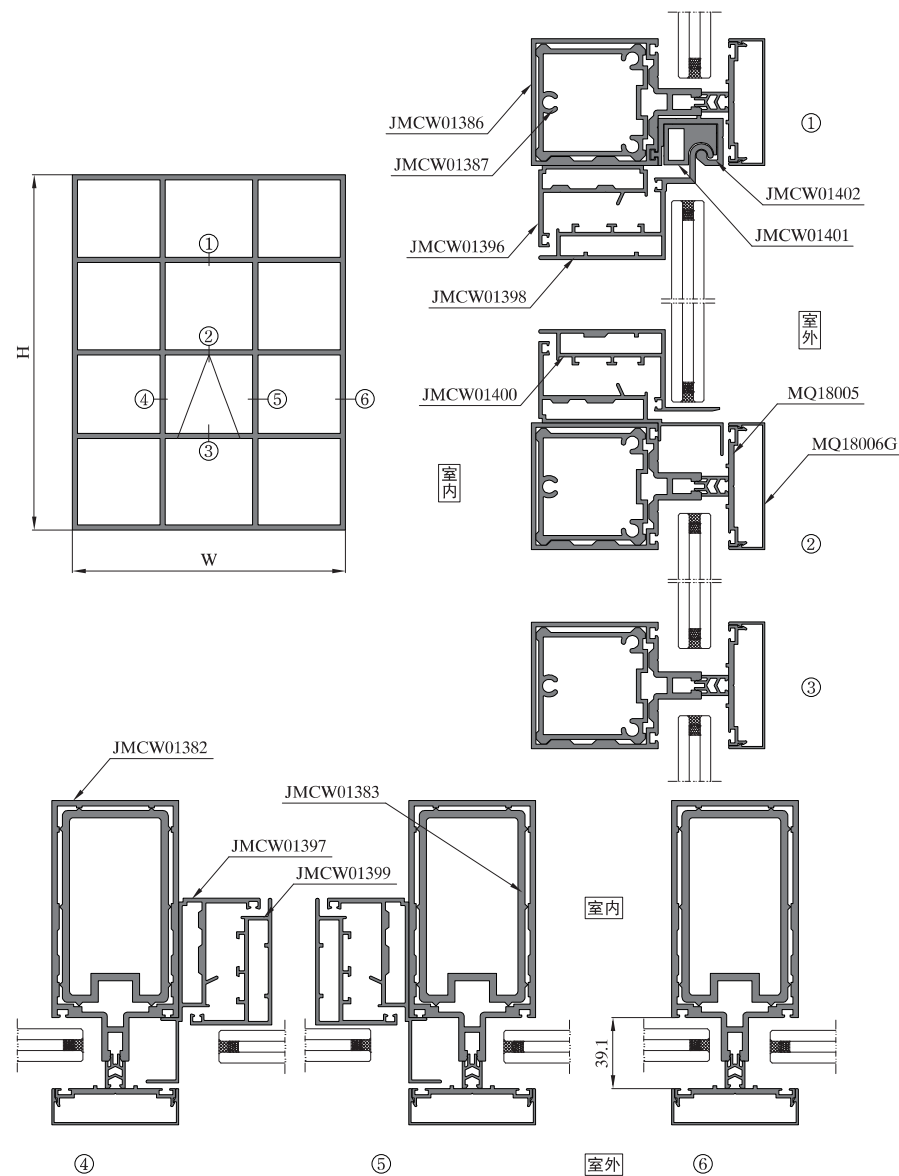

图中所示型材截面、装配、编号、尺寸及重量仅供参考。如有疑问，请向本公司查询。
Information above just for your reference. Please contact us if you have any questions, Thank you!

图中所示型材截面、装配、编号、尺寸及重量仅供参考。如有疑问，请向本公司查询。
Information above just for your reference. Please contact us if you have any questions, Thank you!

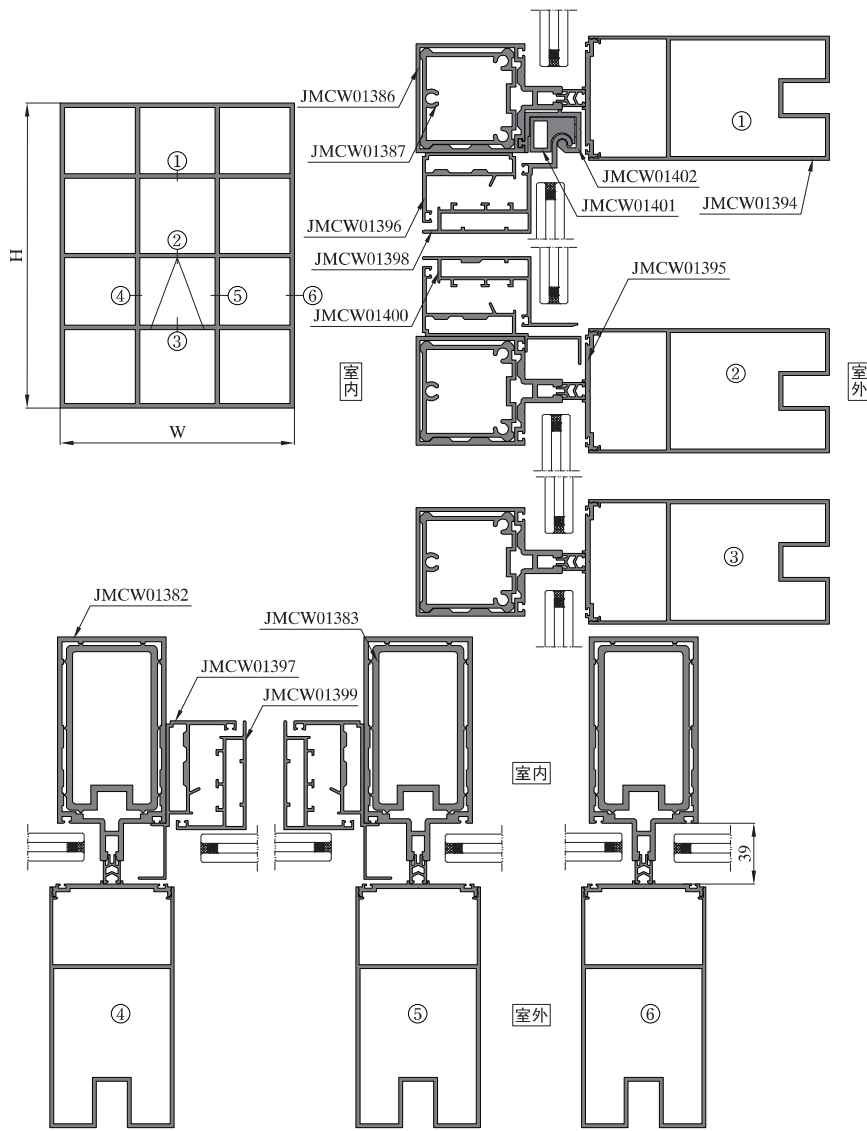

序号 S/N	型号理论重量 JMA Code & KG/M	型材图 Drawing	序号 S/N	型号理论重量 JMA Code & KG/M	型材图 Drawing	序号 S/N	型号理论重量 JMA Code & KG/M	型材图 Drawing
1	JMCW01382 4.128kg/m	芯芯配JMCW01383 120 70 3 144 15 24	10	MQ18002B 2.462kg/m	3 62.4 88.6	19	MQ16004A 0.837kg/m	配MQ16005A (89.36) 21.36 90°
2	JMCW03302 3.441kg/m	芯芯配MQ18002B 95.85 70 119.85 15 24	11	JMCW01387 2.168kg/m	64.5 2.5 61.75	20	MQ16004B 0.969kg/m	配MQ16005B (110.57) 20.67 90°
3	JMCW03301 4.566kg/m	芯芯配JMCW01383 70 3 174 90°	12	JMCW01396 1.215kg/m	60 2 45 9	21	MQ18006G 0.404kg/m	角码配JM3824 70 20 1.2
4	JMCW01386 2.889kg/m	芯芯配JMCW01387 70 2.5 94 24	13	JMCW01397 1.565kg/m	102 2 63 9	22	JMCW01394 3.651kg/m	角码配JM3824 80 155 2.5
5	JMCW01386A 2.494kg/m	芯芯配JMCW01387 70 2 94 24 塑胶条 底板配JMCW01392A 盖板配JMCW01393A	14	JMCW01398 1.658kg/m	角码配JM16054 2.5 63.9 96.4	23	MQ16005A 1.209kg/m	角码配JM16054 68.89 70.22 90° 1.5 (85.19) 112.75
6	JMCW01386C 3.136kg/m	芯芯配JMCW01387 80 2.5 104 11 塑胶条 底板配JMCW01392A 盖板配JMCW01393A	15	JMCW01399 1.250kg/m	角码配JM16054 45 2 70 11	24	MQ16005B 1.247kg/m	角码配JM16054 79.28 94.43 90° 1.5 133.54
7	JMCW01386B 2.054kg/m	芯芯配JMCW01387 77.5 70 2 77.5	16	JMCW01400 1.480kg/m	角码配JM16054 45 2 100 11	25	JMCW01401 1.000kg/m	角码配JM16054 2.5 22.5 29.5
8	JMCW01386D 2.295kg/m	芯芯配JMCW01387 70 2.5 77.5	17	MQ18005 0.632kg/m	66.4 3 10	26	JMCW01402 0.901kg/m	角码配JM16054 40.1 27.5 3
9	JMCW01383 3.994kg/m	4 61.5 109.5	18	JMCW01395 0.762kg/m	10 77	27		

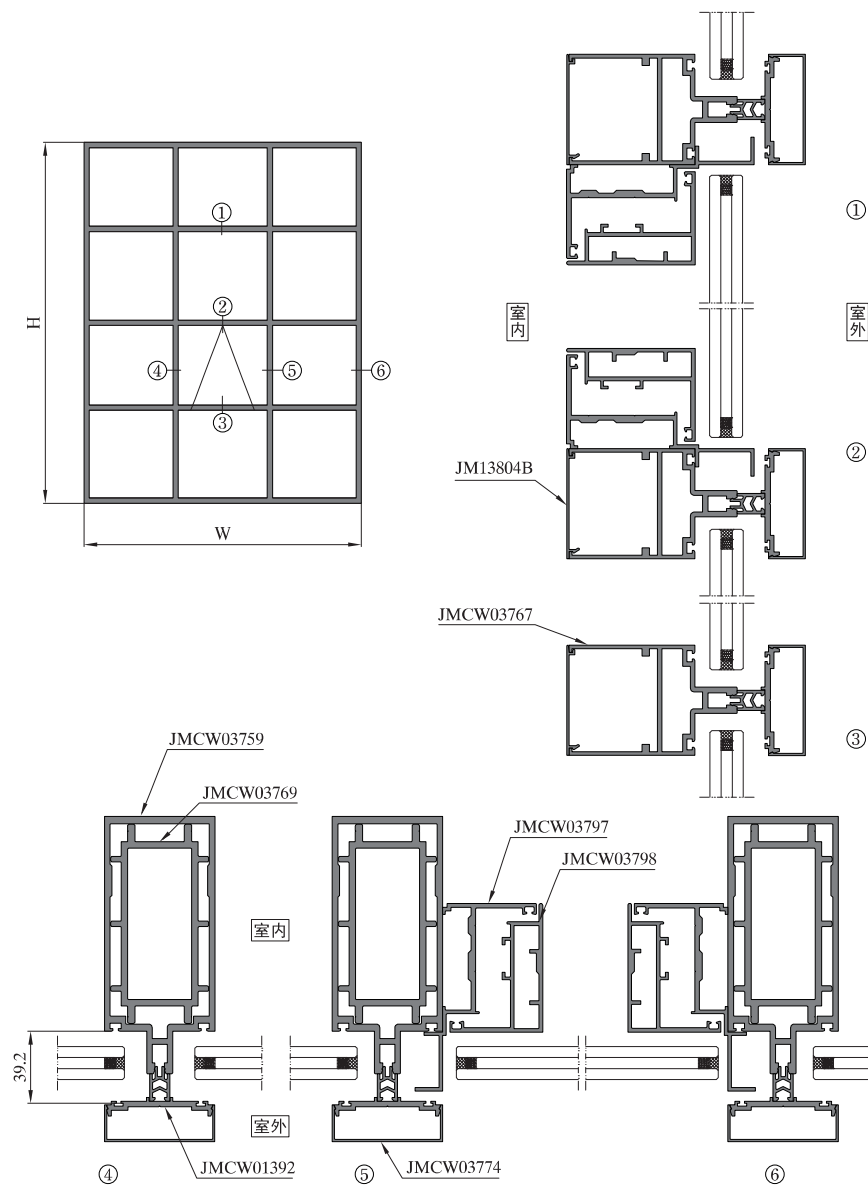
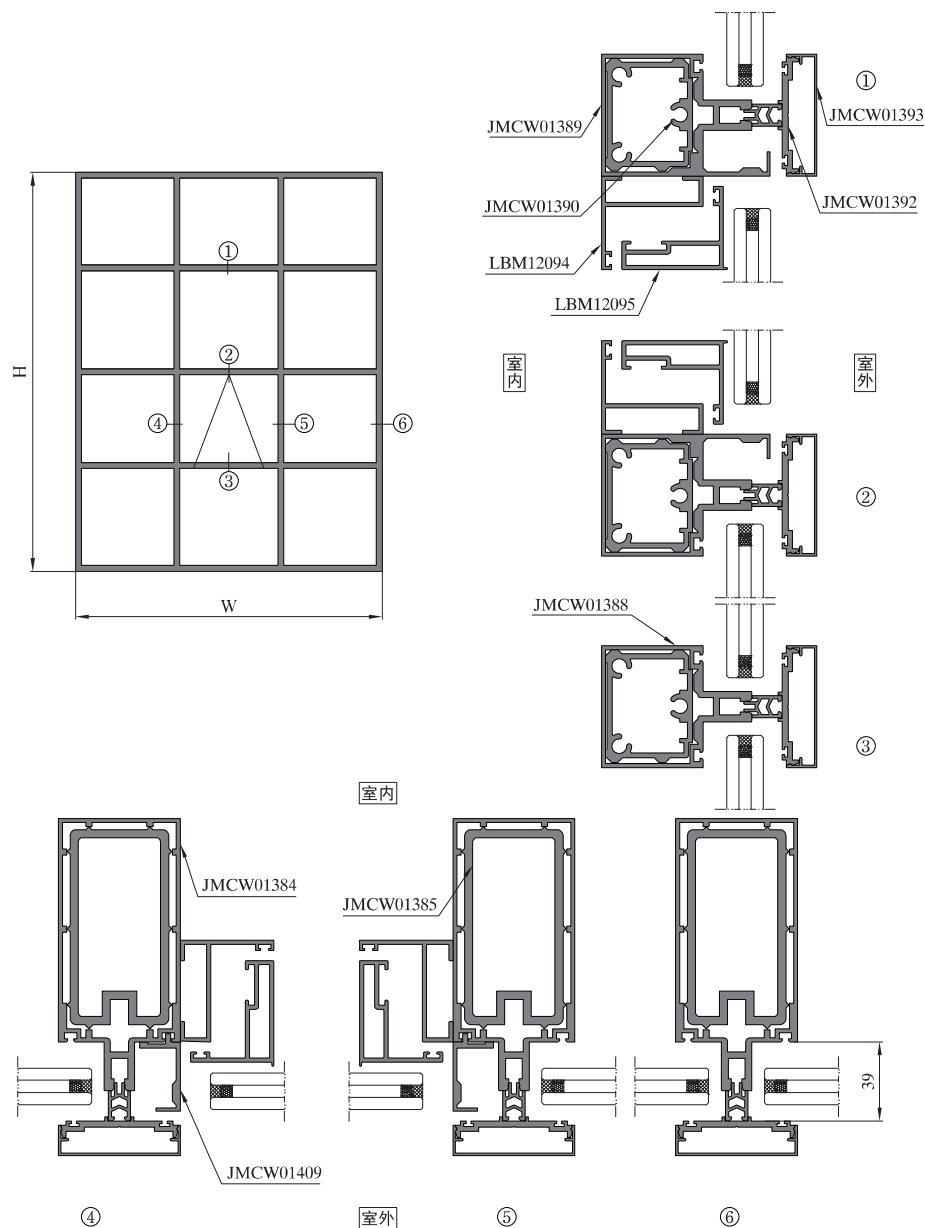

序号 S/N	型号理论重量 JMA Code & KG/M	型材图 Drawing	序号 S/N	型号理论重量 JMA Code & KG/M	型材图 Drawing	序号 S/N	型号理论重量 JMA Code & KG/M	型材图 Drawing
1	JMCW03759 3.914kg/m	套芯配JMCW03769 塑胶条 	10	JMCW01385 3.539kg/m		19	JM13804B 0.246kg/m	横梁配JMCW03767 JMCW03768
2	JMCW03763 4.102kg/m	套芯配JMCW08252 塑胶条 	11	JMCW03770 3.996kg/m		20	JM13804E 0.275kg/m	
3	JMCW01384 2.883kg/m	套芯配JMCW01385 	12	JMCW03771 3.866kg/m		21	JMCW03796 1.469kg/m	
4	JMCW03760 3.745kg/m		13	JMCW01390 1.779kg/m		22	JMCW03797 1.379kg/m	
5	JMCW03761 4.565kg/m	套芯配JMCW03770 	14	JMCW01388 2.037kg/m	套芯配JMCW01390 	23	JMCW03799 1.609kg/m	
6	JMCW03762 4.413kg/m		15	JMCW01389 2.461kg/m	套芯配JMCW01390 	24	JMCW03798 1.355kg/m	角码配GRF8009
7	JMCW03764 3.957kg/m	套芯配JMCW03771 	16	JMCW03766 2.238kg/m	横面板配JM13804E 角铝配JM1014A40 	25	JMCW03800 1.655kg/m	角码配GRF8009
8	JMCW03769 3.285kg/m		17	JMCW03767 2.268kg/m	底板配JM13804B 塑胶条 	26	LBM12094 0.752kg/m	
9	JMCW08252 3.410kg/m		18	JMCW03768 2.502kg/m	底板配JM13804B 塑胶条 	27	LBM12095 0.948kg/m	角码配GRQ5509

序号 S/N	型号理论重量 JMA Code & KG/M	型材图 Drawing	序号 S/N	型号理论重量 JMA Code & KG/M	型材图 Drawing	序号 S/N	型号理论重量 JMA Code & KG/M	型材图 Drawing
28	JMCW01392 0.593kg/m		37	JMCW03792 0.410kg/m		46		
29	JMCW03780 1.144kg/m		38	JMCW03793 0.561kg/m		47		
30	JMCW01393 0.338kg/m		39	JMCW01409 0.461kg/m		48		
31	JMCW03774 0.372kg/m		40	JMCW03790 0.302kg/m		49		
32	JMCW03775 2.958kg/m	面板配JMCW03780 小盖板配JMCW03787 	41	GRF8009 3.525kg/m		50		
33	JMCW03787 0.117kg/m		42	GRQ5509 2.690kg/m		51		
34	JMCW04494 0.524kg/m		43			52		
35	JMCW03794 0.636kg/m		44			53		
36	JMCW03789 0.840kg/m		45			54		

图中所示型材截面、装配、编号、尺寸及重量仅供参考。如有疑问，请向本公司查询。
Information above just for your reference. Please contact us if you have any questions, Thank you!

图中所示型材截面、装配、编号、尺寸及重量仅供参考。如有疑问，请向本公司查询。
Information above just for your reference. Please contact us if you have any questions, Thank you!

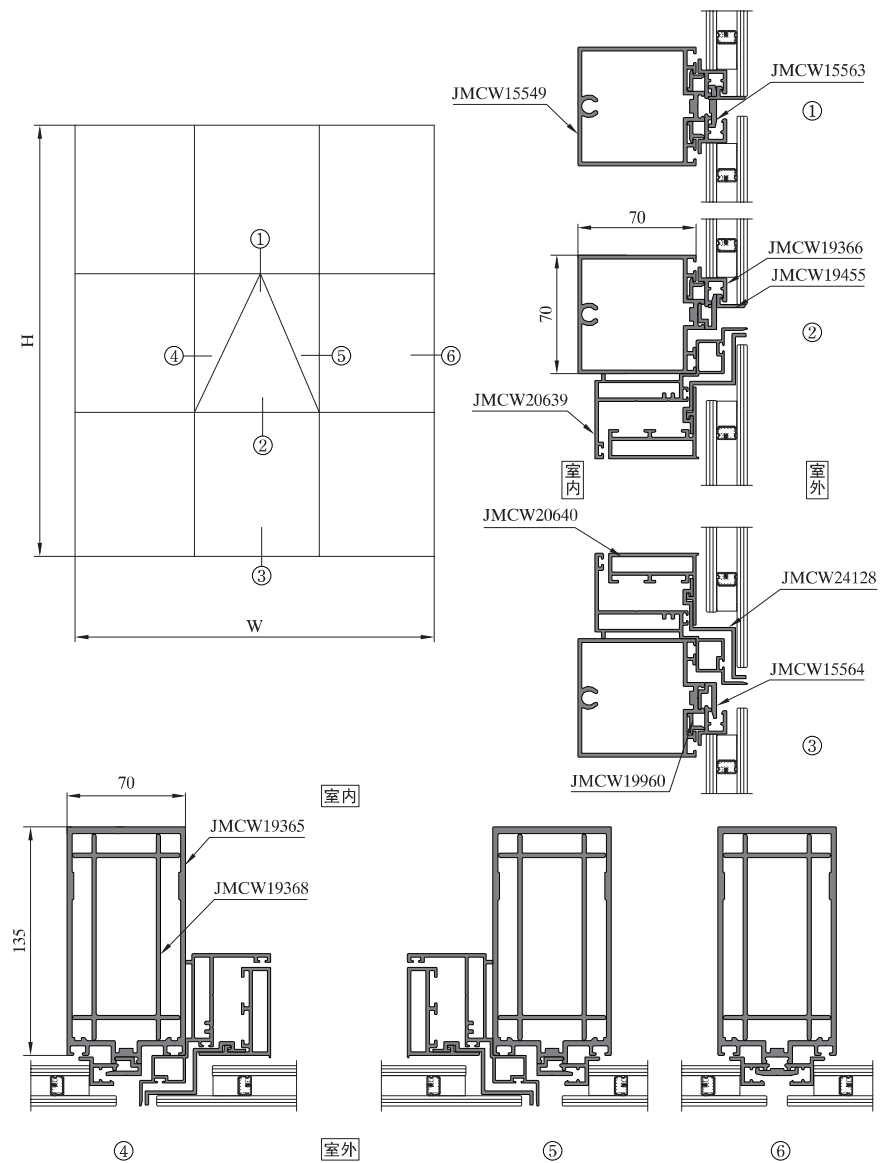
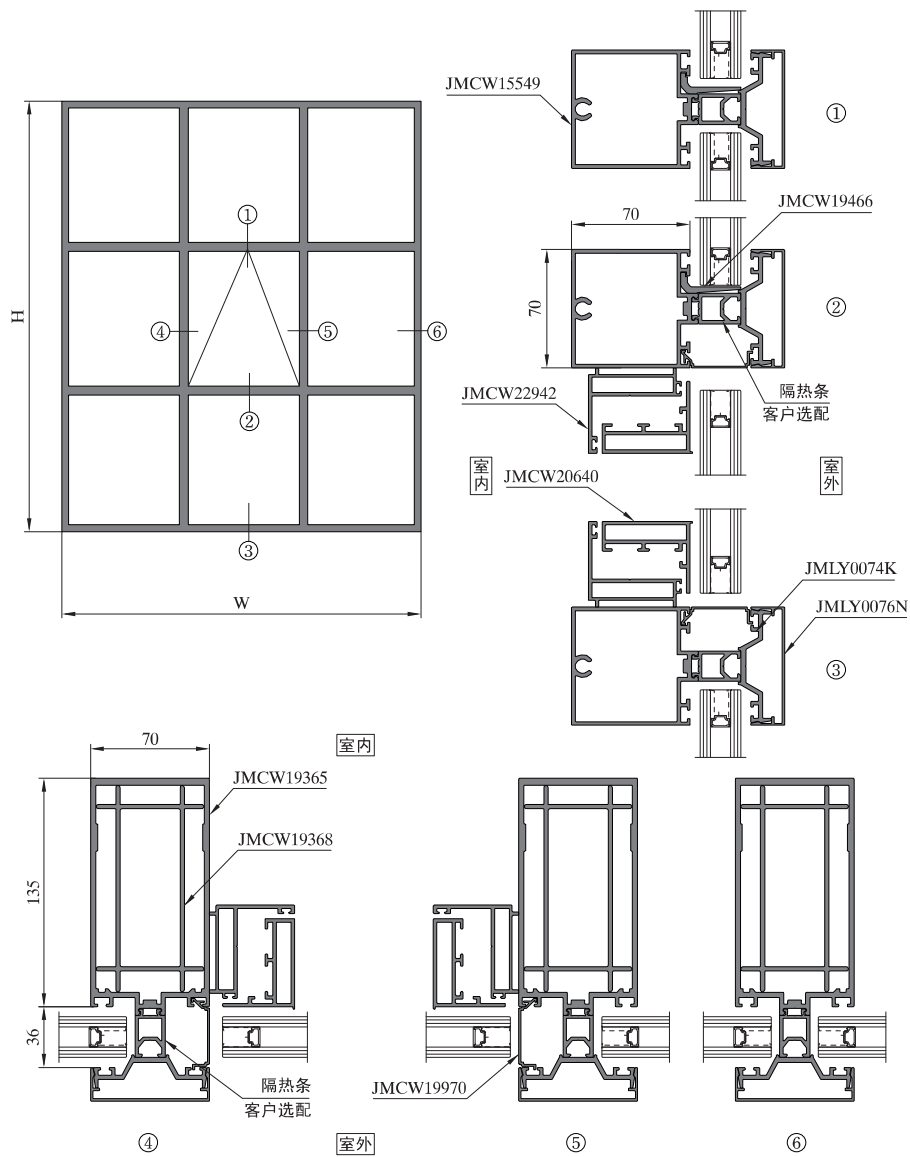

序号 S/N	型号理论重量 JMA Code & KG/M	型材图 Drawing	序号 S/N	型号理论重量 JMA Code & KG/M	型材图 Drawing	序号 S/N	型号理论重量 JMA Code & KG/M	型材图 Drawing
1	主梁 JMCW19959 4.323kg/m	套芯配JMCW19963 	10	主梁 JMLY0070AA JMLY0015B 3.518kg/m	JMLY0070AA JMLY0015B 	19	横梁 JMCW19289 2.196kg/m	
2	主梁 JMCW19285 3.340kg/m	套芯配JMCW19286 	11	主梁 JMLY0070AB JMLY0015B 2.981kg/m	JMLY0070AB JMLY0015B 	20	横梁 JMCW19490 2.049kg/m	
3	主梁 JMCW19464 3.372kg/m	套芯配JMCW27411 	12	阳转角 JMCW19469 2.834kg/m		21	横梁 JMCW19964 2.145kg/m	
4	主梁 JMCW19365 4.087kg/m	套芯配JMCW19368 	13	阳转角 JMCW19489 2.547kg/m		22	横梁 JMLY0075G JMLY0015B 2.731kg/m	JMLY0075G JMLY0015B
5	主梁 JMCW19370 2.820kg/m	套芯配JMCW19457 	14	阴转角 JMCW19468 4.474kg/m		23	横梁 JMCW19371 1.819kg/m	
6	主梁 JMCW19287 2.825kg/m	套芯配JMCW19288 	15	横梁 JMCW19467 3.778kg/m		24	横梁 JMLY0075H JMLY0015B 2.257kg/m	JMLY0075H JMLY0015B
7	主梁 JMCW35101 2.959kg/m	套芯配MQ80438 	16	横梁 JMCW15549 2.235kg/m		25	底板 JMCW19021 1.894kg/m	
8	主梁 JMCW35102 3.410kg/m	套芯配JMCW35103 	17	横梁 JMCW38277 2.453kg/m		26	装饰盖 JMCW19022 2.780kg/m	
9	主梁 JMCW19487 3.402kg/m	套芯配JMCW19488 	18	横梁 JMCW19367 2.478kg/m		27	套芯 JMCW19368 2.633kg/m	主梁配JMCW19365

序号 S/N	型号理论重量 JMA Code & KG/M	型材图 Drawing	序号 S/N	型号理论重量 JMA Code & KG/M	型材图 Drawing	序号 S/N	型号理论重量 JMA Code & KG/M	型材图 Drawing
28	套芯 JMCW27411 3.173kg/m	主梁配JMCW19464 	37	开启框 JMCW22942 0.958kg/m	角码C-5036 	46	玻璃框 JMCW13607 0.424kg/m	配JMCW13615
29	套芯 JMCW19457 2.296kg/m	主梁配JMCW19370 	38	开启框 JMCW24275 1.401kg/m	角码C-5036 	47	托片 JMCW19455 0.165kg/m	配JMCW19366
30	套芯 JMCW19488 2.247kg/m	主梁配JMCW19487 	39	开启框 JMCW20639 1.436kg/m	角码C-5036 	48	玻璃框 JMCW19366 0.323kg/m	
31	套芯 JMCW19288 2.448kg/m	主梁配JMCW19287 	40	开启框 JMCW20642 1.393kg/m	角码C-5036 	49	玻璃框 JMCW17297 0.624kg/m	
32	套芯 JMCW19286 2.719kg/m	主梁配JMCW19285 	41	开启扇 JMCW20640 1.052kg/m	角码C-5036 	50	玻璃框 JMCW15567 0.828kg/m	
33	套芯 JMCW23727 3.021kg/m	主梁配JMCW23726 	42	托片 JMCW24128 0.583kg/m		51	压块 JMCW15563 0.258kg/m	
34	套芯 JMCW19963 3.606kg/m	主梁配JMCW19959 	43	横梁托片 JMCW19466 0.376kg/m		52	压块 JMCW19495 0.823kg/m	
35	套芯 MQ80438 2.850kg/m		44	托片 JMCW19960 0.114kg/m		53	压块 JMCW15564 0.291kg/m	
36	套芯 JMCW35103 2.201kg/m		45	托片 JMCW13615 0.178kg/m	配JMCW13607 	54	辅料 JMCW19970 0.217kg/m	

图中所示型材截面、装配、编号、尺寸及重量仅供参考。如有疑问，请向本公司查询。
Information above just for your reference. Please contact us if you have any questions, Thank you!

图中所示型材截面、装配、编号、尺寸及重量仅供参考。如有疑问，请向本公司查询。
Information above just for your reference. Please contact us if you have any questions, Thank you!

序号 S/N	型号理论重量 JMA Code & KG/M	型材图 Drawing	序号 S/N	型号理论重量 JMA Code & KG/M	型材图 Drawing	序号 S/N	型号理论重量 JMA Code & KG/M	型材图 Drawing
55	连接件 JMCW19465 0.658kg/m		64			73		
56	连接件 JMCW15568 0.662kg/m		65			74		
57	底板 JMLY0074K 0.813kg/m	配JMLY0076N JMLY0077A 	66			75		
58	装饰盖 JMLY0076N 0.489kg/m	配JMLY0074K 	67			76		
59	装饰盖 JMLY0077A 0.423kg/m	配JMLY0074K 	68			77		
60	JMCW19971 0.885kg/m		69			78		
61			70			79		
62			71			80		
63			72			81		

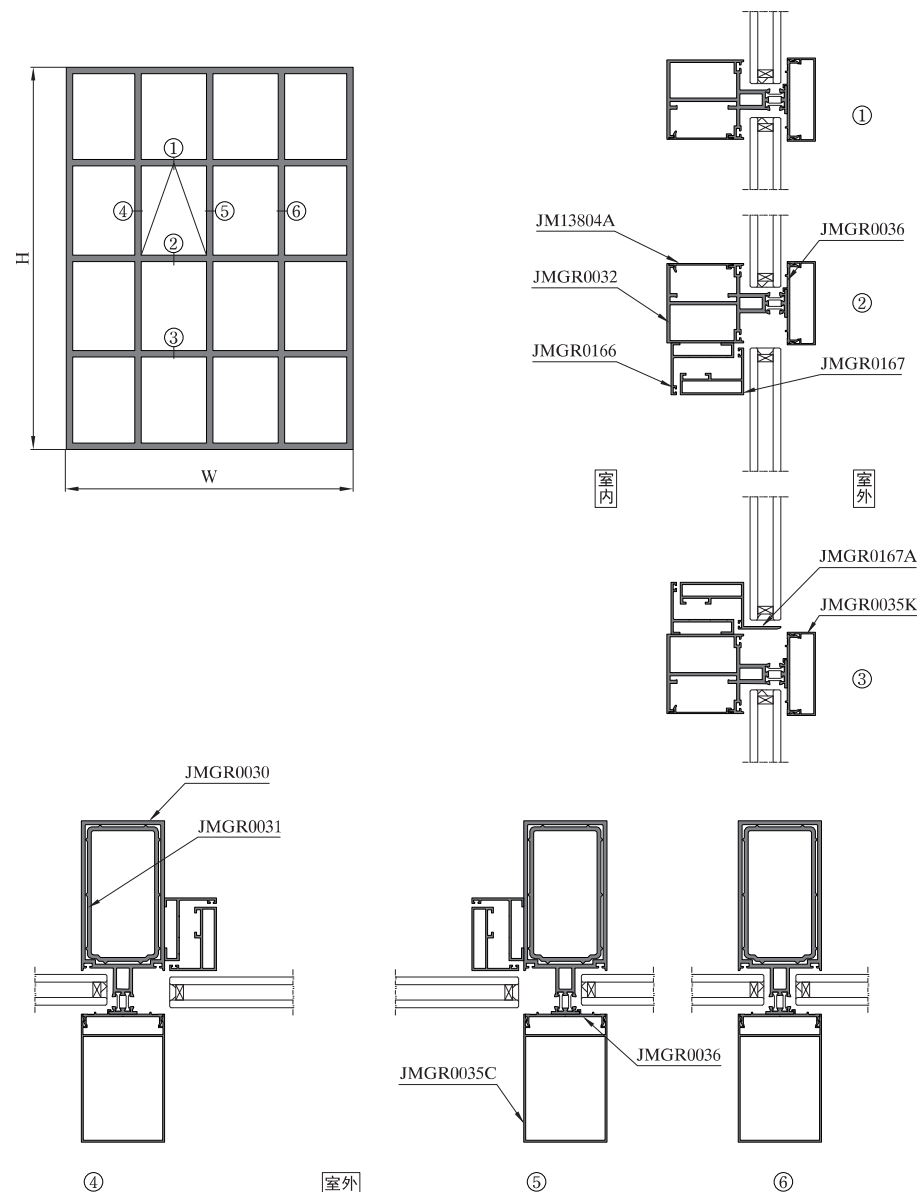

图中所示型材截面、装配、编号、尺寸及重量仅供参考。如有疑问，请向本公司查询。
Information above just for your reference. Please contact us if you have any questions, Thank you!

图中所示型材截面、装配、编号、尺寸及重量仅供参考。如有疑问，请向本公司查询。
Information above just for your reference. Please contact us if you have any questions, Thank you!

序号 S/N	型号理论重量 JMA Code & KG/M	型材图 Drawing	序号 S/N	型号理论重量 JMA Code & KG/M	型材图 Drawing	序号 S/N	型号理论重量 JMA Code & KG/M	型材图 Drawing
1	主梁 JMGR0030 JMGR0034 3.849kg/m		10	横梁盖板 JM13804A 0.215kg/m		19	JMGR0038 2.520kg/m	
2	套芯 JMGR0031 2.739kg/m		11	横梁盖板 JMGR26836 0.235kg/m		20	底板 JMGR0037 0.765kg/m	
3	主梁 JMGR20228 JMGR20252 4.534kg/m		12	横梁盖板 MQ17066 0.212kg/m		21	开启框 LBM12094 0.752kg/m	
4	主梁 JMGR2096 JMGR26832 3.753kg/m		13	JMGR0033 JMGR0034 1.294kg/m		22	开启扇 LBM12095 0.948kg/m	
5	套芯 JMGR20253 3.030kg/m		14	底板 JMGR0036 0.441kg/m		23	开启框 JMGR0166 0.599kg/m	
6	套芯 JMGR26833 3.384kg/m		15	盖板 JMGR0035 0.350kg/m		24	开启扇 JMGR0167 0.761kg/m	
7	横梁 JMGR0032 JMGR0034 2.551kg/m		16	盖板 JMGR0035K 0.406kg/m		25	开启扇 JMGR0167A 0.927kg/m	
8	横梁 JMGR2096 JMGR26835 2.597kg/m		17	盖板 JMGR0035A 1.183kg/m		26	角码 GRO5509 2.690kg/m	
9	横梁 JMGR2096 JMGR2100 2.975kg/m		18	盖板 JMGR0035C 1.425kg/m		27	角码 JM3824 1.331kg/m	

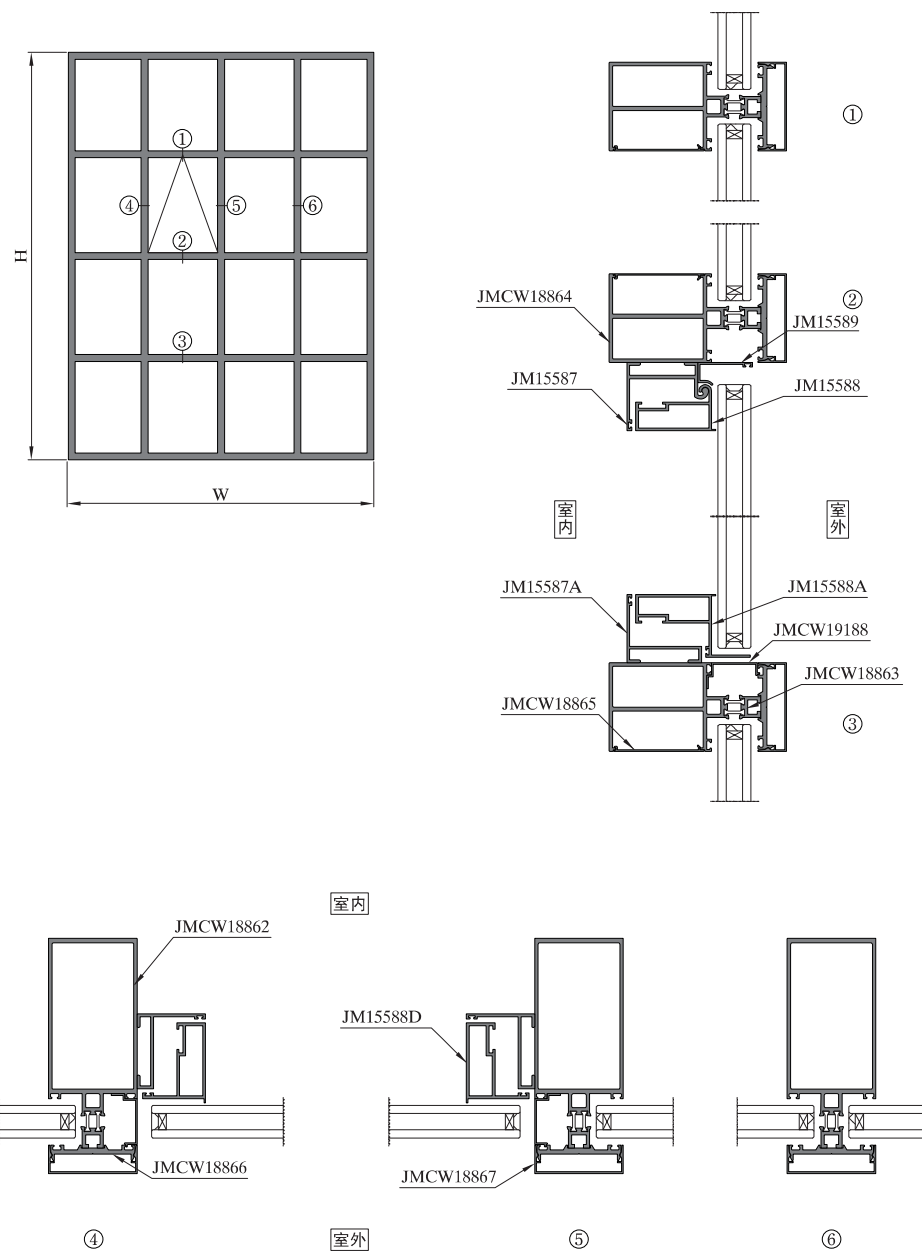

图中所示型材截面、装配、编号、尺寸及重量仅供参考。如有疑问，请向本公司查询。
Information above just for your reference. Please contact us if you have any questions, Thank you!

图中所示型材截面、装配、编号、尺寸及重量仅供参考。如有疑问，请向本公司查询。
Information above just for your reference. Please contact us if you have any questions, Thank you!

序号 S/N	型号理论重量 JMA Code & KG/M	型材图 Drawing	序号 S/N	型号理论重量 JMA Code & KG/M	型材图 Drawing	序号 S/N	型号理论重量 JMA Code & KG/M	型材图 Drawing
1	JMCW18862 JMCW18863 3.743kg/m		10	JM15589 0.288kg/m		19		
2	JMCW20442 3.144kg/m		11	JMCW19188 0.227kg/m		20		
3	JMCW18863 JMCW18864 2.895kg/m		12	JMCW18866 0.779kg/m		21		
4	JMCW18865 0.237kg/m		13	JMCW18867 0.408kg/m		22		
5	JM15587 1.023kg/m		14	JMCW18871 1.029kg/m		23		
6	JM15587A 0.760kg/m		15	JM5004A 2.354kg/m		24		
7	JM15588 1.025kg/m		16			25		
8	JM15588A 1.213kg/m		17			26		
9	JM15588D 1.080kg/m		18			27		

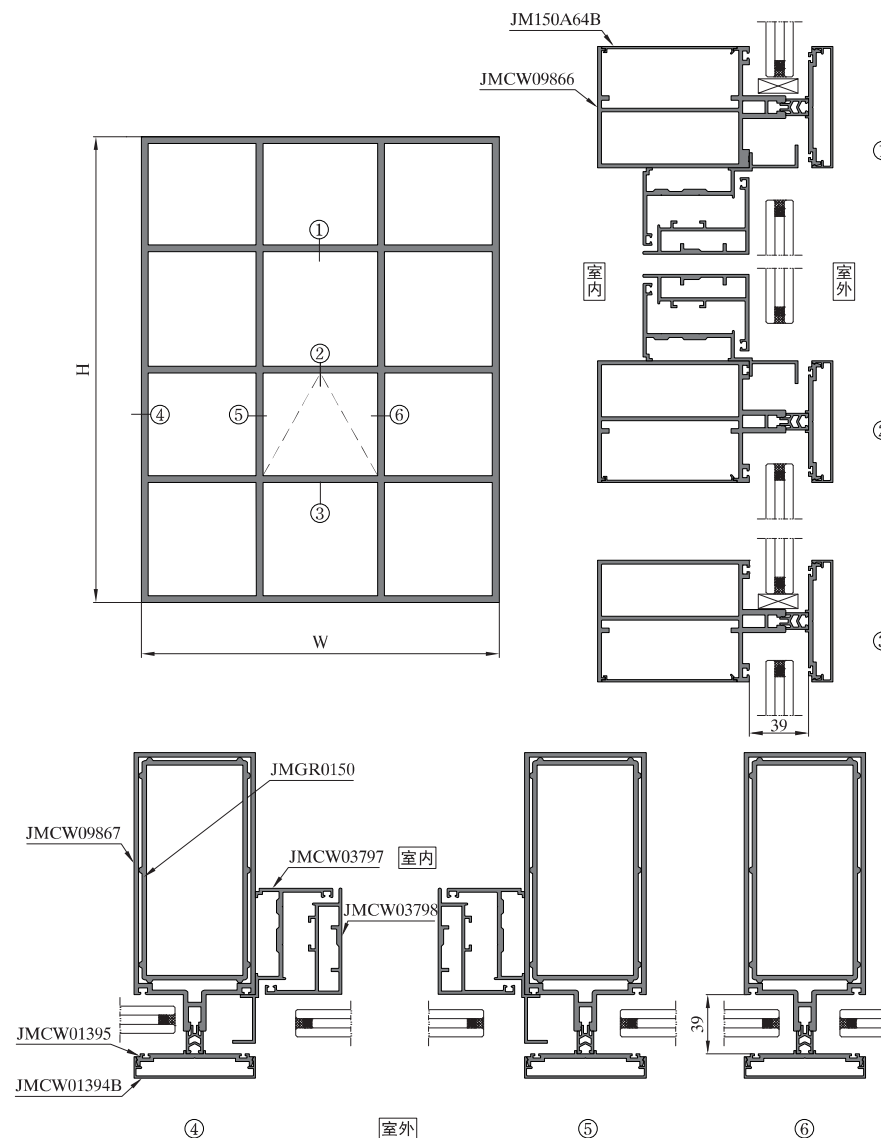

序号 S/N	型号理论重量 JMA Code & KG/M	型材图 Drawing	序号 S/N	型号理论重量 JMA Code & KG/M	型材图 Drawing	序号 S/N	型号理论重量 JMA Code & KG/M	型材图 Drawing
1	JMCW09867 4.702kg/m	套芯配JMGR0150 塑胶条 	10	JM14054B 0.295kg/m		19		
2	JMCW14963 4.042kg/m	套芯配JMCW14964 	11	JMCW03796 1.469kg/m		20		
3	JMCW14965 2.878kg/m	套芯配JMCW14966 	12	JMCW03797 1.379kg/m		21		
4	JMGR0150 3.829kg/m		13	JMCW03798 1.355kg/m	角码配GRF8009 	22		
5	JMCW14964 4.140kg/m		14	JMCW01394A 2.171kg/m		23		
6	JMCW14966 2.625kg/m		15	JMCW01394B 0.472kg/m		24		
7	JMCW09866 3.452kg/m	盖板配JM150A64B 	16	JMCW01395 0.762kg/m	盖板配JMCW01394B 	25		
8	JM14053A 2.303kg/m	盖板配JM14054B 	17	GRF8009 3.525kg/m		26		
9	JM150A64B 0.386kg/m		18			27		

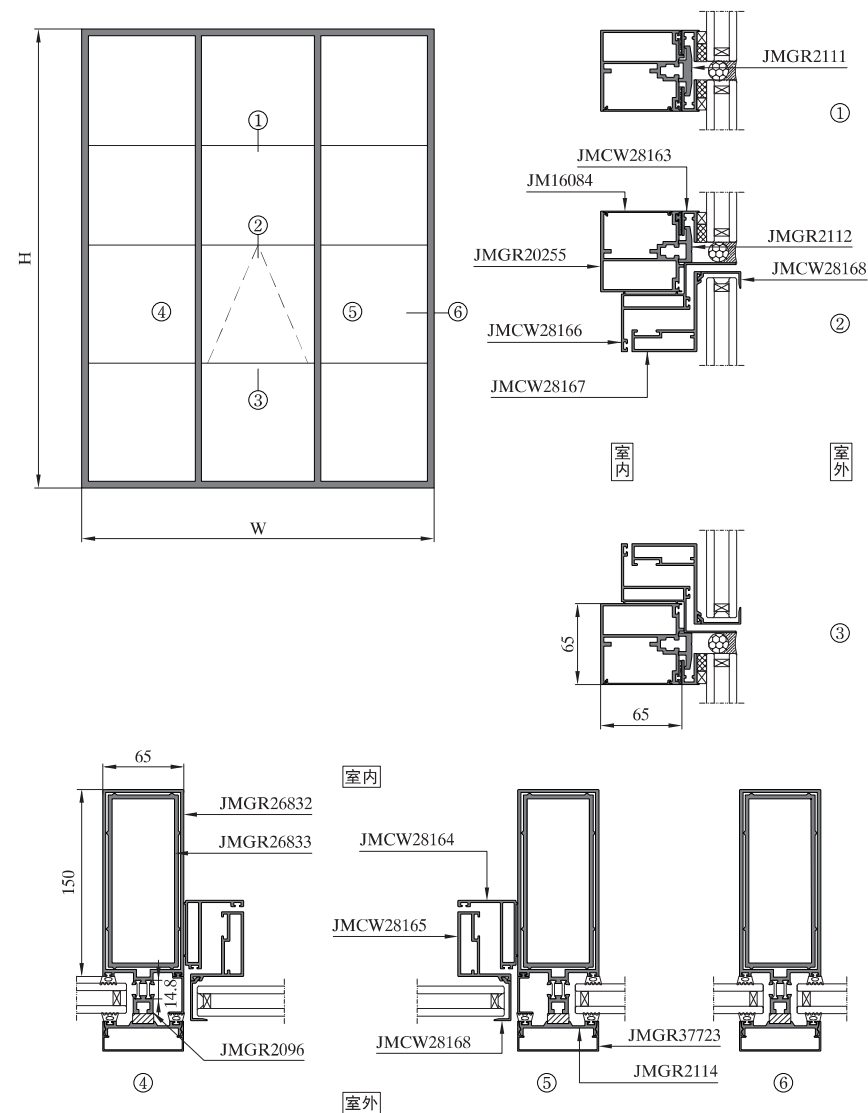

图中所示型材截面、装配、编号、尺寸及重量仅供参考。如有疑问，请向本公司查询。
Information above just for your reference. Please contact us if you have any questions, Thank you!

图中所示型材截面、装配、编号、尺寸及重量仅供参考。如有疑问，请向本公司查询。
Information above just for your reference. Please contact us if you have any questions, Thank you!

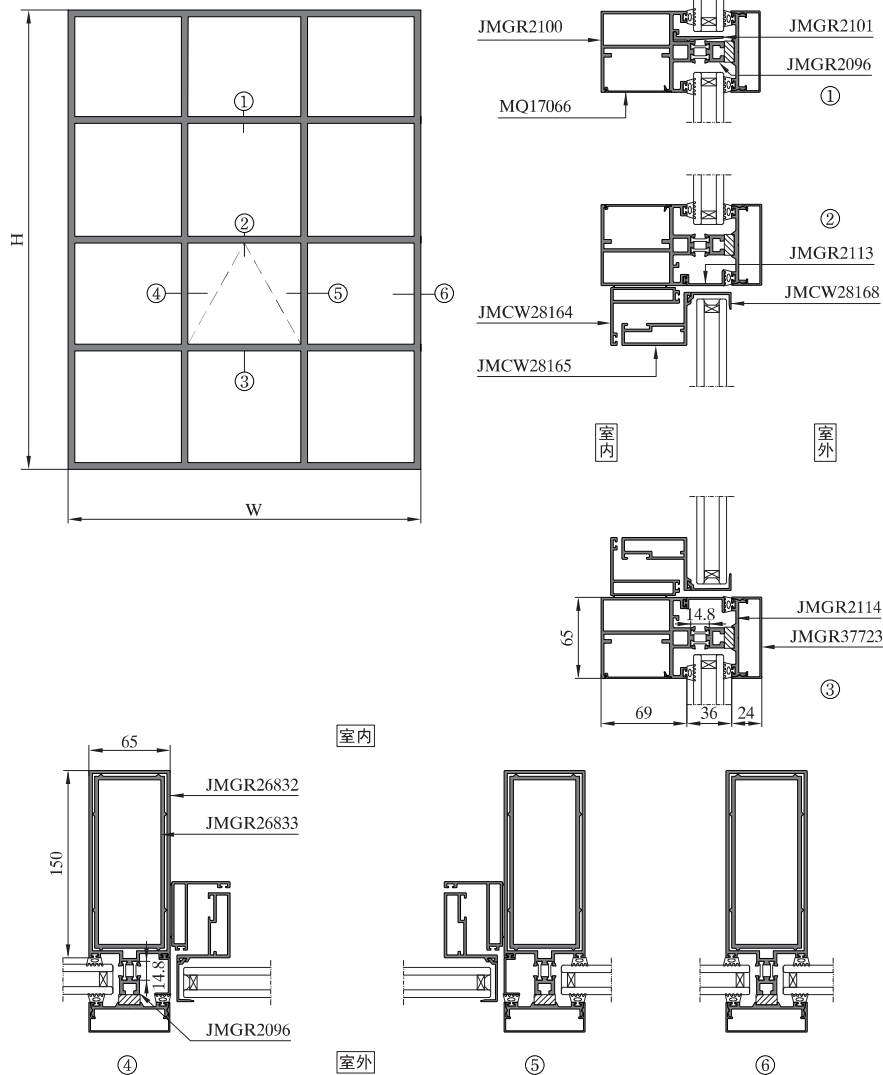

序号 S/N	型号理论重量 JMA Code & KG/M	型材图 Drawing	序号 S/N	型号理论重量 JMA Code & KG/M	型材图 Drawing	序号 S/N	型号理论重量 JMA Code & KG/M	型材图 Drawing
1	主梁 JMGR2095 JMGR2096 3.915kg/m	套芯JMGR2097 JMGR2096	10	主梁 JMCW15403 3.647kg/m	套芯JMCW06096	19	套芯 JMGR2097 2.874kg/m	主梁JMGR2095
2	主梁 JMGR2096 JMGR22624 4.208kg/m	JMGR22624 套芯JMGR22625 JMGR2096	11	主梁 JMGR23683 3.256kg/m		20	套芯 JMGR22625 3.225kg/m	主梁JMGR22624
3	主梁 JMGR2096 JMGR26832 3.753kg/m	套芯JMGR26833 JMGR2096	12	边梁 JMGR20465 2.463kg/m		21	套芯 JMGR26833 3.384kg/m	主梁JMGR26832 JMGR26845
4	主梁 JMGR2096 JMGR20109 4.353kg/m	JMGR20109 JMGR2096	13	横梁 JMCW09446 2.881kg/m	横梁盖板JMCW09447	22	套芯 JMGR37761 4.109kg/m	
5	主梁 JMGR2096 JMGR37760 4.939kg/m	套芯JMGR37761 JMGR37760 JMGR2096	14	横梁 JMGR26837 1.835kg/m	横梁盖板JMGR26838	23	横梁盖板 JMUW20044 0.176kg/m	配JMUW20043
6	横梁 JMGR2096 JMUW20043 2.851kg/m	横梁盖板JMUW20044	15	横梁 JMCW15404 2.148kg/m	横梁盖板MQ14004E	24	横梁盖板 JMGR26836 0.235kg/m	配JMGR26835
7	横梁 JMGR2096 JMGR26835 2.597kg/m	横梁盖板JMGR26836	16	横梁 JMGR21089 2.019kg/m	横梁盖板JMGR21090	25	横梁盖板 MQ17066 0.212kg/m	配JMGR2100
8	横梁 JMGR2096 JMGR2100 2.975kg/m	JMGR2100 横梁盖板MQ17066 JMGR2096	17	横梁 JMGR20255 2.038kg/m	横梁盖板JM16084	26	横梁盖板 JMCW09447 0.241kg/m	配JMCW09446
9	主梁 JMCW10649 2.913kg/m		18	主梁A JMGR2096 JMGR37742 1.616kg/m	JMGR2096 JMGR37742	27	横梁盖板 JMGR23734 0.266kg/m	配JMGR23733

图中所示型材截面、装配、编号、尺寸及重量仅供参考。如有疑问，请向本公司查询。
Information above just for your reference. Please contact us if you have any questions, Thank you!

图中所示型材截面、装配、编号、尺寸及重量仅供参考。如有疑问，请向本公司查询。
Information above just for your reference. Please contact us if you have any questions, Thank you!

序号 S/N	型号理论重量 JMA Code & KG/M	型材图 Drawing	序号 S/N	型号理论重量 JMA Code & KG/M	型材图 Drawing	序号 S/N	型号理论重量 JMA Code & KG/M	型材图 Drawing
28	横梁盖板 JMGR26838 0.200kg/m		37	底板 JMGR2114 0.650kg/m		46	玻璃框 JMCW10900 0.409kg/m	
29	横梁盖板 MQ14004E 0.166kg/m	配JMCW15404 	38	底板 JMGR23958 0.726kg/m		47	玻璃框 JMCW15296 0.498kg/m	
30	横梁盖板 JMGR21090 0.195kg/m	配JMGR21089 	39	装饰盖 JMGR37723 0.434kg/m	配JMGR2114 JMGR23958 	48	玻璃框 JMCW12339 0.381kg/m	
31	横梁盖板 JM16084 0.199kg/m	配JMGR20255 	40	装饰盖 JMGR2115 0.575kg/m	配JMGR2114 JMGR23958 	49	玻璃框 JMUW22147 0.424kg/m	
32	开启框 JMCW28164 0.934kg/m	角码C-5036 	41	装饰盖 JMGR23957 0.727kg/m	配JMGR2114 JMGR23958 	50	玻璃框 JMGR20983 0.436kg/m	
33	开启框 JMCW28166 1.219kg/m	角码C-5036 	42	装饰盖 JMGR23959 2.540kg/m		51	玻璃框 JMGR2435 0.422kg/m	
34	开启扇 JMCW28165 1.036kg/m	角码C-5036 	43	压块 JMGR2111 0.676kg/m		52	玻璃框 JMGR2436 0.438kg/m	
35	开启扇 JMCW28167 1.164kg/m	角码C-5036 	44	压块 JMGR2112 0.451kg/m		53	托块 JMGR37728 0.731kg/m	
36	封边 JMCW28168 0.235kg/m	配JMCW28165 JMCW28167 	45	玻璃框 JMCW28163 0.330kg/m		54	托块 JMGR2101 0.323kg/m	

序号 S/N	型号理论重量 JMA Code & KG/M	型材图 Drawing	序号 S/N	型号理论重量 JMA Code & KG/M	型材图 Drawing	序号 S/N	型号理论重量 JMA Code & KG/M	型材图 Drawing
55	封边 JMGR2113 0.240kg/m		64			73		
56	封边 JMGR37746 0.367kg/m		65			74		
57			66			75		
58			67			76		
59			68			77		
60			69			78		
61			70			79		
62			71			80		
63			72			81		

图中所示型材截面、装配、编号、尺寸及重量仅供参考。如有疑问，请向本公司查询。
 Information above just for your reference. Please contact us if you have any questions, Thank you!

图中所示型材截面、装配、编号、尺寸及重量仅供参考。如有疑问，请向本公司查询。
 Information above just for your reference. Please contact us if you have any questions, Thank you!

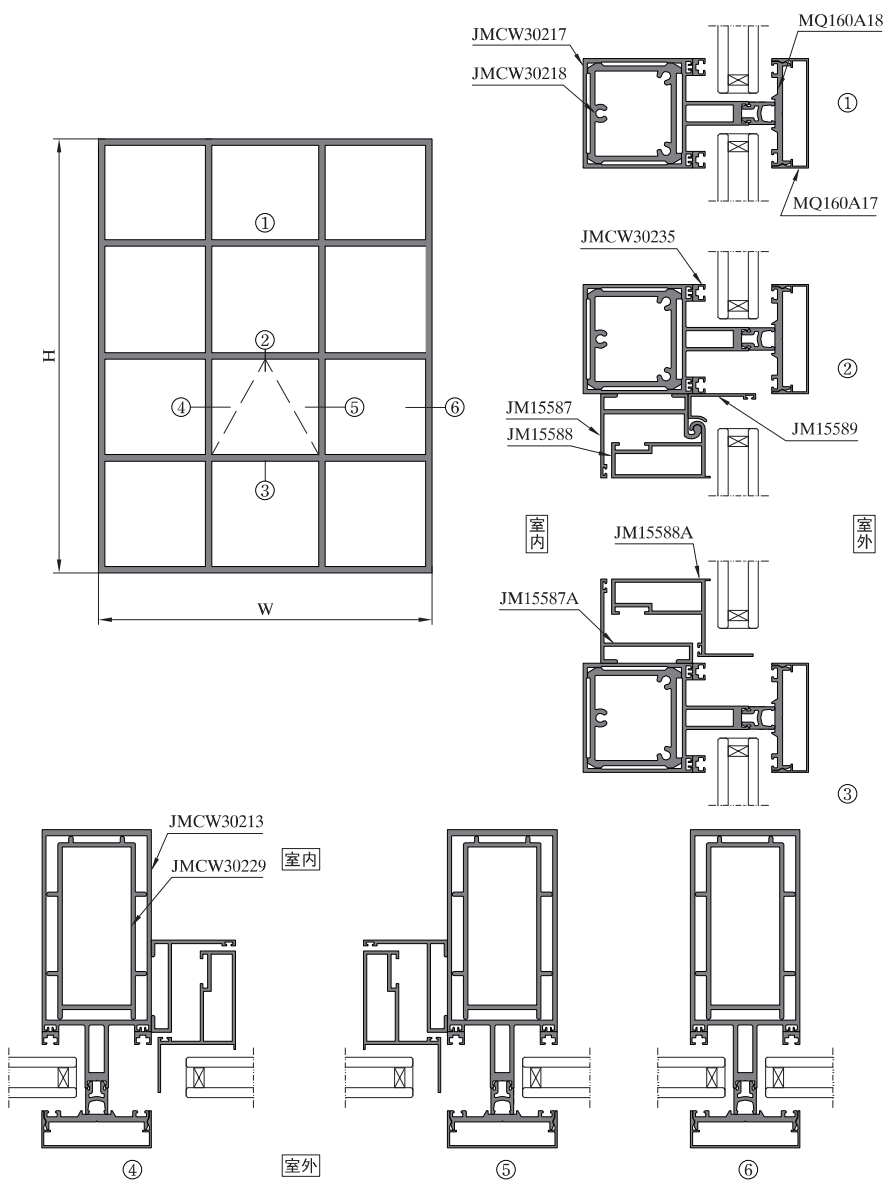

序号 S/N	型号理论重量 JMA Code & KG/M	型材图 Drawing	序号 S/N	型号理论重量 JMA Code & KG/M	型材图 Drawing	序号 S/N	型号理论重量 JMA Code & KG/M	型材图 Drawing
1	主梁 JMCW30212 3.675kg/m	套芯JMCW30229 65, 3.5, 2.5, 120, 39.5, 159.5	10	套芯 JMCW30260 2.097kg/m	59.6, 45.6	19	封边 JM15589 0.288kg/m	16.7, 40
2	主梁 JMCW30213 3.588kg/m	套芯JMCW30229 65, 3.5, 2.5, 120, 33.5, 153.5	11	套芯 JMCW30218 2.258kg/m	59.6, 55.6	20	底板 MQ160A18 0.775kg/m	11.3, 17, 4, 62
3	主梁 JMCW30215 4.115kg/m	套芯JMCW30230 65, 3.5, 2.5, 150, 39.5, 189.5	12	底板 JMCW30231 1.592kg/m	112.8, 47.4	21	装饰盖 MQ160A17 0.419kg/m	22, 1.2, 65
4	转角 JMCW30228 4.238kg/m	套芯JMCW30229 65, 3.5, 2.5, 134.7, 196.8	13	装饰盖 JMCW30232 1.520kg/m	101, 101, 1.2	22	装饰盖 MQ160A17F 0.602kg/m	48, 1.2, 65
5	横梁 JMCW30216 2.255kg/m	套芯JMCW30218 65, 2, 2, 65, 39.5, 104.5	14	开启框 JM15587 1.023kg/m	50, 2, 59.8	23	装饰盖 MQ160A17G 0.531kg/m	38, 1.2, 65
6	横梁 JMCW30217 2.185kg/m	套芯JMCW30218 65, 2, 2, 65, 33.5, 98.5	15	开启框 JM15587A 0.760kg/m	50, 2, 54.7	24		
7	横梁 JMCW30259 1.635kg/m	65, 2, 55	16	开启扇 JM15588 1.025kg/m	角码JM5004A 33.8, 2, 58.5	25		
8	套芯 JMCW30229 2.378kg/m	59.5, 2.5, 109	17	开启扇 JM15588D 1.080kg/m	角码JM5004A 46, 2, 58.5	26		
9	套芯 JMCW30230 2.817kg/m	59.5, 2.5, 139	18	开启扇 JM15588A 1.213kg/m	角码JM5004A 84, 46	27		

图中所示型材截面、装配、编号、尺寸及重量仅供参考。如有疑问，请向本公司查询。
Information above just for your reference. Please contact us if you have any questions, Thank you!

图中所示型材截面、装配、编号、尺寸及重量仅供参考。如有疑问，请向本公司查询。
Information above just for your reference. Please contact us if you have any questions, Thank you!

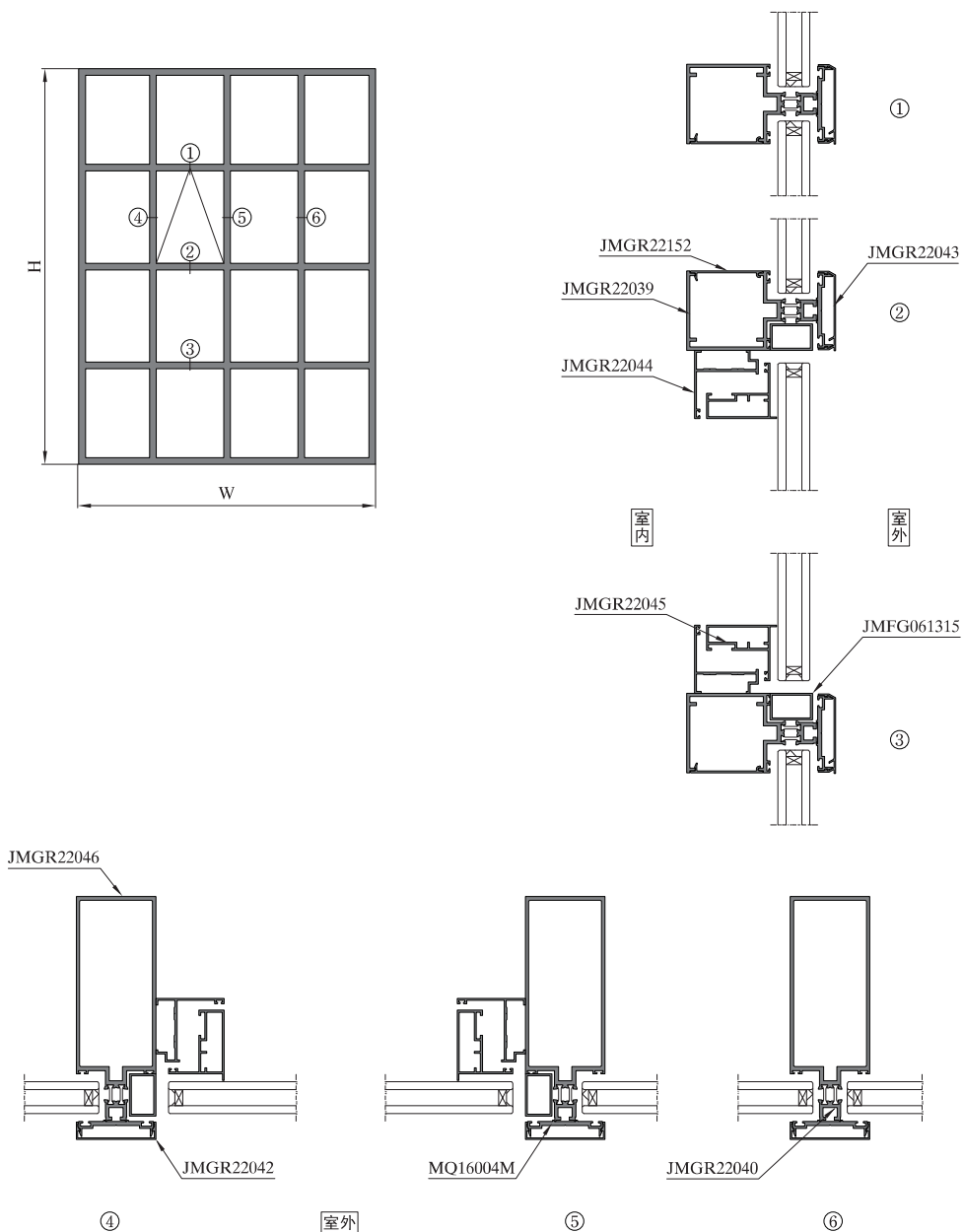

序号 S/N	型号理论重量 JMA Code & KG/M	型材图 Drawing	序号 S/N	型号理论重量 JMA Code & KG/M	型材图 Drawing	序号 S/N	型号理论重量 JMA Code & KG/M	型材图 Drawing
1	主梁 JMGR22040 JMGR22046 3.685kg/m		10	GR50A18 2.649kg/m		19		
2	横梁 JMGR22039 JMGR22040 2.178kg/m		11			20		
3	开启框 JMGR22044 0.602kg/m		12			21		
4	开启扇 JMGR22045 0.779kg/m	角码配GR50A18 	13			22		
5	横梁盖板 JMGR22152 0.275kg/m		14			23		
6	底板 MQ16004M 0.542kg/m		15			24		
7	装饰盖 JMGR22042 0.293kg/m		16			25		
8	装饰盖 JMGR22043 0.315kg/m		17			26		
9	JMFG061315 0.430kg/m		18			27		

图中所示型材截面、装配、编号、尺寸及重量仅供参考。如有疑问，请向本公司查询。
Information above just for your reference. Please contact us if you have any questions, Thank you!

图中所示型材截面、装配、编号、尺寸及重量仅供参考。如有疑问，请向本公司查询。
Information above just for your reference. Please contact us if you have any questions, Thank you!

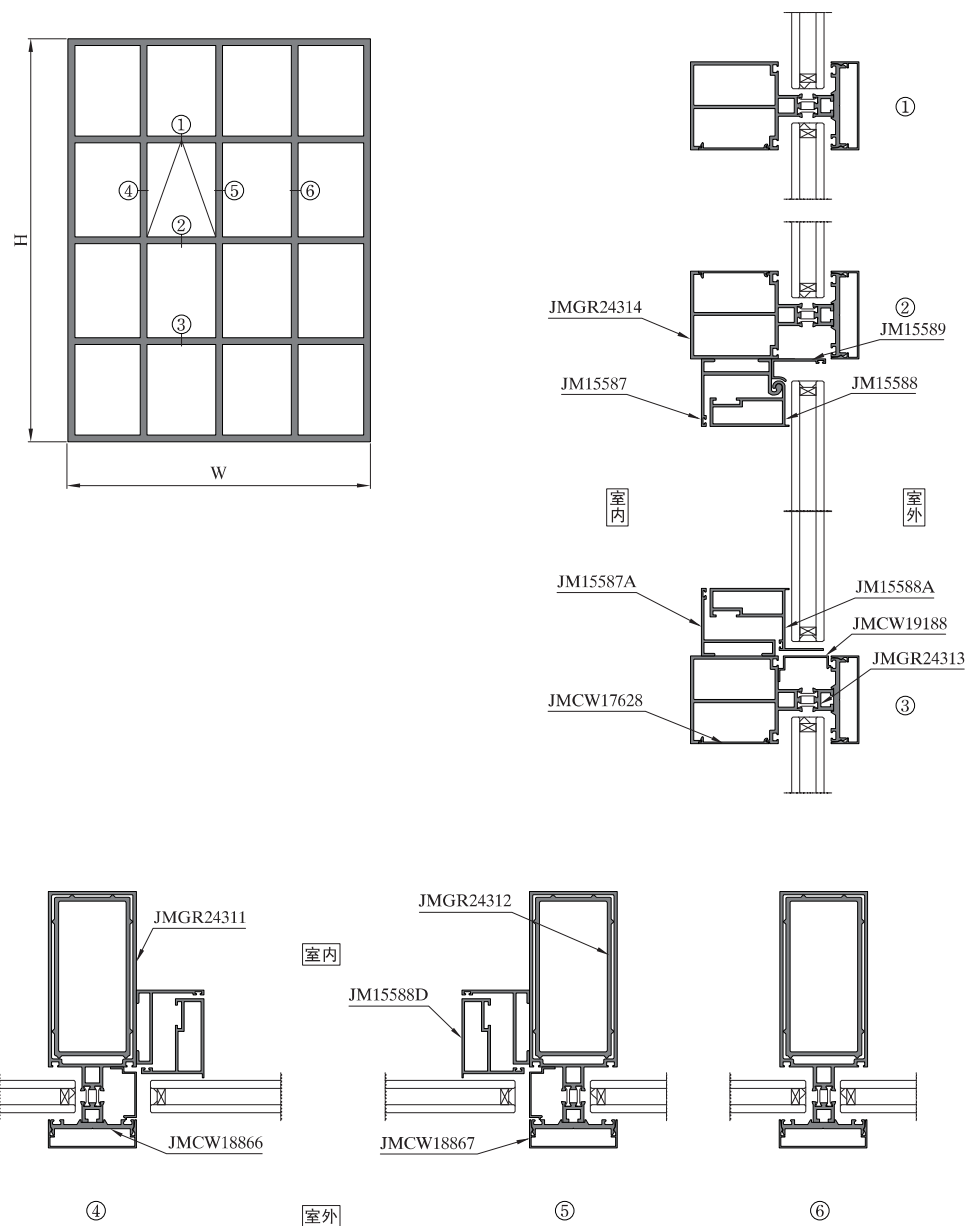

序号 S/N	型号理论重量 JMA Code & KG/M	型材图 Drawing	序号 S/N	型号理论重量 JMA Code & KG/M	型材图 Drawing	序号 S/N	型号理论重量 JMA Code & KG/M	型材图 Drawing
1	JMGR24311 JMGR24313 3.455kg/m		10	JM15589 0.288kg/m		19		
2	JMGR24312 3.034kg/m		11	JMCW19188 0.227kg/m		20		
3	JMGR24314 JMGR24313 2.640kg/m		12	JMCW18866 0.779kg/m		21		
4	JMCW17628 0.212kg/m		13	JMCW18867 0.408kg/m		22		
5	JM15587 1.023kg/m		14	JM5004A 2.354kg/m		23		
6	JM15587A 0.760kg/m		15			24		
7	JM15588 1.025kg/m		16			25		
8	JM15588A 1.213kg/m		17			26		
9	JM15588D 1.080kg/m		18			27		

图中所示型材截面、装配、编号、尺寸及重量仅供参考。如有疑问，请向本公司查询。
Information above just for your reference. Please contact us if you have any questions, Thank you!

图中所示型材截面、装配、编号、尺寸及重量仅供参考。如有疑问，请向本公司查询。
Information above just for your reference. Please contact us if you have any questions, Thank you!

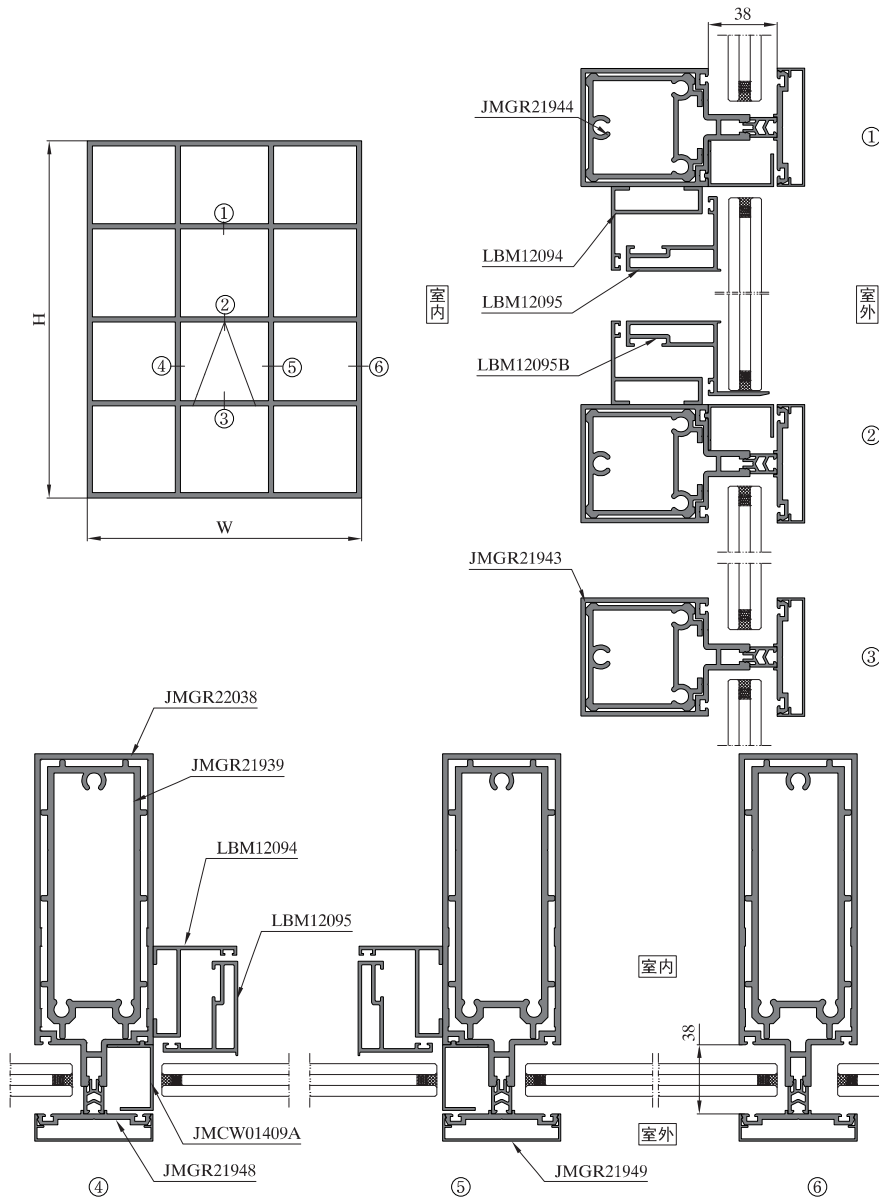

序号 S/N	型号理论重量 JMA Code & KG/M	型材图 Drawing	序号 S/N	型号理论重量 JMA Code & KG/M	型材图 Drawing	序号 S/N	型号理论重量 JMA Code & KG/M	型材图 Drawing
1	JMGR21938 4.261kg/m	套芯配JMGR21939 160 65 3	10	JMGR21944 2.211kg/m	63.95 59.5 2.5	19		
2	JMGR22038 4.452kg/m	套芯配JMGR21939 65 3 160 183 23 4.2	11	LBM12094 0.752kg/m	2 46 50	20		
3	MQ80556 4.594kg/m	套芯配MQ80557 65 3 170 187.2 17.2 1.6	12	LBM12094A 0.868kg/m	2 55 72	21		
4	MQ80556A 3.852kg/m	套芯配JM12010A 65 3 126 143.2 17.2 1.6	13	LBM12095 0.948kg/m	角码配GRQ5509 41 2 10 52	22		
5	JMGR21939 4.566kg/m	153.5 58.5 3.5	14	LBM12095B 1.108kg/m	角码配GRQ5509 78.5 41 2 10	23		
6	MQ80557 3.717kg/m	157.3 58.5 3	15	JMGR21948 0.624kg/m	62.2 11.5 6	24		
7	JM12010A 2.484kg/m	2.5 113.5 58.5	16	JMGR21949 0.355kg/m	1.5 17.2 65	25		
8	JMGR21943 2.448kg/m	套芯配JMGR21944 93 65 2.5 70 23 14.2	17	JMCW01409A 0.348kg/m	38 25 1.5	26		
9	JMGR22036 2.229kg/m	套芯配JMGR21944 70 65 2.5	18	GRQ5509 2.690kg/m	60 60 9.7	27		

图中所示型材截面、装配、编号、尺寸及重量仅供参考。如有疑问，请向本公司查询。
Information above just for your reference. Please contact us if you have any questions, Thank you!

图中所示型材截面、装配、编号、尺寸及重量仅供参考。如有疑问，请向本公司查询。
Information above just for your reference. Please contact us if you have any questions, Thank you!

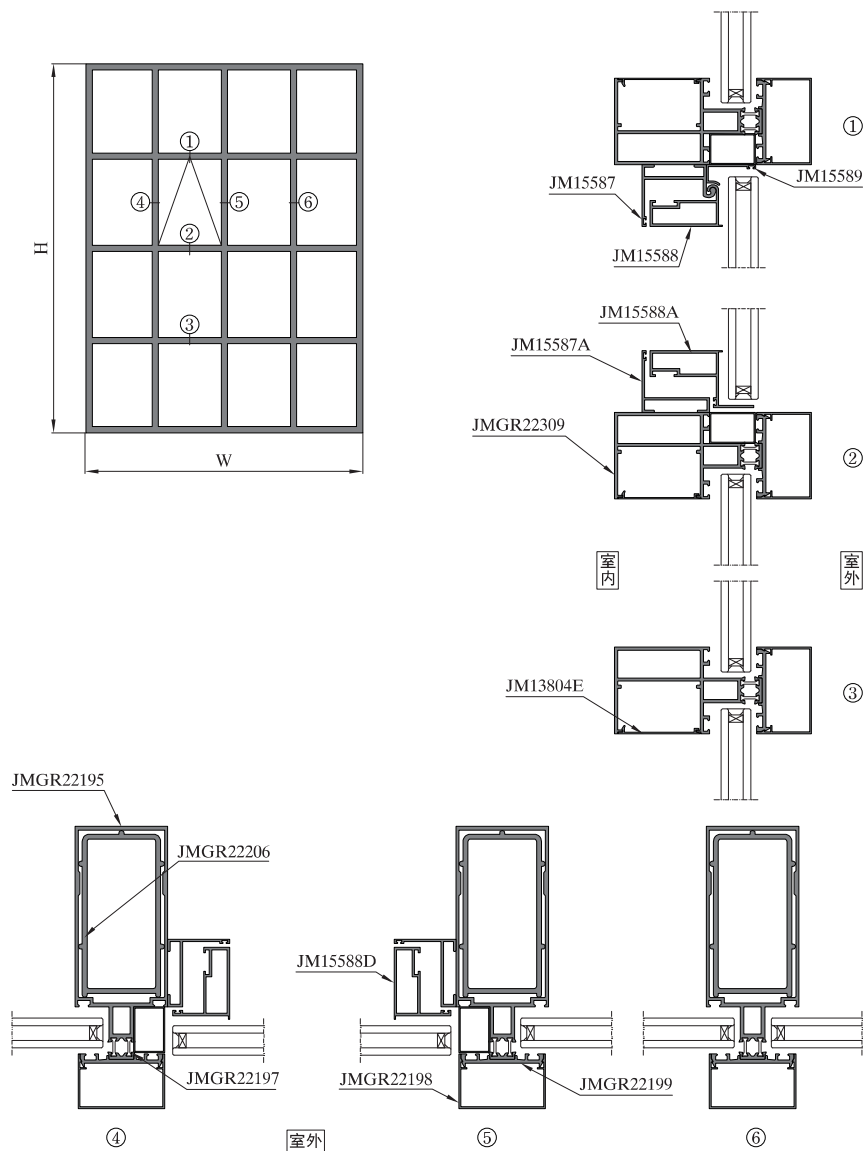

序号 S/N	型号理论重量 JMA Code & KG/M	型材图 Drawing	序号 S/N	型号理论重量 JMA Code & KG/M	型材图 Drawing	序号 S/N	型号理论重量 JMA Code & KG/M	型材图 Drawing
1	JMGR22195 JMGR22197 4.538kg/m	套芯配JMGR22206 146 JMGR22197 75 2.5 14.8 188.5 JMGR22195	10	JM15587A 0.760kg/m	54.7 50 2	19	JMGR22199 0.754kg/m	66.6 10.9 3
2	JMGR22194 JMGR22197 4.560kg/m	套芯配JMGR22206 JMGR22194 75 2.5 13.5 14.8 195.3 JMGR22197	11	JM15587B 1.403kg/m	92 77.75 2.5	20	JMCW01972 0.788kg/m	11.3 72 3
3	JMGR22206 4.495kg/m	69.5 4 135	12	JM15587C 1.284kg/m	91.7 77.5 2	21	JMGR22285 1.504kg/m	103.97 33.38 3.5
4	JMGR22309 JMGR22197 3.182kg/m	77 2.5 14.8 20 119.5 JMGR22197 JMGR22309	13	JM15588 1.025kg/m	角码配JM5004A 2 33.8 12.5 58.5	22	JMGR22198 0.725kg/m	底板配JMGR22199 44.45 1.5 70
5	JMGR22310 1.944kg/m	76.9 70 2	14	JM15588A 1.213kg/m	角码配JM5004A 46 12.5 2 83.95	23	JMGR22311 1.702kg/m	底板配JMGR22199 1.5 70 93.5
6	JM13804E 0.275kg/m	6.7 1.2 67	15	JM15588B 1.212kg/m	角码配JM5004A 2.5 2 61 58.5	24	JMCW01973 0.875kg/m	底板配JMCW01972 45 1.2 75
7	JMGR22200 0.716kg/m	43 2 57.5	16	JM15588C 1.392kg/m	角码配JM5004A 70.5 12.5 2 84.5	25	JMCW01976 0.864kg/m	底板配JMCW01972 45 1.2 75
8	JMGR22201 0.995kg/m	角码配JMGR50B05 42 2 14 57	17	JM15588D 1.08kg/m	角码配JM5004A 12.5 2 46 58.5	26	JMLY0050 0.238kg/m	1.3 14 36.3
9	JM15587 1.023kg/m	52 50 2.5	18	JM15589 0.288kg/m	1.5 40 16.7	27	JM5004A 2.354kg/m	50 50 12.3

图中所示型材截面、装配、编号、尺寸及重量仅供参考。如有疑问，请向本公司查询。
Information above just for your reference. Please contact us if you have any questions, Thank you!

图中所示型材截面、装配、编号、尺寸及重量仅供参考。如有疑问，请向本公司查询。
Information above just for your reference. Please contact us if you have any questions, Thank you!

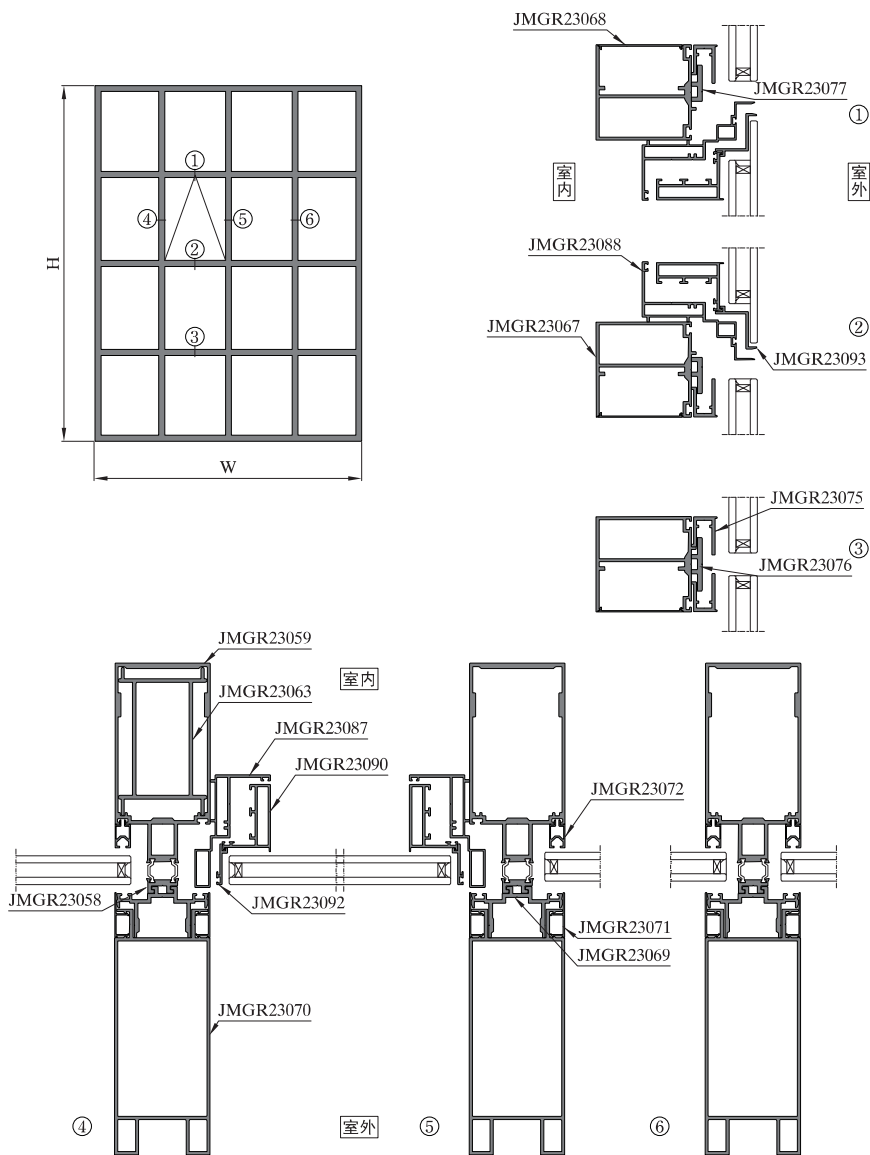

序号 S/N	型号理论重量 JMA Code & KG/M	型材图 Drawing	序号 S/N	型号理论重量 JMA Code & KG/M	型材图 Drawing	序号 S/N	型号理论重量 JMA Code & KG/M	型材图 Drawing
1	JMGR23058 JMGR23059 5.527kg/m	套芯配JMGR23063 193 135 20 80 JMGR23059 JMGR23058	10	JMGR23068 0.267kg/m	71.1 4.1 1.2	19	JMGR23072 0.262kg/m	13 23.55
2	JMGR23058 JMGR23060 5.747kg/m	套芯配JMGR23064 208 150 20 80 2.5 JMGR23060 JMGR23058	11	JMGR23086 1.402kg/m	角码配JM3824 2 82.5 94.5	20	JMGR23074 0.554kg/m	19.8 32 2.5
3	JMGR23061 4.078kg/m	套芯配JMGR23063 135 80 2.5	12	JMGR23087 1.399kg/m	角码配JM3824 2 63.5 94.5	21	JMGR23075 0.571kg/m	21.8 32 2.5
4	JMGR23079 4.403kg/m	185 80 2.5 90° 154.93	13	JMGR23088 1.433kg/m	角码配JM3824 2 82.5 94.5	22	JMGR23076 0.630kg/m	45 4 9
5	JMGR23063 3.306kg/m	69.5 3 124.5	14	JMGR23090 1.065kg/m	角码配JM3824 2 40.5 56.5	23	JMGR23077 0.459kg/m	4 30.5 9
6	JMGR23064 3.570kg/m	74.5 3 139.5	15	JMGR23091 1.240kg/m	角码配JM3824 2 70.5 56.5	24	JMGR23078 0.823kg/m	90° 4 50.34 16.38
7	JMGR23065 3.347kg/m	160 74.5 2.5	16	JMGR23069 1.605kg/m	76.9 43 3	25	JMGR23089 0.657kg/m	50.37 18 3.5
8	JMGR23066 3.980kg/m	74.5 3.2 147	17	JMGR23070 4.995kg/m	80 2.5 206	26	JMGR23092 0.266kg/m	34 9.1 2
9	JMGR23067 2.624kg/m	盖板配JMGR23068 84 2.5 80	18	JMGR23071 0.200kg/m	11.97 1.2 37.8	27	JMGR23093 0.409kg/m	36.1 2 34.6

图中所示型材截面、装配、编号、尺寸及重量仅供参考。如有疑问，请向本公司查询。
Information above just for your reference. Please contact us if you have any questions, Thank you!

图中所示型材截面、装配、编号、尺寸及重量仅供参考。如有疑问，请向本公司查询。
Information above just for your reference. Please contact us if you have any questions, Thank you!

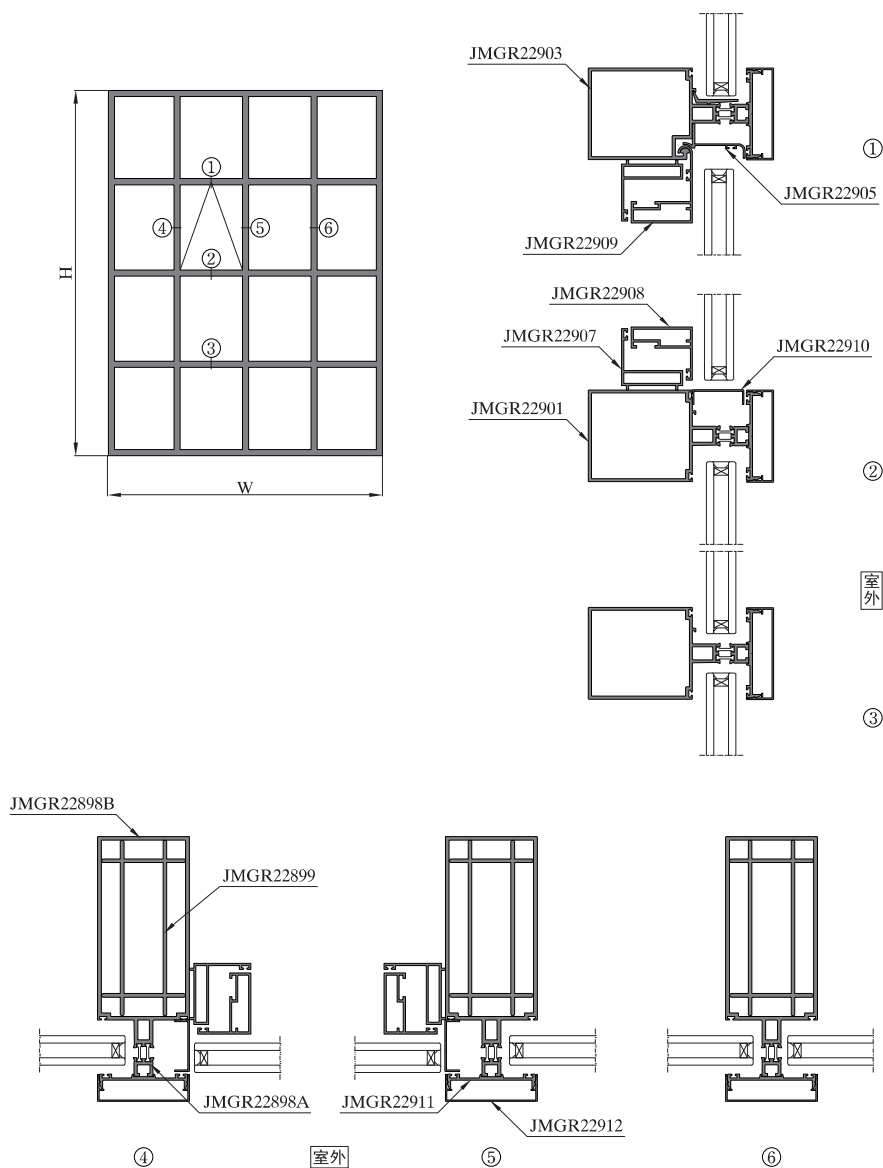

序号 S/N	型号理论重量 JMA Code & KG/M	型材图 Drawing	序号 S/N	型号理论重量 JMA Code & KG/M	型材图 Drawing	序号 S/N	型号理论重量 JMA Code & KG/M	型材图 Drawing
1	JMGR22898A JMGR22898B 4.828kg/m	套芯配JMGR22899 JMGR22898A 150 15.5 14.8 3 75 196 JMGR22898B	10	JMGR22909 1.079kg/m	角码配PC5086 63 1.8 8.7 50	19		
2	JMGR22898A JMGR22900 5.179kg/m	JMGR22898A JMGR22900 170 15.5 14.8 3 75 216	11	JMGR22911 0.666kg/m	72 2 11.7	20		
3	JMGR22899 3.595kg/m	143.5 68.5 3	12	JMGR22912 0.442kg/m	1.2 22 75	21		
4	JMGR22898A JMGR22901 3.204kg/m	套芯配JMGR22902 JMGR22901 85 15.5 14.8 2.5 75 131	13	JMGR22906 0.295kg/m	10.8 3 37.17	22		
5	JMGR22898A JMGR22903 3.353kg/m	套芯配JMGR22904 JMGR22903 85 15.5 14.8 2.5 75 131	14	JMGR22905 0.397kg/m	1.5 28.25 50.7	23		
6	JMGR22902 2.228kg/m	79 69 3	15	JMGR22910 0.229kg/m	43 1.2 12	24		
7	JMGR22904 2.228kg/m	69 79 3	16	PC5086 1.543kg/m	40 8.4 40	25		
8	JMGR22907 0.880kg/m	角码配PC5086 50.1 1.8 8.7 50	17			26		
9	JMGR22908 0.922kg/m	角码配PC5086 43.3 1.8 8.7 50	18			27		

图中所示型材截面、装配、编号、尺寸及重量仅供参考。如有疑问，请向本公司查询。
Information above just for your reference. Please contact us if you have any questions, Thank you!

图中所示型材截面、装配、编号、尺寸及重量仅供参考。如有疑问，请向本公司查询。
Information above just for your reference. Please contact us if you have any questions, Thank you!

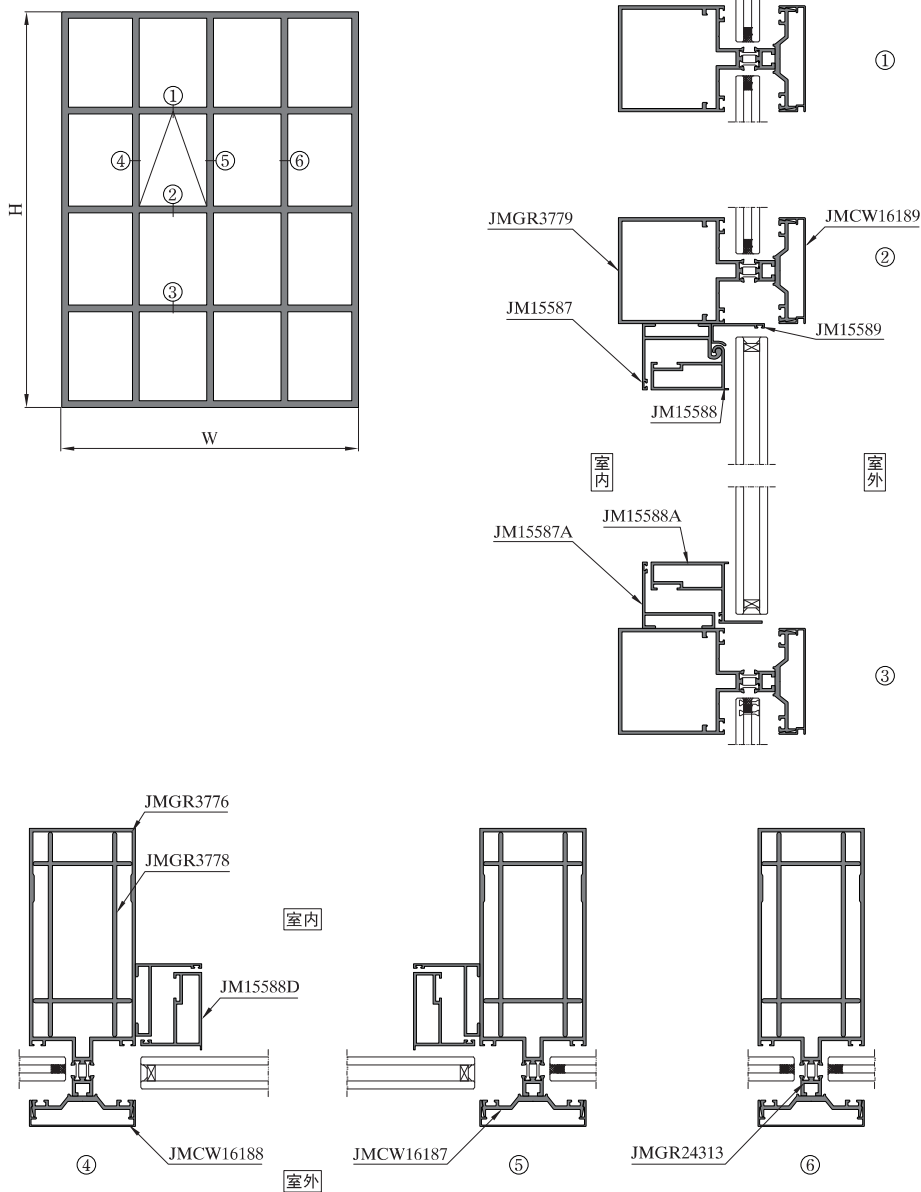

序号 S/N	型号理论重量 JMA Code & KG/M	型材图 Drawing	序号 S/N	型号理论重量 JMA Code & KG/M	型材图 Drawing	序号 S/N	型号理论重量 JMA Code & KG/M	型材图 Drawing
1	JMGR3776 JMGR24313 4.414kg/m		10	JMGR3778 3.893kg/m		19	JMCW16187 0.912kg/m	
2	JMGR3780 JMGR24313 3.319kg/m		11	JMGR3777 4.244kg/m		20	JMCW16152 0.775kg/m	
3	JMGR3781 4.076kg/m		12	JM15587 1.023kg/m		21	JMGR3820 2.448kg/m	
4	JMGR3775 4.369kg/m		13	JM15587A 0.760kg/m		22	JMGR3821 1.471kg/m	
5	JMGR21236 JMGR21237 4.266kg/m		14	JM15588 1.025kg/m		23	JMCW16188 0.457kg/m	
6	JMGR3779 JMGR24313 3.146kg/m		15	JM15588A 1.213kg/m		24	JMCW16189 0.457kg/m	
7	JMGR21239 JMGR21237 3.902kg/m		16	JM15588D 1.080kg/m		25	JMCW16153 0.499kg/m	
8	JMGR21251 0.246kg/m		17	JM15589 0.288kg/m		26	JM5004A 2.354kg/m	
9	JMGR20935 3.078kg/m		18	MQ17006A 0.664kg/m		27		

图中所示型材截面、装配、编号、尺寸及重量仅供参考。如有疑问，请向本公司查询。
Information above just for your reference. Please contact us if you have any questions, Thank you!

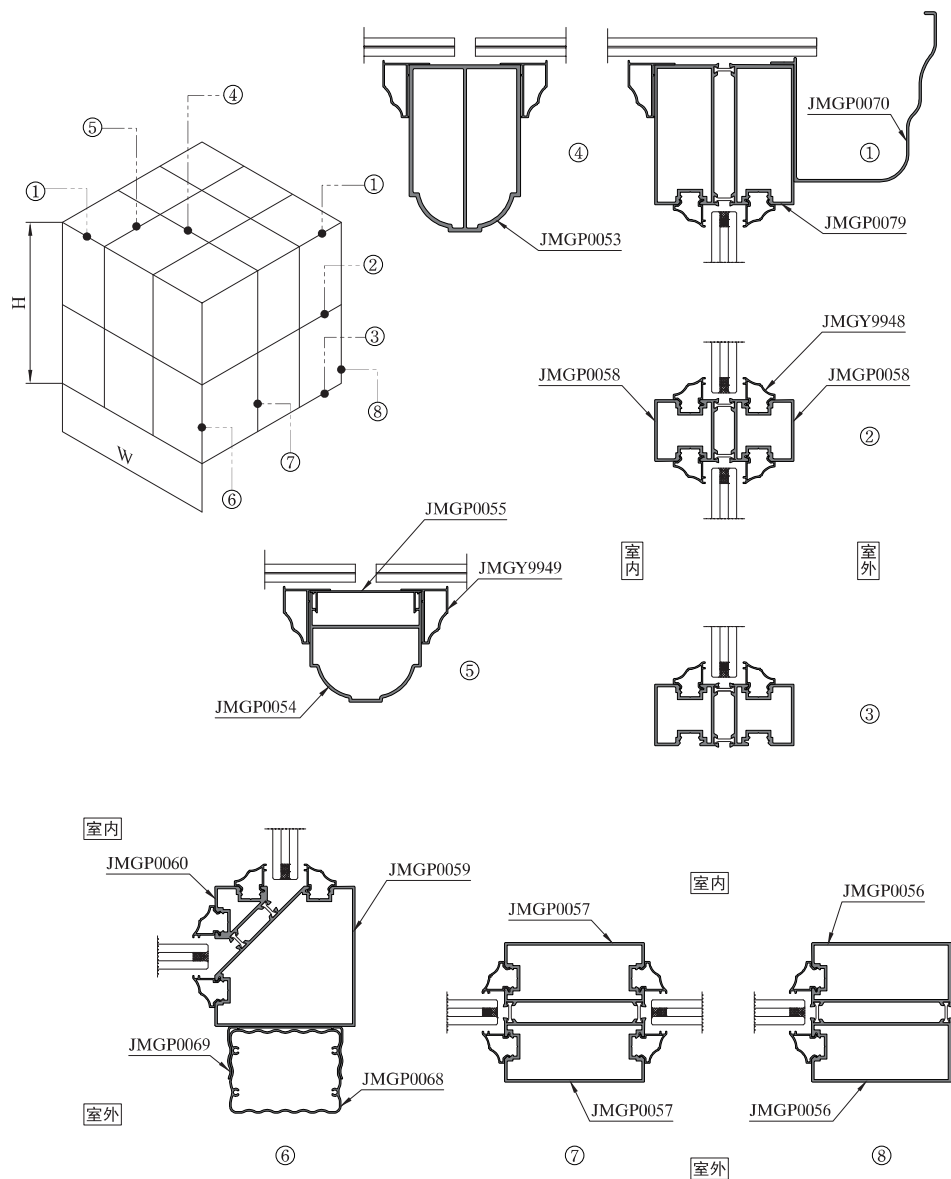

图中所示型材截面、装配、编号、尺寸及重量仅供参考。如有疑问，请向本公司查询。
Information above just for your reference. Please contact us if you have any questions, Thank you!



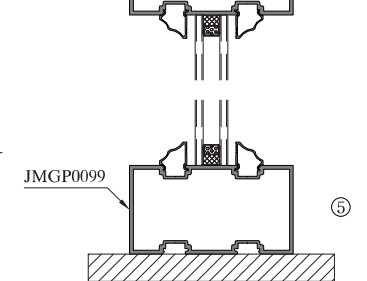
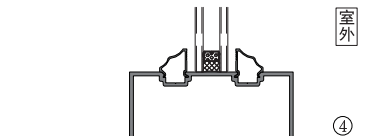
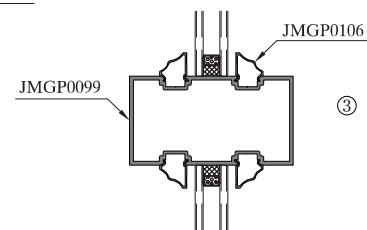
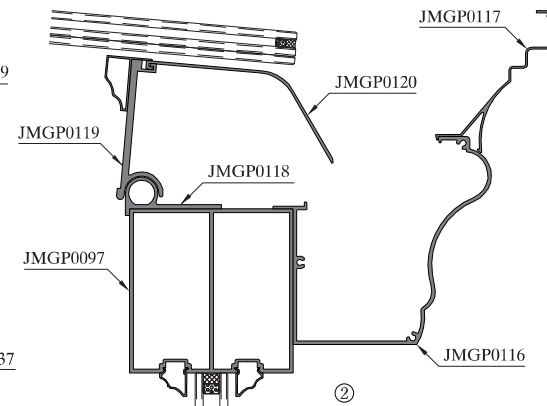
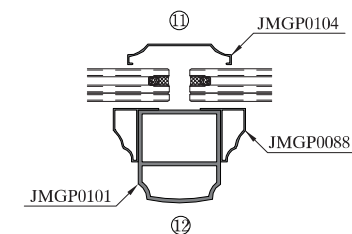
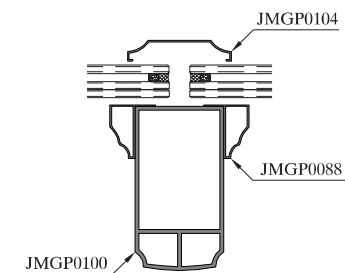
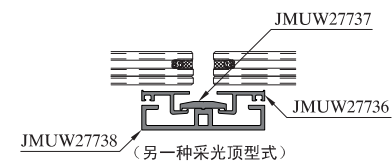
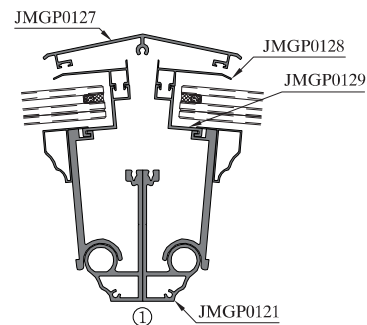
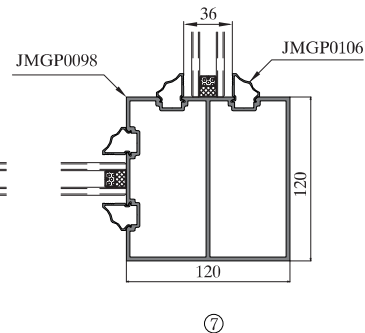
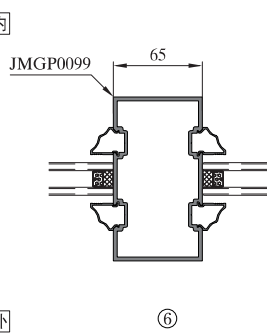
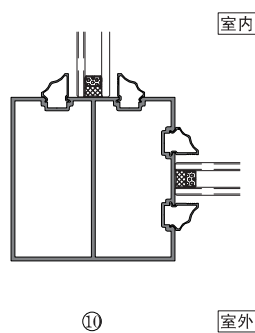
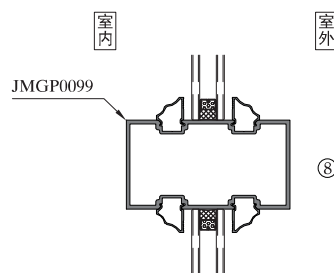
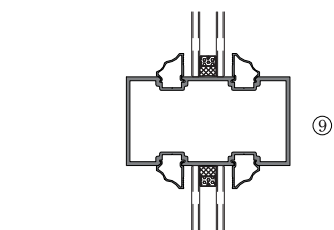
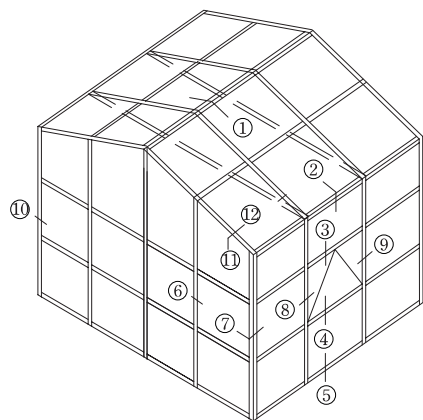

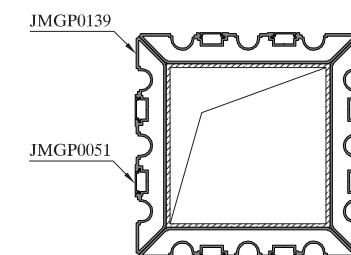
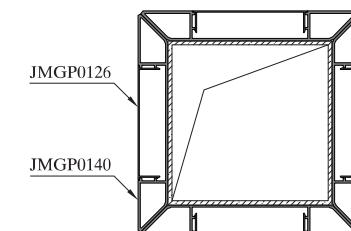
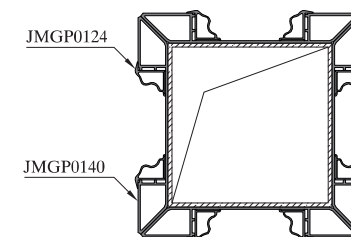
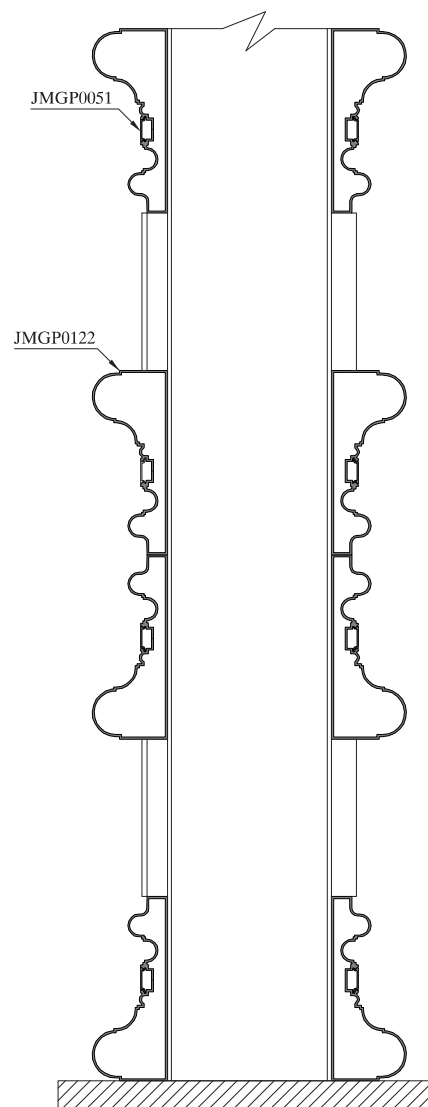
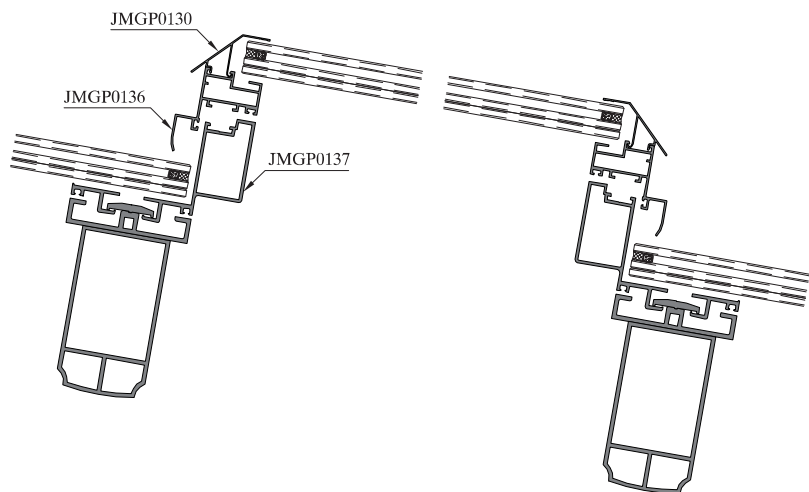
序号 S/N	型号理论重量 JMA Code & KG/M	型材图 Drawing	序号 S/N	型号理论重量 JMA Code & KG/M	型材图 Drawing	序号 S/N	型号理论重量 JMA Code & KG/M	型材图 Drawing
1	JMGP0053 3.672kg/m		10	JMGY9948 0.178kg/m		19		
2	JMGP0054 1.632kg/m		11	JMGY9949 0.422kg/m		20		
3	JMGP0055 0.374kg/m		12	JMGY9950 0.092kg/m		21		
4	JMGP0056 3.657kg/m		13	JMGP0068 1.091kg/m 配JMGP0069		22		
5	JMGP0057 3.804kg/m		14	JMGP0069 0.552kg/m		23		
6	JMGP0058 2.620kg/m		15	JMGP0070 2.179kg/m		24		
7	JMGP0059 3.370kg/m		16	JMGP0079 4.078kg/m		25		
8	JMGY9947 1.105kg/m		17			26		
9	JMGY9946 0.515kg/m		18			27		

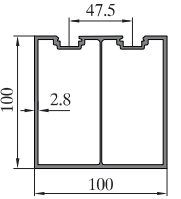
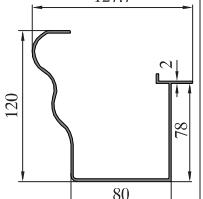
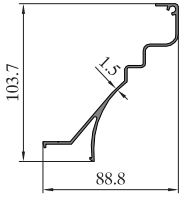
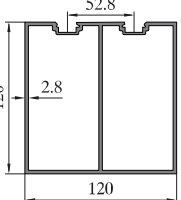
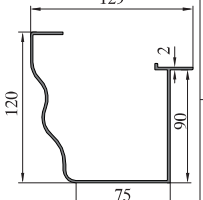
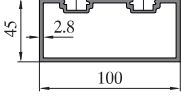
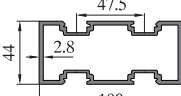
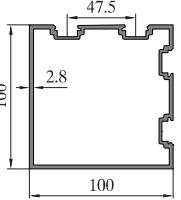
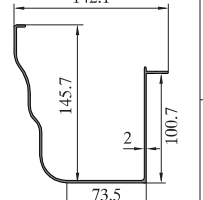
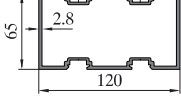
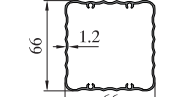
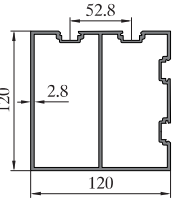
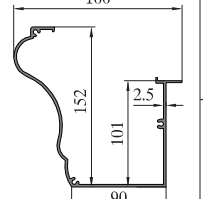
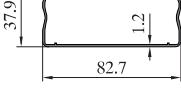
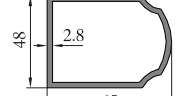
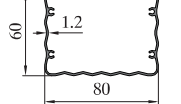
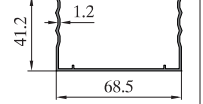

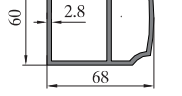
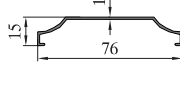
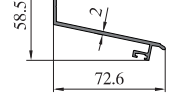
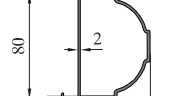
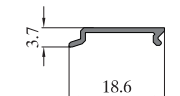
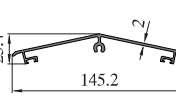
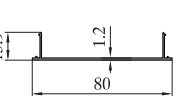
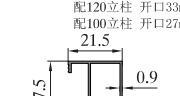
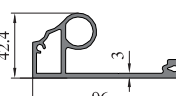

序号 S/N	型号理论重量 JMA Code & KG/M	型材图 Drawing	序号 S/N	型号理论重量 JMA Code & KG/M	型材图 Drawing	序号 S/N	型号理论重量 JMA Code & KG/M	型材图 Drawing
1	立柱 JMGP0040 T=2.8 3.688kg/m		6	排水槽 JMGP0046 T=2.0 1.993kg/m		11	排水槽 JMGP0117 T=1.5 0.953kg/m	
2	立柱 JMGP0097 T=2.8 4.935kg/m		7	排水槽 JMGP0089 T=2.0 2.062kg/m		12	侧梁 JMGP0042 T=2.8 2.445kg/m	
						13	中柱 JMGP0043 T=2.8 2.589kg/m	
3	转角 JMGP0041 T=2.8 3.507kg/m		8	排水槽 JMGP0070 T=2.0 2.179kg/m		14	中柱 JMGP0099 T=2.8 3.252kg/m	
						15	排水管 JMGP0049 T=1.20 1.001kg/m	
4	转角 JMGP0098 T=2.8 5.091kg/m		9	排水槽 JMGP0116 T=2.5 3.197kg/m		16	底座 JMGP0069 T=1.20 0.552kg/m	
						17	副梁 JMGP0044 T=2.8 1.629kg/m	
5	排水管 JMGP0068 T=1.20 1.091kg/m		10	底座 JMGP0048 T=1.20 0.541kg/m		18	副梁 JMGP0101 T=2.0 1.709kg/m	

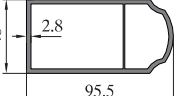
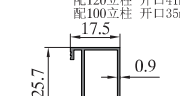
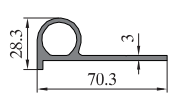
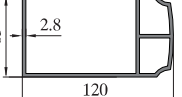
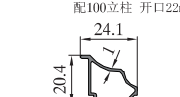
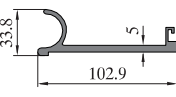
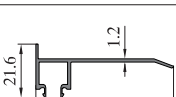
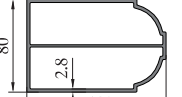
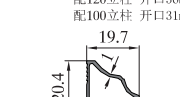
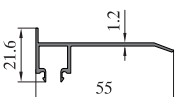
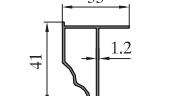
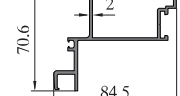
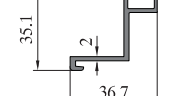
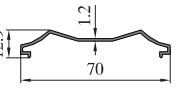
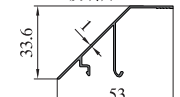
序号 S/N	型号理论重量 JMA Code & KG/M	型材图 Drawing	序号 S/N	型号理论重量 JMA Code & KG/M	型材图 Drawing	序号 S/N	型号理论重量 JMA Code & KG/M	型材图 Drawing
19	副梁 JMGP0094 T=2.8 2.353kg/m		28	玻璃盖板 JMGP0104 T=1.2 0.346kg/m		37	顶盖 JMGP0138 T=2.0 0.747kg/m	
20	副梁 JMGP0054 T=2.0 1.632kg/m		29	封盖 JMGP0051 T=0.9 0.062kg/m		38	顶盖 JMGP0127 T=2.0 1.250kg/m	
21	副梁盖板 JMGP0055 T=1.2 0.374kg/m		30	压线 JMGP0050 T=0.9 0.221kg/m		39	顶梁附件 JMGP0121 T=3.0 2.033kg/m	
						40	顶梁附件 JMGP0118 T=3.0 1.075kg/m	
22	大副梁 JMGP0045 T=2.8 2.278kg/m		31	压线 JMGP0052 T=0.9 0.212kg/m		41	顶梁附件 JMGP0119 T=5.0 1.975kg/m	
23	大副梁 JMGP0100 T=2.8 3.527kg/m		32	压线 JMGP0107 T=1.0 0.177kg/m		42	顶梁附件 JMGP0128 T=1.2 0.328kg/m	
						43	顶梁附件 JMGP0129 T=2.0 0.448kg/m	
24	大副梁 JMGP0053 T=2.8 3.672kg/m		33	压线 JMGP0106 T=1.0 0.159kg/m		44	挡水 JMGP0120 T=2.0 1.047kg/m	
25	装饰条 JMGP0047 T=1.2 0.418kg/m		34	天窗框 JMGP0137 T=2.0 1.645kg/m		45	装饰条 JMGP0124 T=1.2 0.238kg/m	
27	玻璃盖板 JMGP0103 T=1.2 0.322kg/m		36	压线 JMGP0130 T=1.0 0.302kg/m				

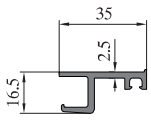
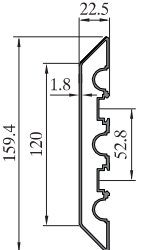
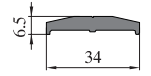
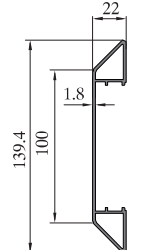
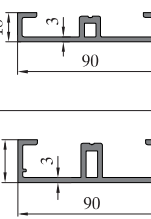
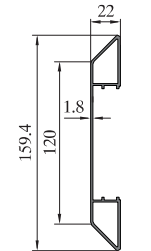
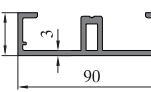
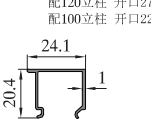
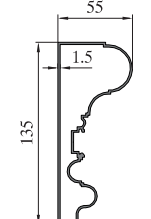
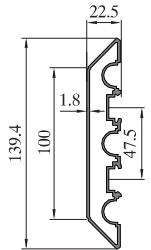
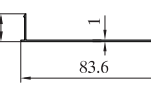
序号 S/N	型号理论重量 JMA Code & KG/M	型材图 Drawing	序号 S/N	型号理论重量 JMA Code & KG/M	型材图 Drawing	序号 S/N	型号理论重量 JMA Code & KG/M	型材图 Drawing
46	玻璃框 JMUW27736 T=2.5 0.477kg/m		53	罗马线 JMGP0139 T=1.8 2.052kg/m		59		
47	压块 JMUW27737 T=0.455kg/m		54	罗马线 JMGP0125 T=1.8 1.308kg/m		60		
48	端头 JMUW27738 T=3.0 1.524kg/m		55	罗马线 JMGP0140 T=1.8 1.518kg/m		61		
49	端头 JMUW27740 T=3.0 1.823kg/m		56	压线 JMGY23894 T=1.0 0.201kg/m		62		
50	罗马线 JMGP0122 T=1.5 1.769kg/m		57			63		
51	罗马线 JMGP0123 T=1.8 1.834kg/m		58			64		
52	盖板 JMGP0126 T=1.0 0.325kg/m					65		

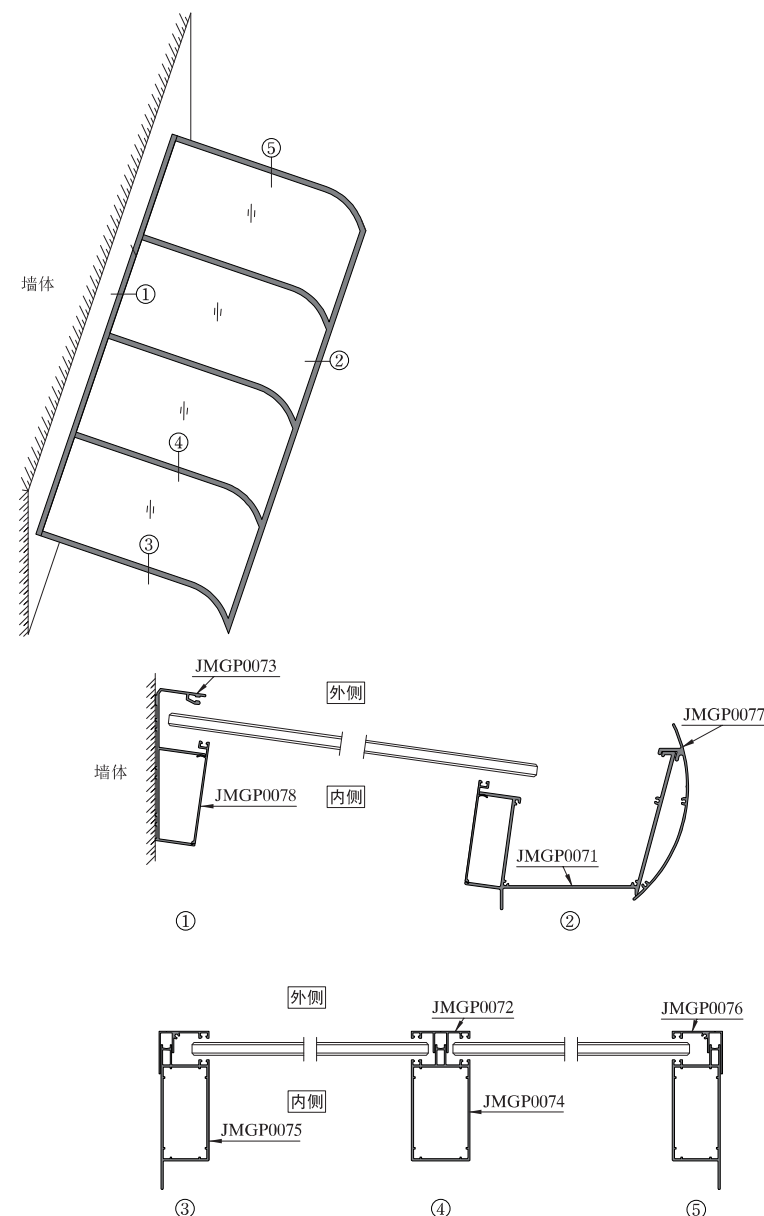

图中所示型材截面、装配、编号、尺寸及重量仅供参考。如有疑问，请向本公司查询。
 Information above just for your reference. Please contact us if you have any questions, Thank you!

图中所示型材截面、装配、编号、尺寸及重量仅供参考。如有疑问，请向本公司查询。
 Information above just for your reference. Please contact us if you have any questions, Thank you!

序号 S/N	型号理论重量 JMA Code & KG/M	型材图 Drawing	序号 S/N	型号理论重量 JMA Code & KG/M	型材图 Drawing	序号 S/N	型号理论重量 JMA Code & KG/M	型材图 Drawing
1	JMGP0071 3.651kg/m		10			19		
2	JMGP0072 0.517kg/m		11			20		
3	JMGP0073 1.787kg/m		12			21		
4	JMGP0074 2.022kg/m		13			22		
5	JMGP0075 2.006kg/m		14			23		
6	JMGP0076 0.558kg/m		15			24		
7	JMGP0077 1.481kg/m		16			25		
8	JMGP0078 0.532kg/m		17			26		
9			18			27		

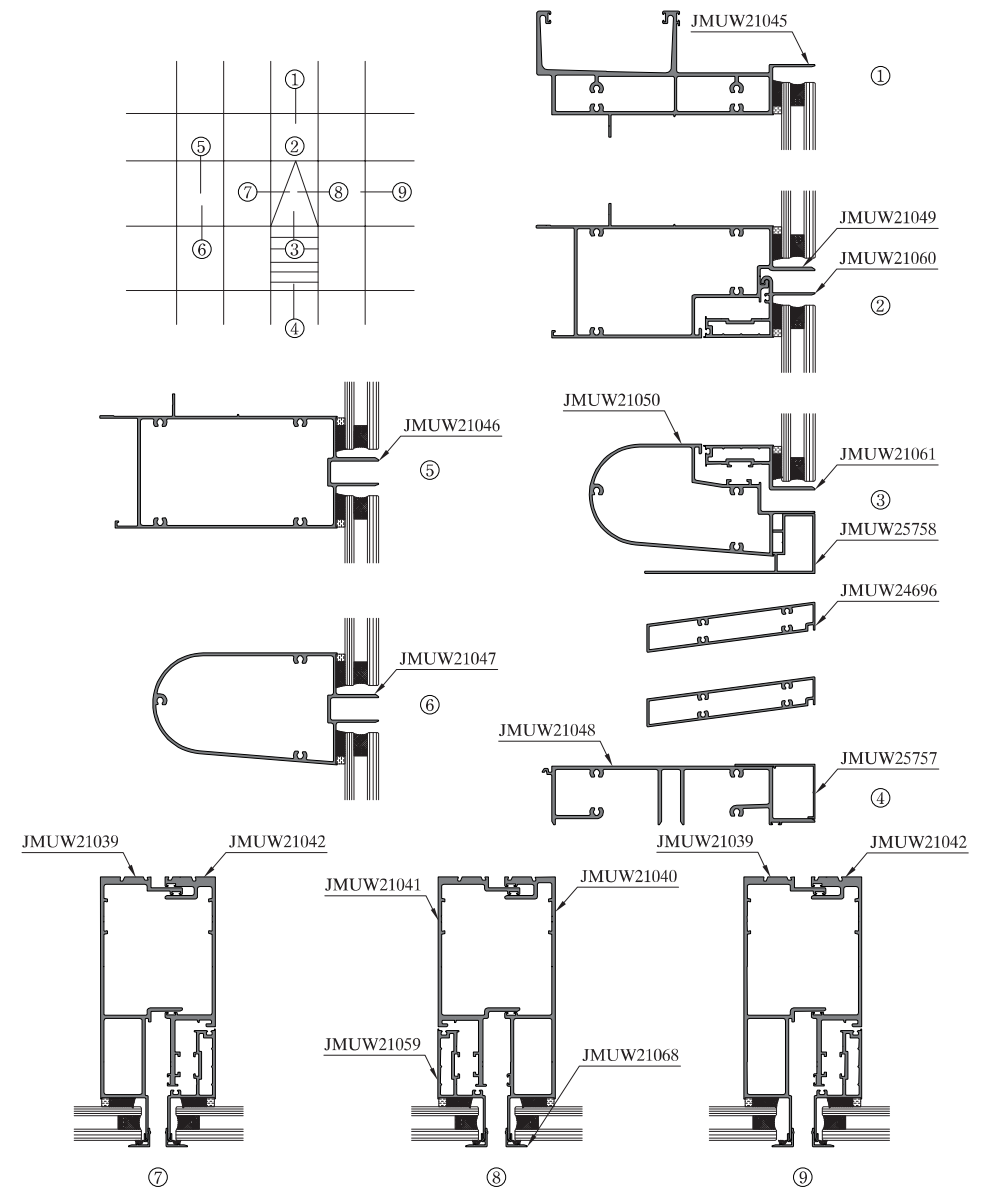

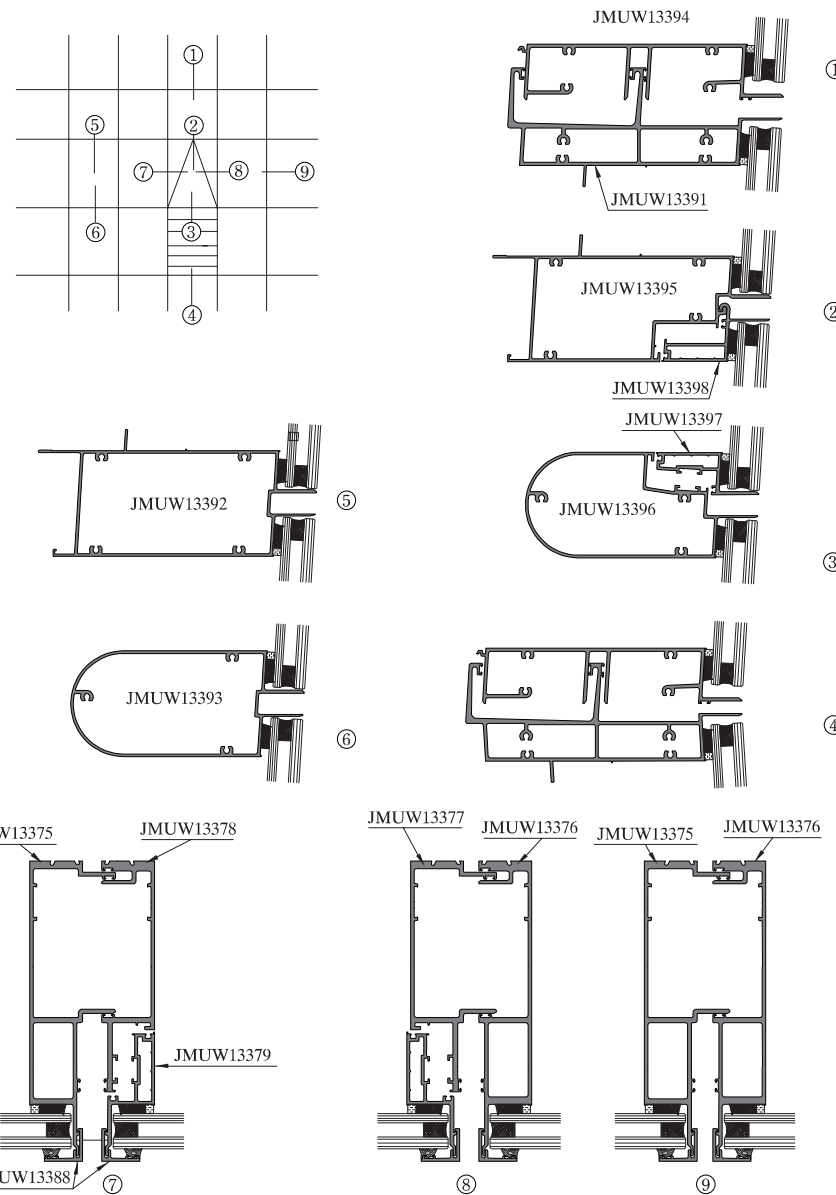

序号 S/N	型号理论重量 JMA Code & KG/M	型材图 Drawing	序号 S/N	型号理论重量 JMA Code & KG/M	型材图 Drawing	序号 S/N	型号理论重量 JMA Code & KG/M	型材图 Drawing
1	JMUW21041 3.966kg/m		10	JMUW21047 4.523kg/m		19	JMUW24697 1.860kg/m	
2	JMUW21042 3.918kg/m		11	JMUW25754 0.507kg/m		20	JMUW24696 2.408kg/m	
3	JMUW21039 4.734kg/m		12	JMUW25758 1.743kg/m		21		
4	JMUW21040 4.430kg/m		13	JMUW21059 1.662kg/m		22		
5	JMUW21048 5.067kg/m		14	JMUW21061 1.716kg/m		23		
6	JMUW21045 7.504kg/m		15	JMUW21060 1.818kg/m		24		
7	JMUW21046 5.660kg/m		16	JMUW21058 1.669kg/m		25		
8	JMUW21049 5.604kg/m		17	JMUW21068 0.184kg/m		26		
9	JMUW21050 4.253kg/m		18	JMUW25757 0.554kg/m		27		

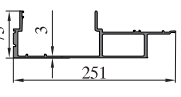
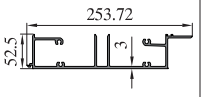
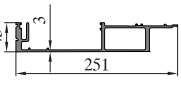
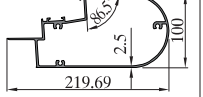
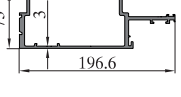
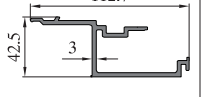
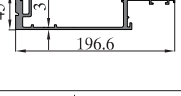
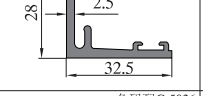
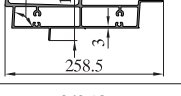
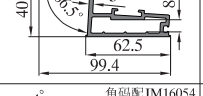
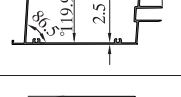
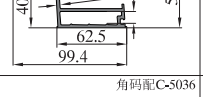
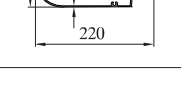
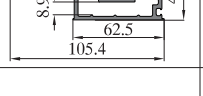
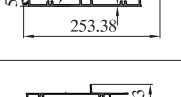
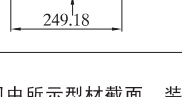

图中所示型材截面、装配、编号、尺寸及重量仅供参考。如有疑问，请向本公司查询。
Information above just for your reference. Please contact us if you have any questions, Thank you!

图中所示型材截面、装配、编号、尺寸及重量仅供参考。如有疑问，请向本公司查询。
Information above just for your reference. Please contact us if you have any questions, Thank you!

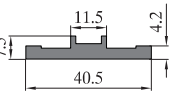
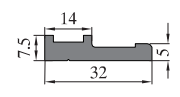
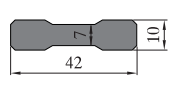
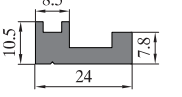
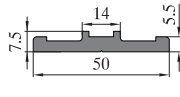
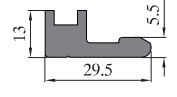
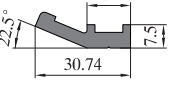
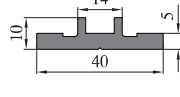
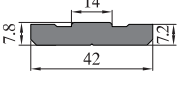
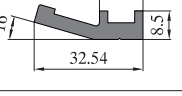
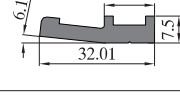
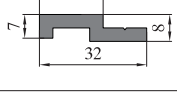
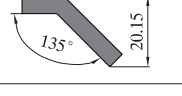
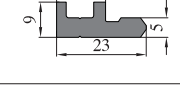
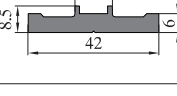
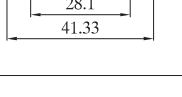
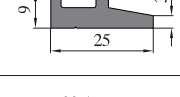
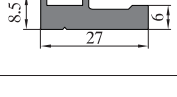
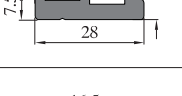
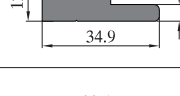
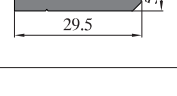
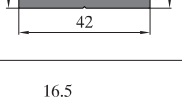
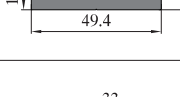
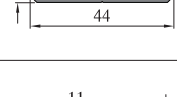
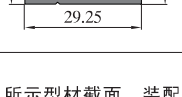
序号 S/N	型号理论重量 JMA Code & KG/M	型材图 Drawing	序号 S/N	型号理论重量 JMA Code & KG/M	型材图 Drawing	序号 S/N	型号理论重量 JMA Code & KG/M	型材图 Drawing
1	JMUW13375 5.398kg/m		10	JMUW13490 5.161kg/m		19		
2	JMUW13376 5.368kg/m		11	JMUW13396 4.783kg/m		20		
3	JMUW13377 4.223kg/m		12	JMUW13380 1.791kg/m		21		
4	JMUW13378 4.033kg/m		13	JMUW13388 0.523kg/m		22		
5	JMUW13391 7.743kg/m		14	JMUW13397 1.809kg/m		23		
6	JMUW13392 5.912kg/m		15	JMUW13398 1.799kg/m		24		
7	JMUW13393 4.972kg/m		16	JMUW13379 1.821kg/m		25		
8	JMUW13394 5.168kg/m		17			26		
9	JMUW13395 5.880kg/m		18			27		

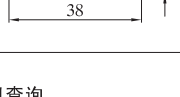
序号 S/N	型号理论重量 JMA Code & KG/M	型材图 Drawing	序号 S/N	型号理论重量 JMA Code & KG/M	型材图 Drawing	序号 S/N	型号理论重量 JMA Code & KG/M	型材图 Drawing
1	A165-10 0.510kg/m		10	W165-16A 0.465kg/m		19	JM11007 1.070kg/m	
2	A165-18 0.462kg/m		11	W165-16B 0.718kg/m		20	JM11016 0.598kg/m	
3	W165-21A 0.465kg/m		12	W165-16C 0.632kg/m		21	JM11016B 0.870kg/m	
4	W165-21B 0.495kg/m		13	W165-21 0.472kg/m		22	JM11016C 0.456kg/m	
5	W165-21C 0.490kg/m		14	QX-YK2 0.381kg/m		23	JM11016E 0.699kg/m	
6	W165-21D 0.325kg/m		15	QX-YK3 0.399kg/m		24	JM11016F 0.465kg/m	
7	W126-5 0.421kg/m		16	QXA-YK1 0.757kg/m		25	JM12505 0.367kg/m	
8	W-1509 0.799kg/m		17	QXA-YK2 0.972kg/m		26	JM12505A 0.545kg/m	
9	W-1509A 0.578kg/m		18	QXA-YK5 0.578kg/m		27	JM12505B 0.475kg/m	

图中所示型材截面、装配、编号、尺寸及重量仅供参考。如有疑问，请向本公司查询。
 Information above just for your reference. Please contact us if you have any questions, Thank you!

图中所示型材截面、装配、编号、尺寸及重量仅供参考。如有疑问，请向本公司查询。
 Information above just for your reference. Please contact us if you have any questions, Thank you!

序号 S/N	型号理论重量 JMA Code & KG/M	型材图 Drawing	序号 S/N	型号理论重量 JMA Code & KG/M	型材图 Drawing	序号 S/N	型号理论重量 JMA Code & KG/M	型材图 Drawing
28	JM12505C 0.336kg/m		37	JM14042 0.491kg/m		46	JM17020 0.483kg/m	
29	JM13806 0.794kg/m		38	JM14047 0.365kg/m		47	JM17020A 0.337kg/m	
30	JM13806A 0.572kg/m		39	JM15087 0.620kg/m		48	JM17070 0.820kg/m	
31	JM13828 0.583kg/m		40	JM15087A 0.430kg/m		49	JM17070A 0.616kg/m	
32	JM13829 0.820kg/m		41	JM16048 0.752kg/m		50	MQ13126 0.570kg/m	
33	JM13879 1.782kg/m		42	JM16049 0.369kg/m		51	MQ13126A 0.456kg/m	
34	JM13879A 0.630kg/m		43	JM16070 0.889kg/m		52	MQ14008 0.531kg/m	
35	JM13879B 0.807kg/m		44	JM16070A 0.557kg/m		53	MQ14008A 0.482kg/m	
36	JM13879C 1.236kg/m		45	MQ10006 0.323kg/m		54	MQ140A88 0.485kg/m	

序号 S/N	型号理论重量 JMA Code & KG/M	型材图 Drawing	序号 S/N	型号理论重量 JMA Code & KG/M	型材图 Drawing	序号 S/N	型号理论重量 JMA Code & KG/M	型材图 Drawing
55	MQ140A88A 0.612kg/m		64	MQ160A20 0.473kg/m		73	MQ17009 1.522kg/m	
56	MQ140A88B 0.463kg/m		65	MQ160A20A 0.606kg/m		74	MQ17050 1.523kg/m	
57	MQ140A88C 0.629kg/m		66	MQ160A50 0.453kg/m		75	MQ17051 2.080kg/m	
58	MQ15017 0.483kg/m		67	MQ160A50A 0.585kg/m		76	MQ17052 2.209kg/m	
59	MQ15017A 0.770kg/m		68	MQ160A50B 0.616kg/m		77	MQ180015 0.860kg/m	
60	MQ15021 1.304kg/m		69	MQ160A50C 0.990kg/m		78	MQ18057 0.669kg/m	
61	MQ15041 0.856kg/m		70	MQ160A50D 0.700kg/m		79	MQ18090 0.301kg/m	
62	MQ15079 0.451kg/m		71	MQ160A50E 0.521kg/m		80	MQ18090A 0.436kg/m	
63	MQ15079A 0.585kg/m		72	MQ160A79 0.404kg/m		81	MQ18090B 0.254kg/m	

图中所示型材截面、装配、编号、尺寸及重量仅供参考。如有疑问，请向本公司查询。
Information above just for your reference. Please contact us if you have any questions, Thank you!

图中所示型材截面、装配、编号、尺寸及重量仅供参考。如有疑问，请向本公司查询。
Information above just for your reference. Please contact us if you have any questions, Thank you!

序号 S/N	型号理论重量 JMA Code & KG/M	型材图 Drawing	序号 S/N	型号理论重量 JMA Code & KG/M	型材图 Drawing	序号 S/N	型号理论重量 JMA Code & KG/M	型材图 Drawing
82	MQ18090C 0.386kg/m		91	MQ80157A 1.001kg/m		100	JMGR2889 0.539kg/m	
83	MQ180A09 0.745kg/m		92	MQ80157B 0.906kg/m		101	JMCW06260 0.778kg/m	
84	MQ180A09A 0.544kg/m		93	MQ80157C 0.921kg/m		102	JMCW06260A 1.071kg/m	
85	MQ180A09B 0.681kg/m		94	JMGR0168 0.449kg/m		103	JMCW09180 0.514kg/m	
86	MQ188010 0.672kg/m		95	JMGR0168A 0.610kg/m		104	JMCW09181 0.382kg/m	
87	MQ188010A 0.510kg/m		96	JMGR0168B 0.607kg/m		105	JMCW09511 0.451kg/m	
88	MQ80048 0.451kg/m		97	JMGR21442 0.640kg/m		106	JMCW09512 0.676kg/m	
89	MQ80048A 0.611kg/m		98	JMGR21443 0.461kg/m		107	JMCW18363 0.632kg/m	
90	MQ80157 1.024kg/m		99	JMGR2888 0.410kg/m		108	JMCW18364 0.442kg/m	



序号 S/N	型号理论重量 JMA Code & KG/M	型材图 Drawing	序号 S/N	型号理论重量 JMA Code & KG/M	型材图 Drawing	序号 S/N	型号理论重量 JMA Code & KG/M	型材图 Drawing
1	JM11008 0.646kg/m		10	JM11008H 0.761kg/m		19	JM13805RA 0.492kg/m	
2	JM11008A 0.529kg/m		11	JM11008J 0.523kg/m		20	JM13825 0.624kg/m	
3	JM11008E 0.596kg/m		12	JM11066A 0.409kg/m		21	JM13825A 0.624kg/m	
4	JM11008F 0.703kg/m		13	JM12506 0.470kg/m		22	JM13877 1.437kg/m	
5	JM11008G 0.589kg/m		14	JM12506A 0.434kg/m		23	JM13877A 1.023kg/m	
6	JM11008K 0.564kg/m		15	JM12506B 0.434kg/m		24	JM13877B 1.139kg/m	
7	JM11008L 0.704kg/m		16	JM130049 0.364kg/m		25	JM13877C 0.596kg/m	
8	JM11008M 0.615kg/m		17	JM13805 0.638kg/m		26	JM13877D 0.637kg/m	
9	JM11008D 0.612kg/m		18	JM13805A 0.504kg/m		27	JM13877E 0.930kg/m	





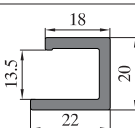
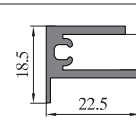
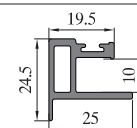
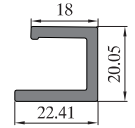
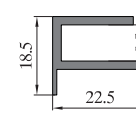
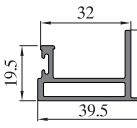
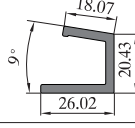
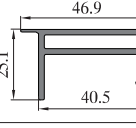
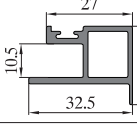
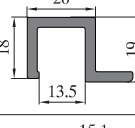
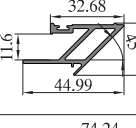
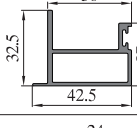
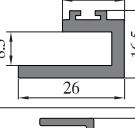
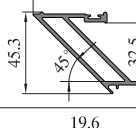
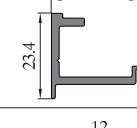
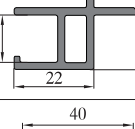
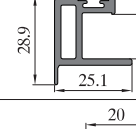
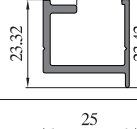
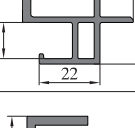
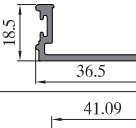
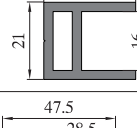
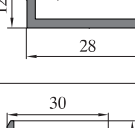
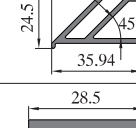
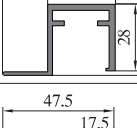
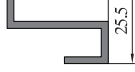
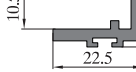

图中所示型材截面、装配、编号、尺寸及重量仅供参考。如有疑问，请向本公司查询。
Information above just for your reference. Please contact us if you have any questions, Thank you!

图中所示型材截面、装配、编号、尺寸及重量仅供参考。如有疑问，请向本公司查询。
Information above just for your reference. Please contact us if you have any questions, Thank you!

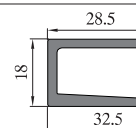
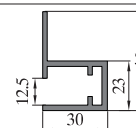
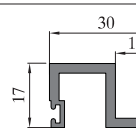
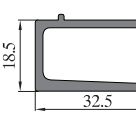
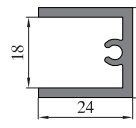
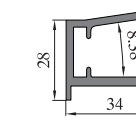
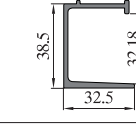
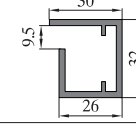
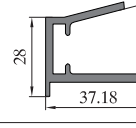
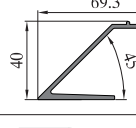
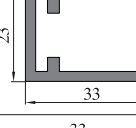
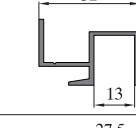
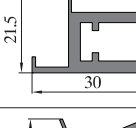
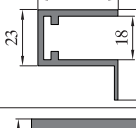
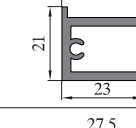
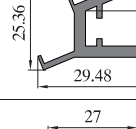
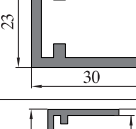
序号 S/N	型号理论重量 JMA Code & KG/M	型材图 Drawing	序号 S/N	型号理论重量 JMA Code & KG/M	型材图 Drawing	序号 S/N	型号理论重量 JMA Code & KG/M	型材图 Drawing
28	JM13877F 0.607kg/m		37	JM15059A 0.597kg/m		46	JM16069 0.567kg/m	
29	JM14039 0.663kg/m		38	JM15059B 0.480kg/m		47	JM16069A 0.659kg/m	
30	JM14039A 0.829kg/m		39	JM15084 0.589kg/m		48	JM17021 0.467kg/m	
31	JM14059 0.630kg/m		40	JM15084A 0.791kg/m		49	JM17021A 0.370kg/m	
32	JM14062 0.507kg/m		41	JM15084C 0.442kg/m		50	JM17021C 0.596kg/m	
33	JM14062B 0.447kg/m		42	JM15084D 0.490kg/m		51	JM17021D 0.401kg/m	
34	JM15008 0.581kg/m		43	JM15095 0.563kg/m		52	JM17021E 0.677kg/m	
35	JM15008A 0.597kg/m		44	JM16045 0.600kg/m		53	JM17069B 0.691kg/m	
36	JM15059 0.582kg/m		45	JM16045A 0.545kg/m		54	JM13877G 0.572kg/m	

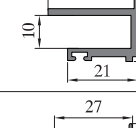
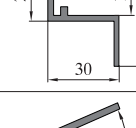
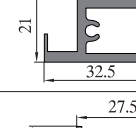
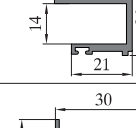
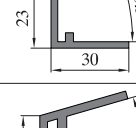
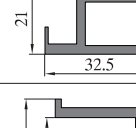
序号 S/N	型号理论重量 JMA Code & KG/M	型材图 Drawing	序号 S/N	型号理论重量 JMA Code & KG/M	型材图 Drawing	序号 S/N	型号理论重量 JMA Code & KG/M	型材图 Drawing
55	MQ80047 0.495kg/m		64	MQ140A79A 0.552kg/m		73	MQ140A87A 0.973kg/m	
56	MQ80047A 0.549kg/m		65	MQ140A79B 0.598kg/m		74	MQ140A87B 1.08kg/m	
57	MQ80049 0.445kg/m		66	MQ140A79C 0.656kg/m		75	MQ140A87C 0.508kg/m	
58	MQ10005 0.321kg/m		67	MQ140A79D 0.360kg/m		76	MQ140A87D 0.554kg/m	
59	MQ13002 0.598kg/m		68	MQ140A79E 0.546kg/m		77	MQ140A87E 0.680kg/m	
60	MQ13125A 0.374kg/m		69	MQ140A79F 0.423kg/m		78	MQ140A87F 0.630kg/m	
61	MQ14007 0.550kg/m		70	MQ140A79G 0.508kg/m		79	MQ140A87G 0.930kg/m	
62	MQ140A60 0.433kg/m		71	MQ140A79H 0.718kg/m		80	MQ140A87H 0.788kg/m	
63	MQ140A60A 0.644kg/m		72	MQ140A87 0.800kg/m		81	MQ15016 0.411kg/m	

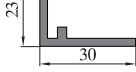
序号 S/N	型号理论重量 JMA Code & KG/M	型材图 Drawing	序号 S/N	型号理论重量 JMA Code & KG/M	型材图 Drawing	序号 S/N	型号理论重量 JMA Code & KG/M	型材图 Drawing
82	MQ15040 0.476kg/m		91	MQ16028B 0.361kg/m		100	MQ160A49A 0.435kg/m	
83	MQ15040A 0.481kg/m		92	MQ16028C 0.310kg/m		101	MQ160A49B 0.567kg/m	
84	MQ15040B 0.524kg/m		93	MQ160A19 0.732kg/m		102	MQ160A49C 0.508kg/m	
85	MQ15044 0.545kg/m		94	MQ160A19B 0.826kg/m		103	MQ160A49D 0.665kg/m	
86	MQ15060 0.462kg/m		95	MQ160A19C 1.117kg/m		104	MQ160A78 0.308kg/m	
87	MQ16007 0.616kg/m		96	MQ160A19D 0.522kg/m		105	MQ160A78A 0.355kg/m	
88	MQ16007A 0.745kg/m		97	MQ160A19F 0.589kg/m		106	MQ160A78B 0.599kg/m	
89	MQ16028 0.296kg/m		98	MQ160A19G 0.650kg/m		107	MQ16510 0.702kg/m	
90	MQ16028A 0.375kg/m		99	MQ160A49 0.532kg/m		108	MQ16511 0.687kg/m	

序号 S/N	型号理论重量 JMA Code & KG/M	型材图 Drawing	序号 S/N	型号理论重量 JMA Code & KG/M	型材图 Drawing	序号 S/N	型号理论重量 JMA Code & KG/M	型材图 Drawing
109	MQ17004C 0.535kg/m		118	W165-15B 0.784kg/m		127	W165-15L 0.474kg/m	
110	MQ17045 0.521kg/m		119	W165-15C 0.527kg/m		128	W165-22 0.710kg/m	
111	MQ17046 0.637kg/m		120	W165-15D 0.770kg/m		129	W165-23 0.746kg/m	
112	MQ17048 0.788kg/m		121	W165-15E 0.676kg/m		130	W165-36 0.339kg/m	
113	MQ18098 0.477kg/m		122	W165-15F 0.738kg/m		131	W-1504 0.507kg/m	
114	MQ18098A 0.486kg/m		123	W165-15G 0.632kg/m		132	W-1504A 0.482kg/m	
115	MQ19047 0.393kg/m		124	W165-15H 0.743kg/m		133	W-1504B 0.606kg/m	
116	MQ19047A 0.417kg/m		125	W165-15J 0.630kg/m		134	W-1504C 0.580kg/m	
117	W165-15 0.648kg/m		126	W165-15K 0.626kg/m		135	W-1504D 0.554kg/m	

图中所示型材截面、装配、编号、尺寸及重量仅供参考。如有疑问，请向本公司查询。
 Information above just for your reference. Please contact us if you have any questions, Thank you!

图中所示型材截面、装配、编号、尺寸及重量仅供参考。如有疑问，请向本公司查询。
 Information above just for your reference. Please contact us if you have any questions, Thank you!

序号 S/N	型号理论重量 JMA Code & KG/M	型材图 Drawing	序号 S/N	型号理论重量 JMA Code & KG/M	型材图 Drawing	序号 S/N	型号理论重量 JMA Code & KG/M	型材图 Drawing
136	Y14507 0.780kg/m		145	Y14521 0.607kg/m		154	OXA-BLK1 0.573kg/m	
137	Y14508 0.780kg/m		146	Y14521A 0.566kg/m		155	OXA-BLK2 0.564kg/m	
138	Y14511 0.637kg/m		147	Y14522 0.607kg/m		156	OXA-BLK6 0.551kg/m	
139	Y14512 0.635kg/m		148	Y14522A 0.566kg/m		157	QX-XK8 0.515kg/m	
140	Y14513 1.133kg/m		149	H1405 0.387kg/m		158	OXA-LBK1 0.564kg/m	
141	Y14514 1.133kg/m		150	H1405A 0.528kg/m		159	K013 0.451kg/m	
142	Y14518 0.742kg/m		151	H1405B 0.422kg/m		160	LBM12076 0.442kg/m	
143	Y14519 0.742kg/m		152	H1419 0.510kg/m		161	A165-6 0.519kg/m	
144	Y14520 0.582kg/m		153	H1419A 0.623kg/m		162	JMGR0169 0.423kg/m	

序号 S/N	型号理论重量 JMA Code & KG/M	型材图 Drawing	序号 S/N	型号理论重量 JMA Code & KG/M	型材图 Drawing	序号 S/N	型号理论重量 JMA Code & KG/M	型材图 Drawing
1	JMCW03604 0.174kg/m		10	JMGY6442 0.638kg/m		19	JMCW04057 0.214kg/m	
2	JMCW14591 0.159kg/m		11	JMUW7224 0.837kg/m		20	JMCW04512 1.013kg/m	
3	JMCW14171 0.265kg/m		12	JMUW13140 1.887kg/m		21	JMCW04513 1.011kg/m	
4	MQ140A70K 0.313kg/m		13	JMUW13269 1.777kg/m		22	JMCW05817 1.215kg/m	
5	JMGR3718 0.234kg/m		14	JMCW06315 2.254kg/m		23	JMCW05818 1.580kg/m	
6	JMCW01744 0.456kg/m		15	JMUW16295 12.102kg/m		24	JMCW07645 1.042kg/m	
7	JMUW16623 0.556kg/m		16	JMCW03601 0.916kg/m		25	JMCW07646 2.324kg/m	
8	JMGY10948 0.437kg/m		17	JMCW03602 0.904kg/m		26	JMCW07647 1.230kg/m	
9	JMCW02044 0.449kg/m		18	JMCW03603 2.568kg/m		27	JMCW07648 1.129kg/m	

图中所示型材截面、装配、编号、尺寸及重量仅供参考。如有疑问，请向本公司查询。
Information above just for your reference. Please contact us if you have any questions, Thank you!

图中所示型材截面、装配、编号、尺寸及重量仅供参考。如有疑问，请向本公司查询。
Information above just for your reference. Please contact us if you have any questions, Thank you!

序号 S/N	型号理论重量 JMA Code & KG/M	型材图 Drawing	序号 S/N	型号理论重量 JMA Code & KG/M	型材图 Drawing	序号 S/N	型号理论重量 JMA Code & KG/M	型材图 Drawing
28	JMCW07853 0.989kg/m		37	JMCW10905 1.081kg/m		46	JMCW13021 1.229kg/m	
29	JMCW07854 1.043kg/m		38	JMCW11287 1.233kg/m		47	JMCW14303 1.474kg/m	
30	JMCW07855 2.052kg/m		39	JMCW11288 1.731kg/m		48	JMCW14590 1.152kg/m	
31	JMCW07856 0.847kg/m		40	JMCW11400 1.295kg/m		49	JMCW15230 1.495kg/m	
32	JMCW10846 1.175kg/m		41	JMCW11401 1.663kg/m		50	JMCW16687 0.962kg/m	
33	JMCW10847 1.805kg/m		42	JMCW11403 1.454kg/m		51	JMCW16688 0.671kg/m	
34	JMCW10848 0.904kg/m		43	JMCW11416 0.955kg/m		52	JMCW16689 0.953kg/m	
35	JMCW10849 0.913kg/m		44	JMCW11525 0.374kg/m		53	JMCW16690 1.911kg/m	
36	JMCW10904 1.218kg/m		45	JMCW12540 1.490kg/m		54	JMCW16691 1.304kg/m	

序号 S/N	型号理论重量 JMA Code & KG/M	型材图 Drawing	序号 S/N	型号理论重量 JMA Code & KG/M	型材图 Drawing	序号 S/N	型号理论重量 JMA Code & KG/M	型材图 Drawing
55	JMCW19447 1.499kg/m		64	JMUW6674 1.653kg/m		73	JMUW14479 6.141kg/m	
56	JMCW19448 1.240kg/m		65	JMUW7223 13.950kg/m		74	MQ140A70L 0.775kg/m	
57	JMCW20604 2.725kg/m		66	JMUW12602 1.359kg/m		75	MQ140A70M 0.998kg/m	
58	JMCW20605 1.439kg/m		67	JMUW13138 7.754kg/m		76	MQ180A29E 1.719kg/m	
59	JMCW23155 1.395kg/m		68	JMUW13139 10.540kg/m		77	MQ180A29G 0.877kg/m	
60	JMCW23156 1.466kg/m		69	JMUW13141 17.334kg/m		78	MQ180A29H 0.935kg/m	
61	JMCW23721 1.258kg/m		70	JMUW13142 20.708kg/m		79	JM15059D 0.380kg/m	
62	JMUW6340 1.773kg/m		71	JMUW13244 5.922kg/m		80	JM15059E 0.605kg/m	
63	JMUW6344 1.491kg/m		72	JMUW13245 5.965kg/m		81	JM15059F 0.761kg/m	

图中所示型材截面、装配、编号、尺寸及重量仅供参考。如有疑问，请向本公司查询。
 Information above just for your reference. Please contact us if you have any questions, Thank you!

图中所示型材截面、装配、编号、尺寸及重量仅供参考。如有疑问，请向本公司查询。
 Information above just for your reference. Please contact us if you have any questions, Thank you!

序号 S/N	型号理论重量 JMA Code & KG/M	型材图 Drawing	序号 S/N	型号理论重量 JMA Code & KG/M	型材图 Drawing	序号 S/N	型号理论重量 JMA Code & KG/M	型材图 Drawing
82	JMGR2439 0.998kg/m		91	JMGY6441 2.584kg/m		100	JMGY9842 1.275kg/m	
83	JMGR2440 0.997kg/m		92	JMGY7125 1.264kg/m		101	JMLY0148 1.592kg/m	
84	JMGR2902 1.495kg/m		93	JMGY7819 1.004kg/m		102	JMLY0149 0.975kg/m	
85	JMGR3716 1.391kg/m		94	JMGY7820 0.517kg/m		103	JMLY0150 0.973kg/m	
86	JMGR3717 2.124kg/m		95	JMGY8894 1.159kg/m		104	JMLY0151 0.893kg/m	
87	JMGR21081 1.577kg/m		96	JMGY9837 13.090kg/m		105	JMLY0152 0.831kg/m	
88	JMGR21083 0.887kg/m		97	JMGY9839 15.068kg/m		106	JMLY0153 1.998kg/m	
89	JMGR21734 1.705kg/m		98	JMGY9840 0.843kg/m		107	JMLY0155 0.807kg/m	
90	JMGR21735 1.279kg/m		99	JMGY9841 0.818kg/m		108	JMLY0156 0.636kg/m	

图中所示型材截面、装配、编号、尺寸及重量仅供参考。如有疑问，请向本公司查询。
Information above just for your reference. Please contact us if you have any questions, Thank you!

广东坚美铝型材厂(集团)有限公司

Guangdong JMA Aluminium Profile Factory (Group) Co., Ltd.

地址: 中国广东省佛山市南海区大沥凤池工业区(广佛路大沥往佛山1公里)
ADD: Fengchi Industrial Area, Dali Town, Nanhai District, Foshan City, Guangdong Province, China

佛山坚美铝业有限公司

Foshan JMA Aluminium Co., Ltd.

地址: 广东省佛山市南海区狮山镇桃园西路高新技术开发区南海园
ADD: Nanhai Park, High-new Technology Zone, Tianyuan Road West, Shishan Town, Nanhai District, Foshan City, Guangdong Province, China

邮编(Zip): 528231 电话(Tel): 86-757-85558828 传真(Fax): 86-757-85550238
网址(Website): <http://www.jma.cn> <http://www.jianmei-alu.com>
电子邮箱(E-mail): sales@jma.cn jmmaster@jma.cn dd@jma.cn



坚美铝材
官方网站二维码



坚美铝业微信公众号
微信号: jmagroup